

40 G-90 1F

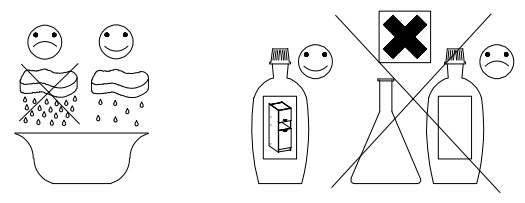

KUH.30008
KUH.40019

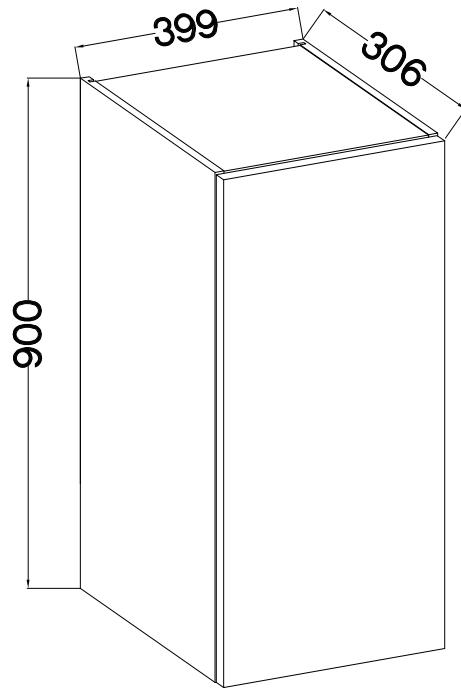

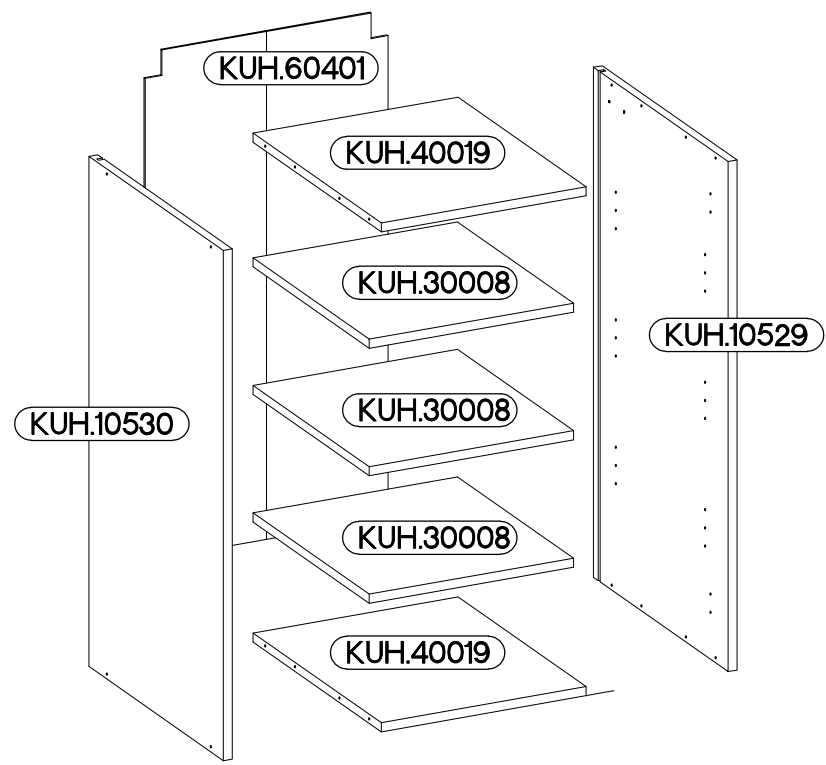
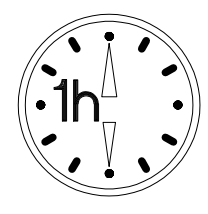

Ersatzteil Nummer	Dimension
KUH.10529	900x290x16
KUH.10530	900x290x16
KUH.30008 x3	366x250x16
KUH.40019 x2	367x276x16
KUH.60401	896x385x2,5

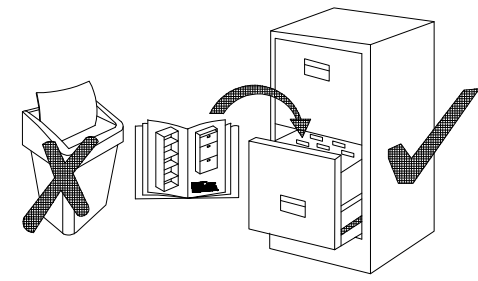
$\pm 8 \times 30\text{mm}$ A 8	$6,4 \times 50\text{mm}$ B 8	E1 8	$\pm 35/0\text{mm}$ [CD] HG 2	$\pm 5/19\text{mm}$ J 12
L K25 1	R K26 1	O 1	$\pm 3.5 \times 13\text{mm}$ P5 4	$\pm 3.0 \times 20\text{mm}$ P7 8-10
			$\pm 4.0 \times 30\text{mm}$ P8 4	



ISM-KUH-01822

1

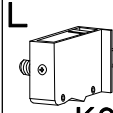
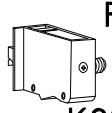
 +8x30mm A	 +4.0x30mm P8	 L K25	 R K26
8	4	1	1

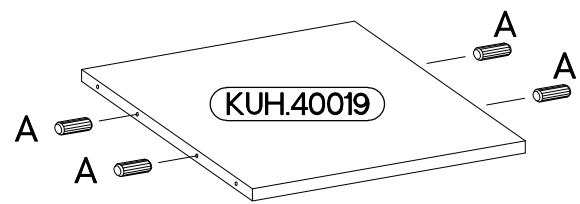
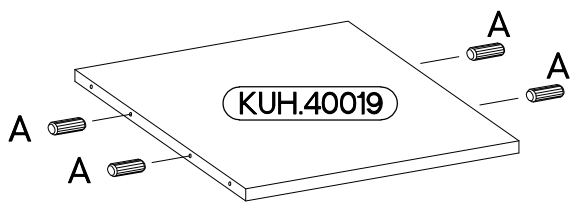
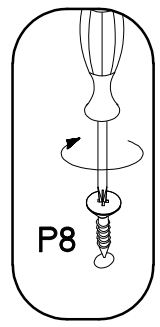
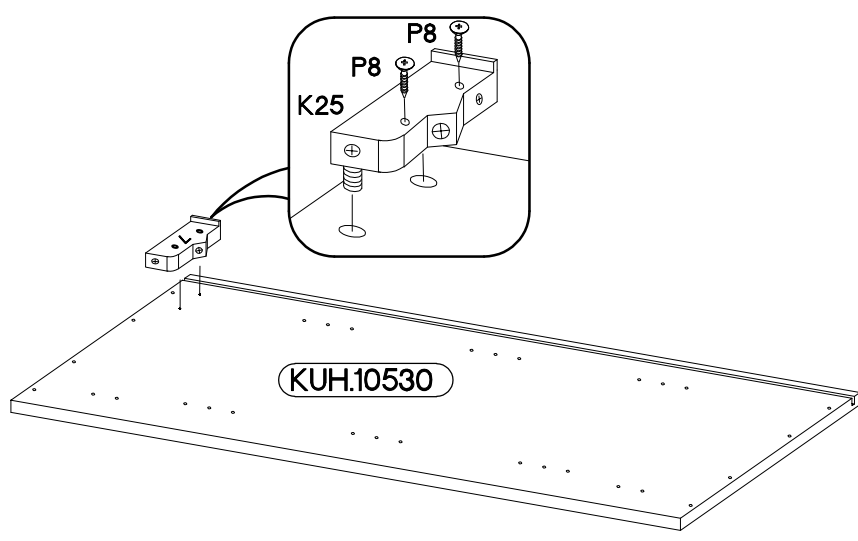
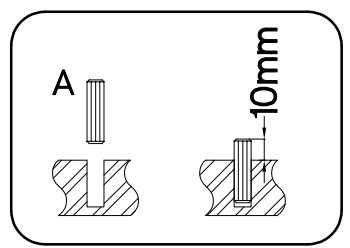
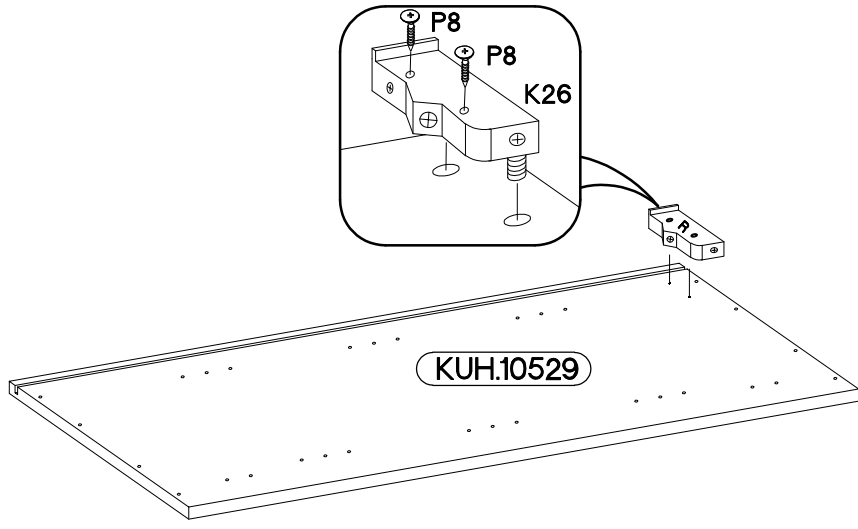
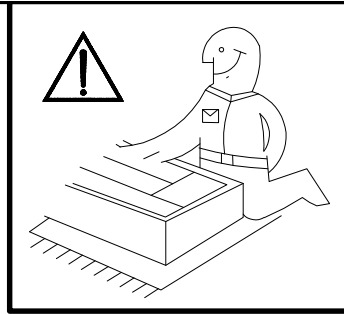



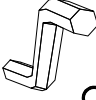
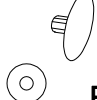

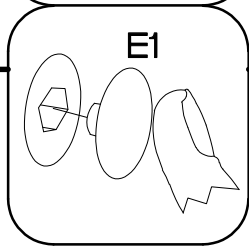
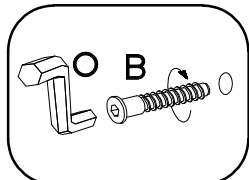
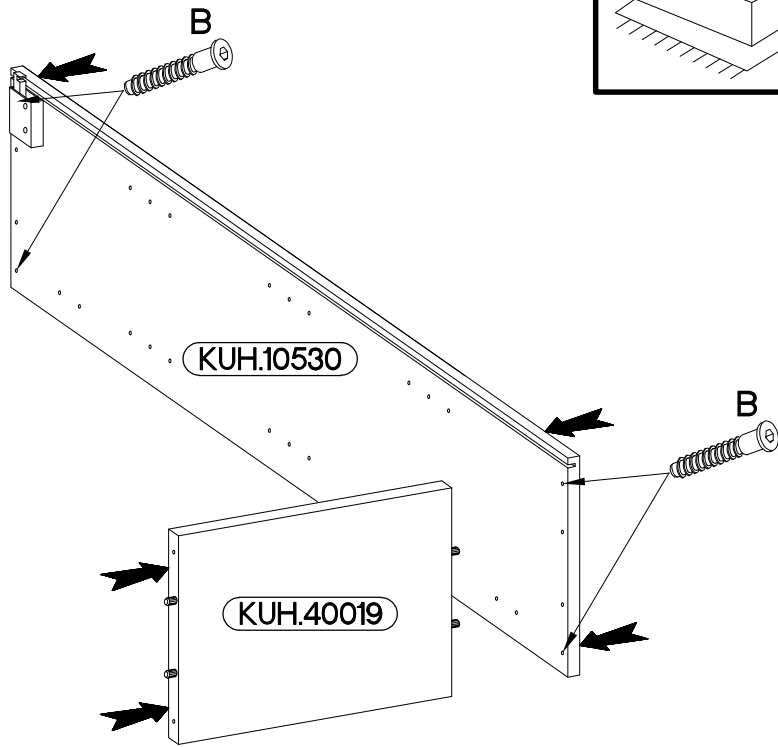
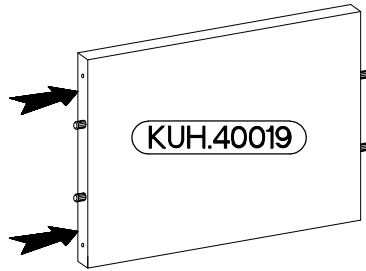
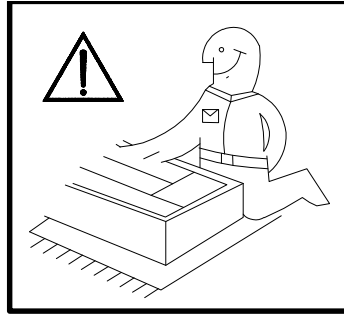
2

6,4 x 50mm		
		
B	O	E1
4	1	4

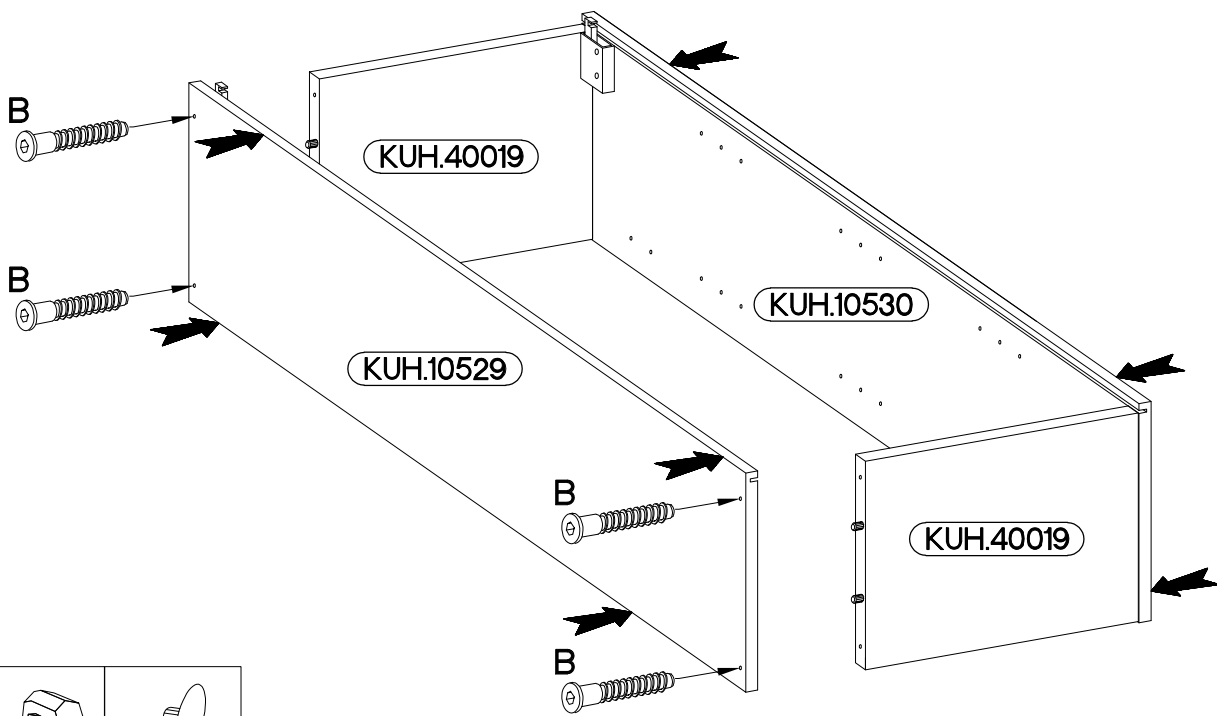

3



6,4 x 50mm		
		
B	O	E1
4	1	4

4

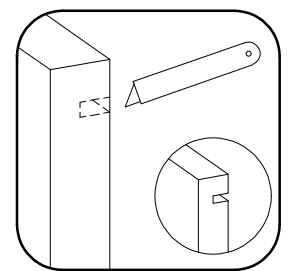
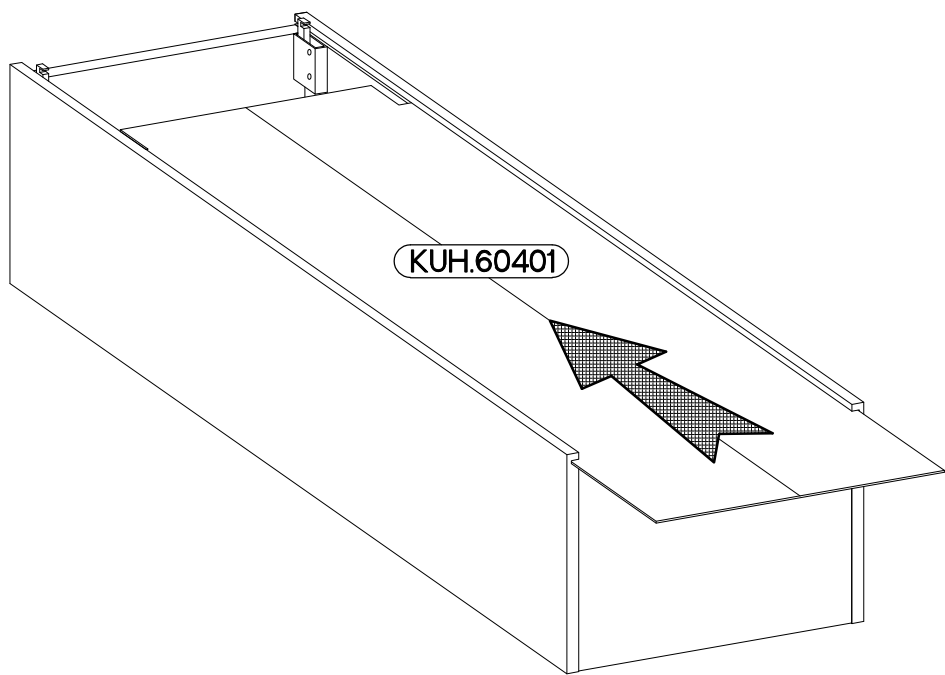
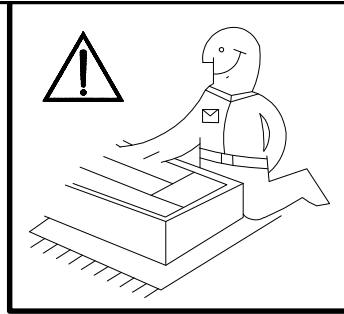

5

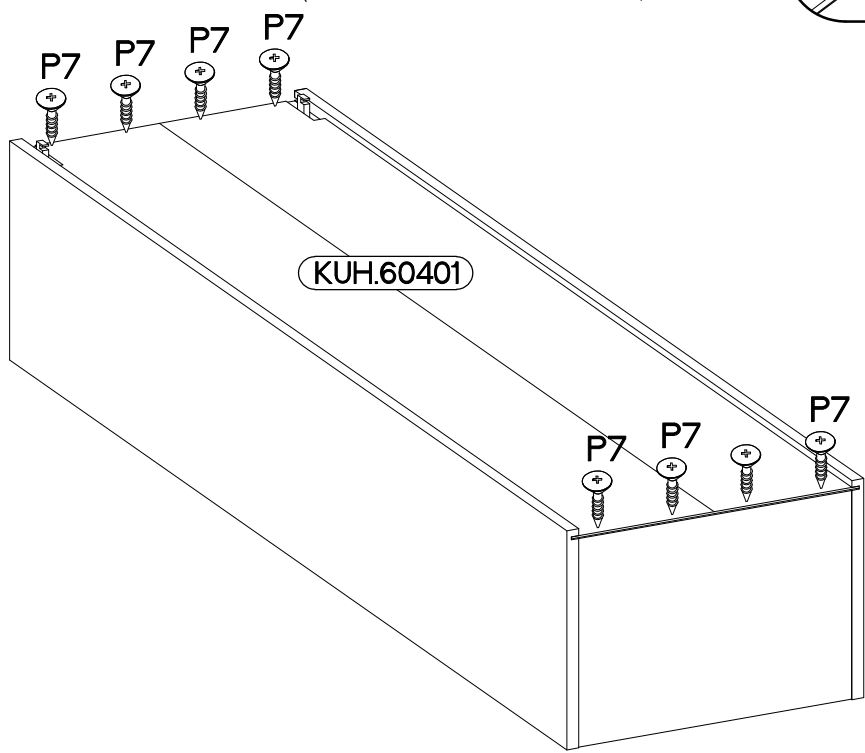
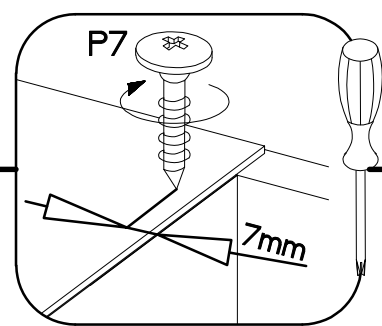
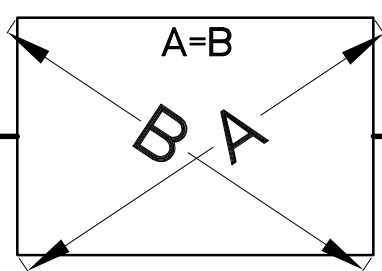
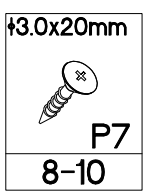

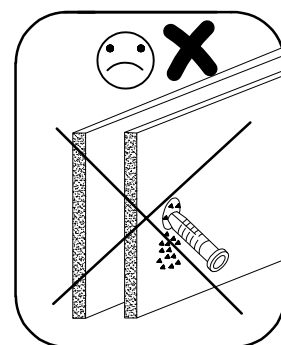
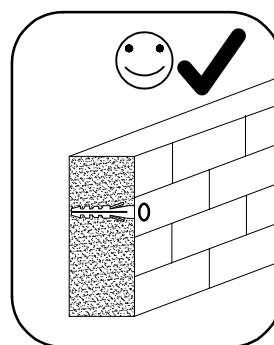
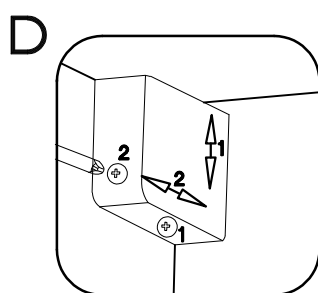
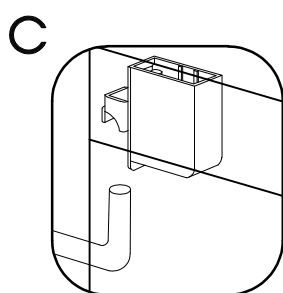
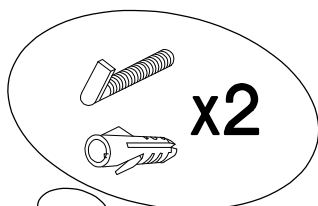
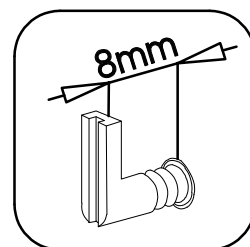
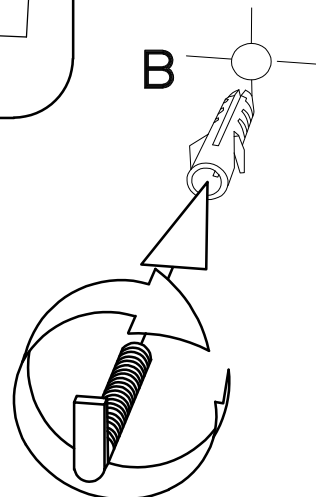
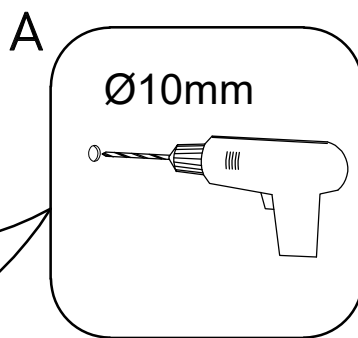
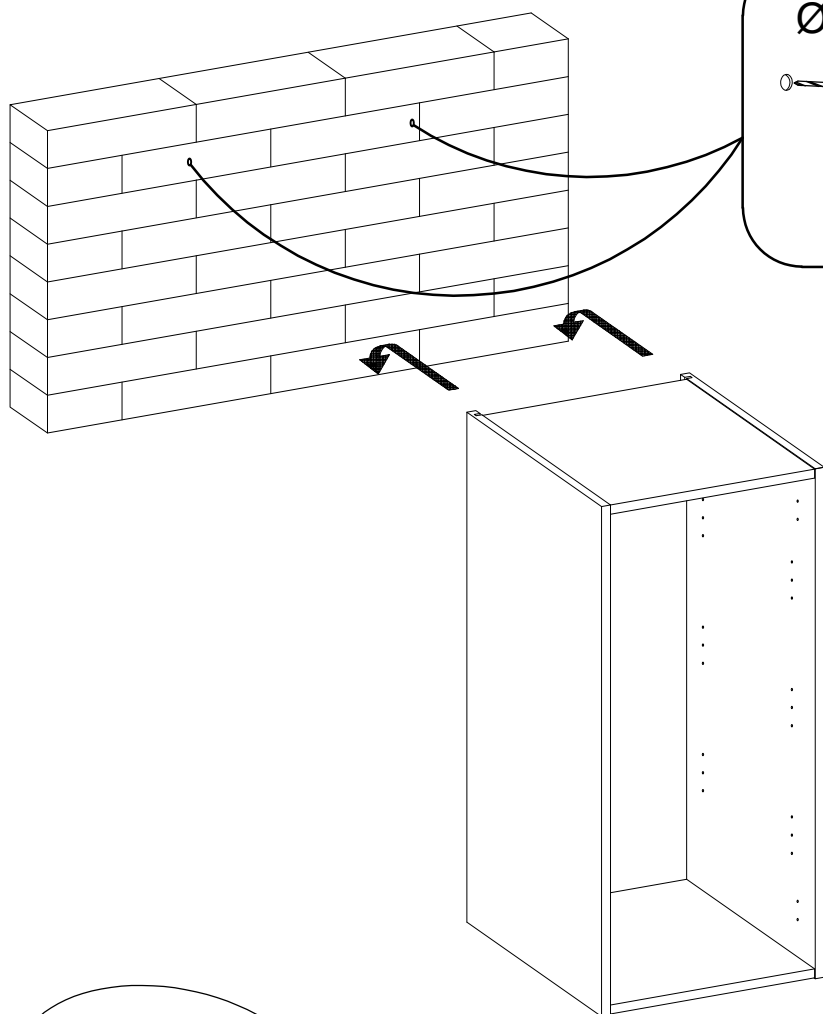
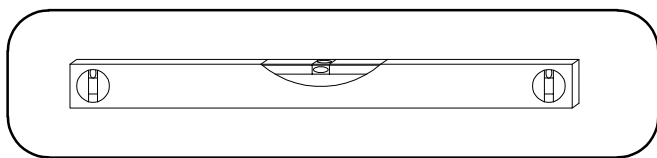

7

±5/19mm
J
12

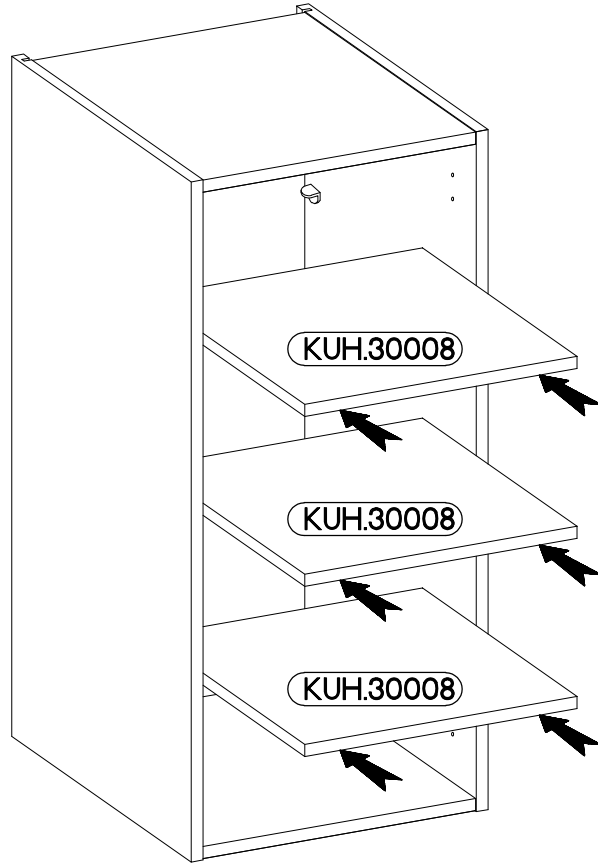
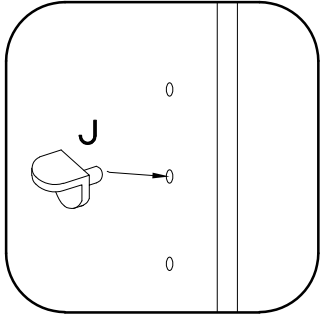

8

FRONT

