

**60 LO-2100**

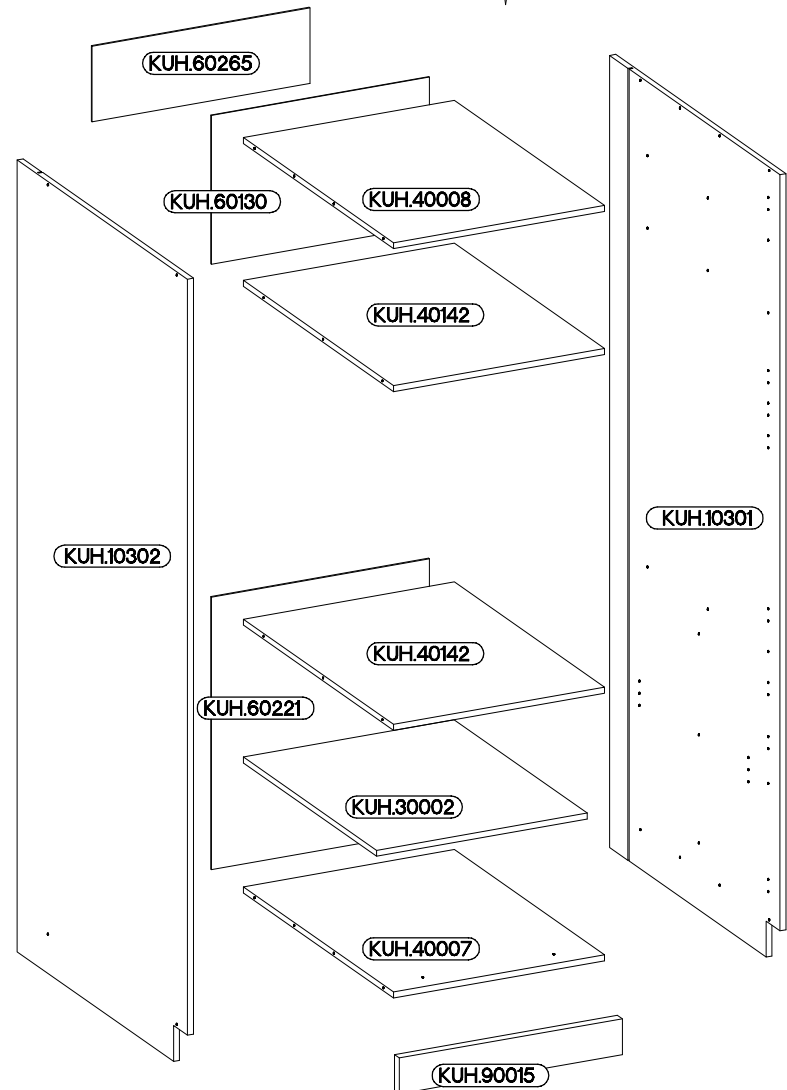

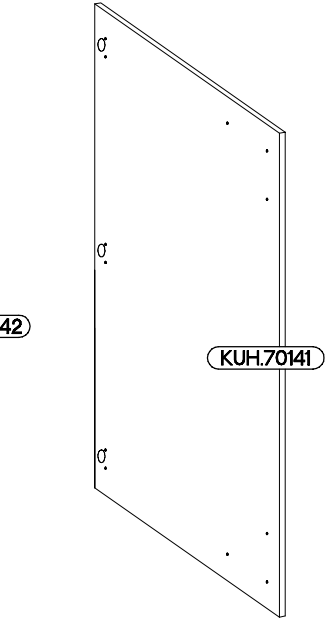

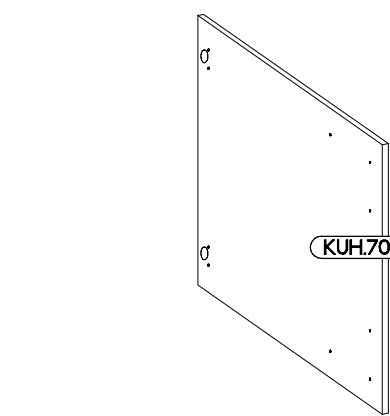
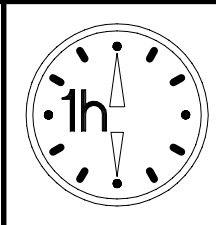
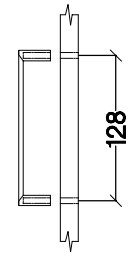
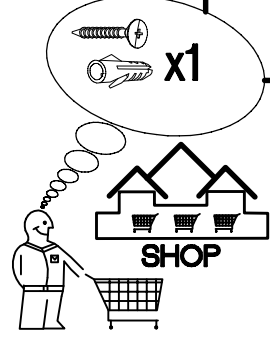
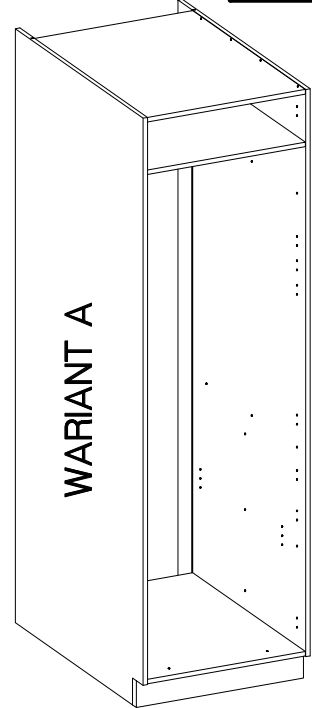
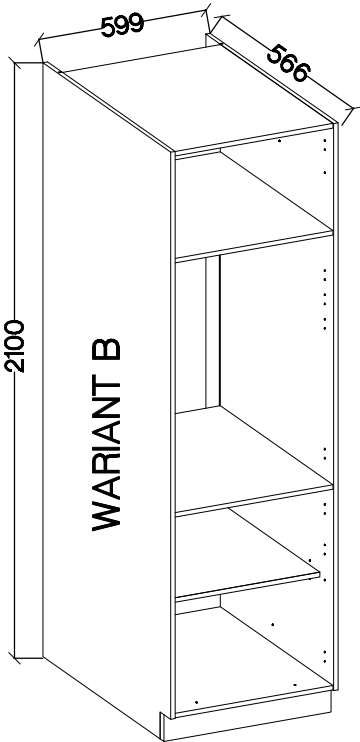
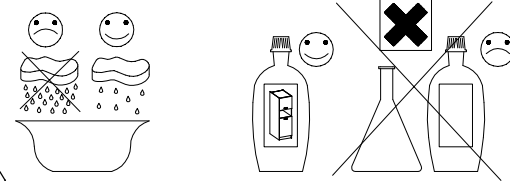
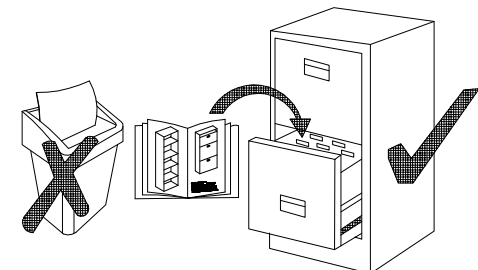

<b>A</b>	<b>B</b>	<b>C</b>	<b>D2</b>	<b>E</b>		
8	8	12	12	12		
<b>E1</b>	<b>E9</b>	<b>F2</b>	<b>HG</b>	<b>J</b>	<b>L25</b>	<b>O</b>
8	2	4	5	4	1	1
<b>P1</b>	<b>P4</b>	<b>P5</b>	<b>P7</b>	<b>S23</b>	<b>T4</b>	<b>U</b>
16	2	12	15-20	2	4	4

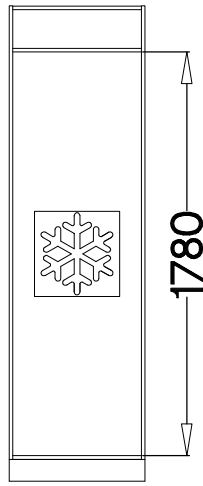
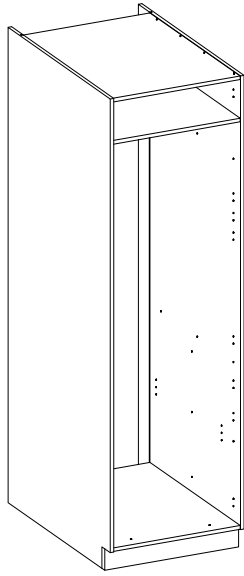

1

# WARIANT A



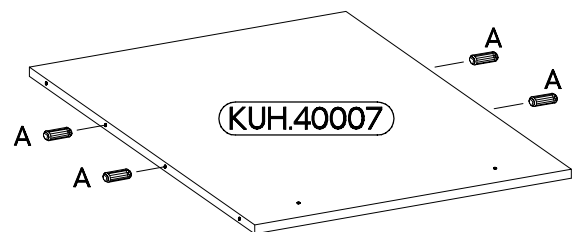
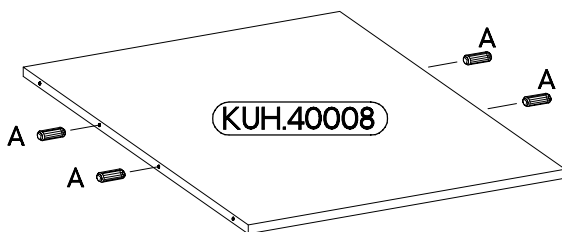
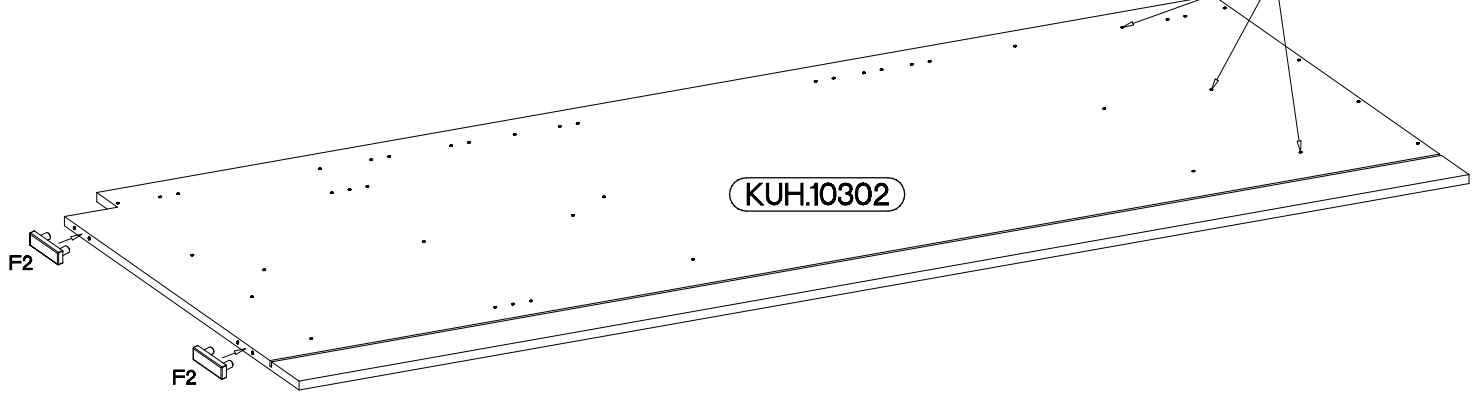
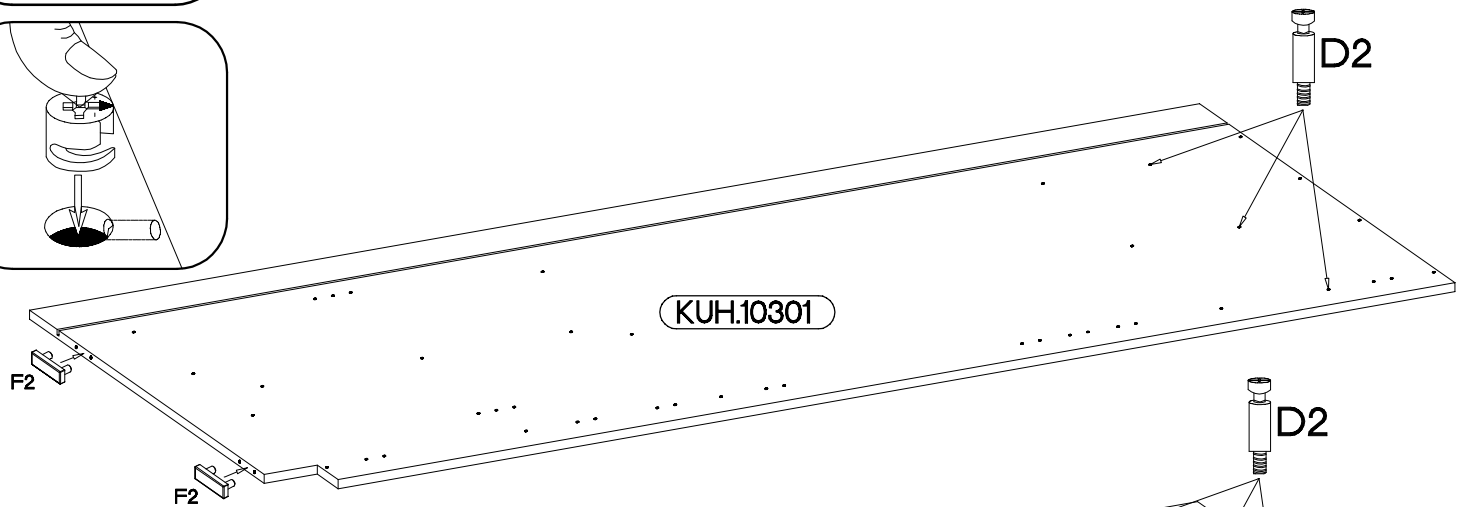
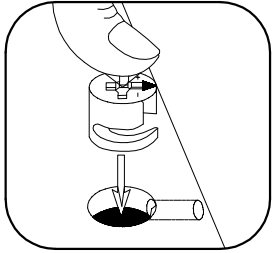
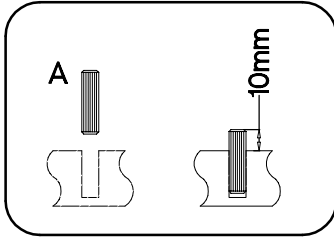
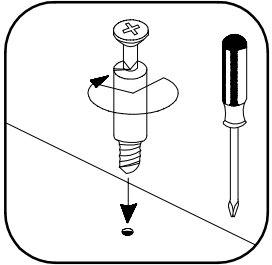
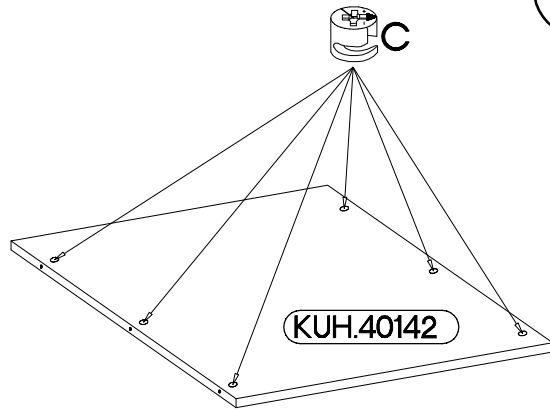
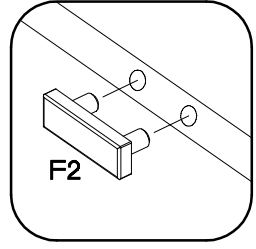
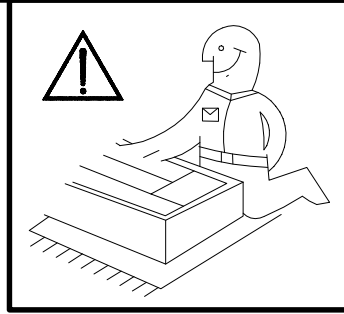

$\varnothing 8 \times 30 \text{mm}$  A	$6.5 \times 48 \times 16$  F2
8 L=20mm  D2	4 $\varnothing 15 / 12 \text{mm}$  C
6	6



2

6,4 x 50mm

		
B	O	E1
4	1	4

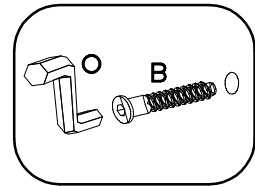
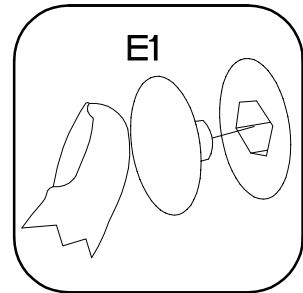
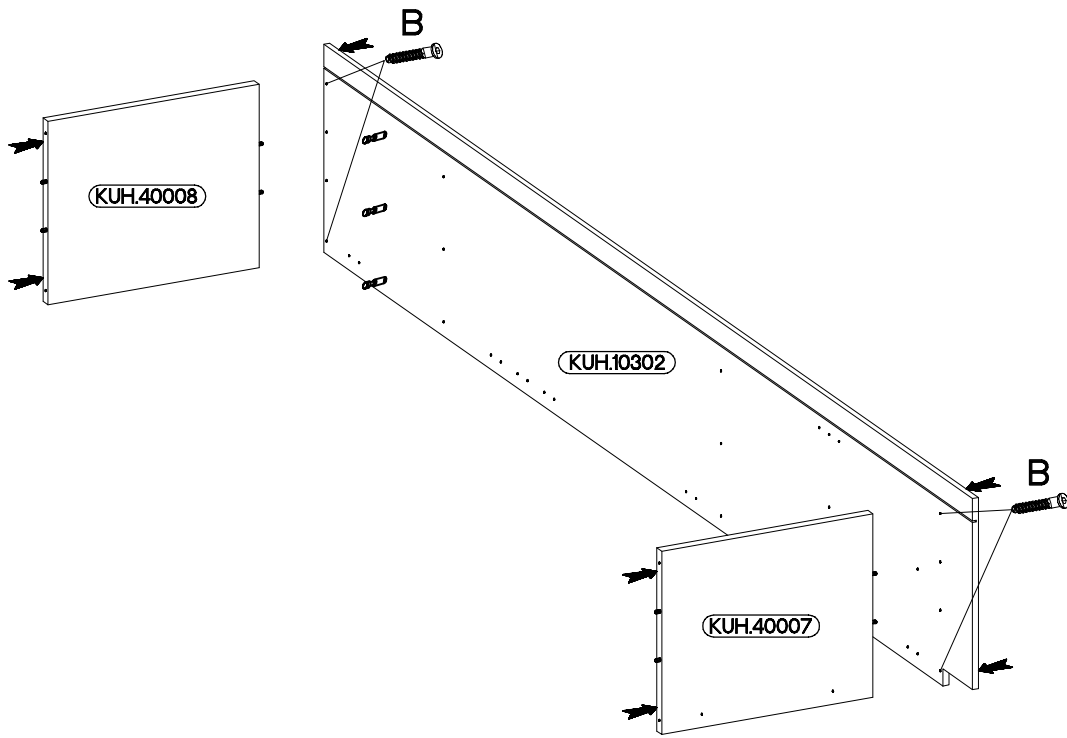
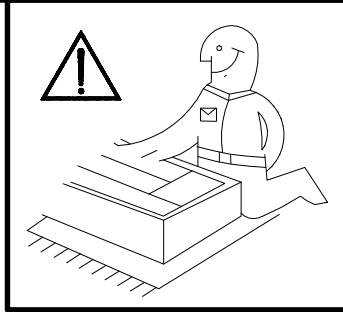

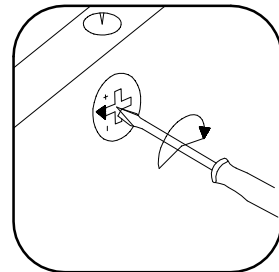
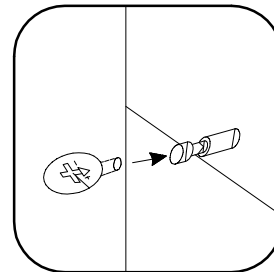
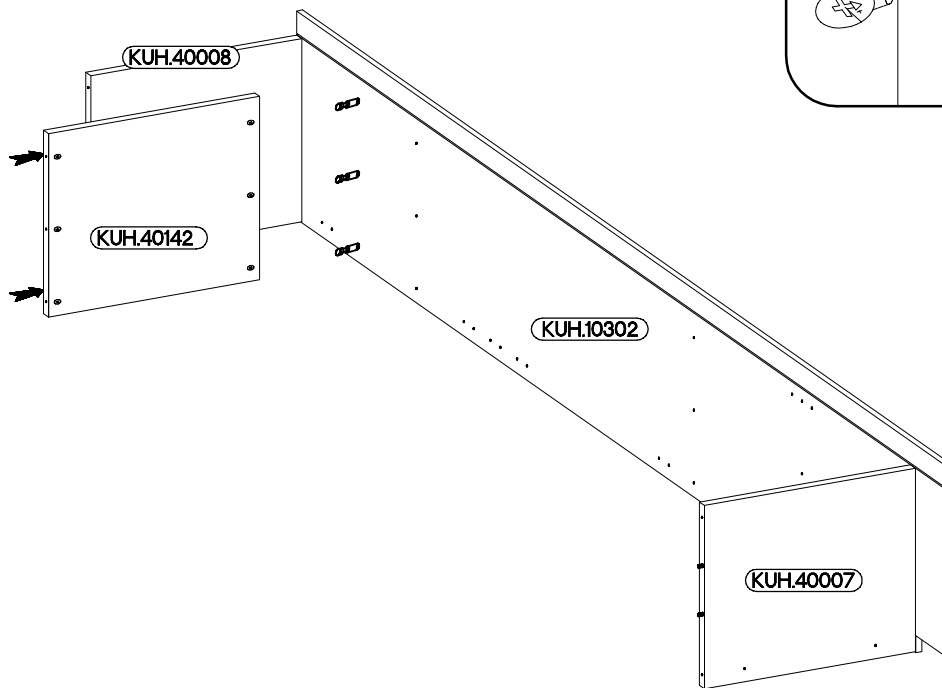

3



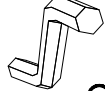

# 4

6,4 x 50mm

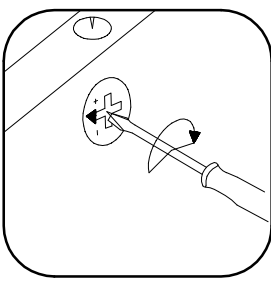
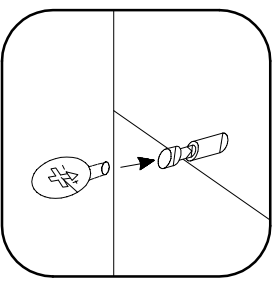
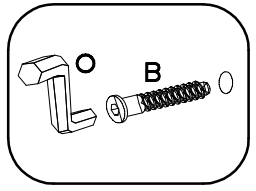
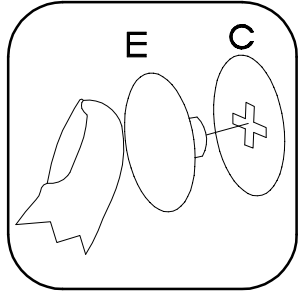
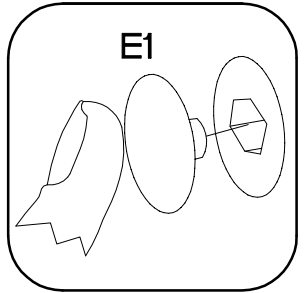
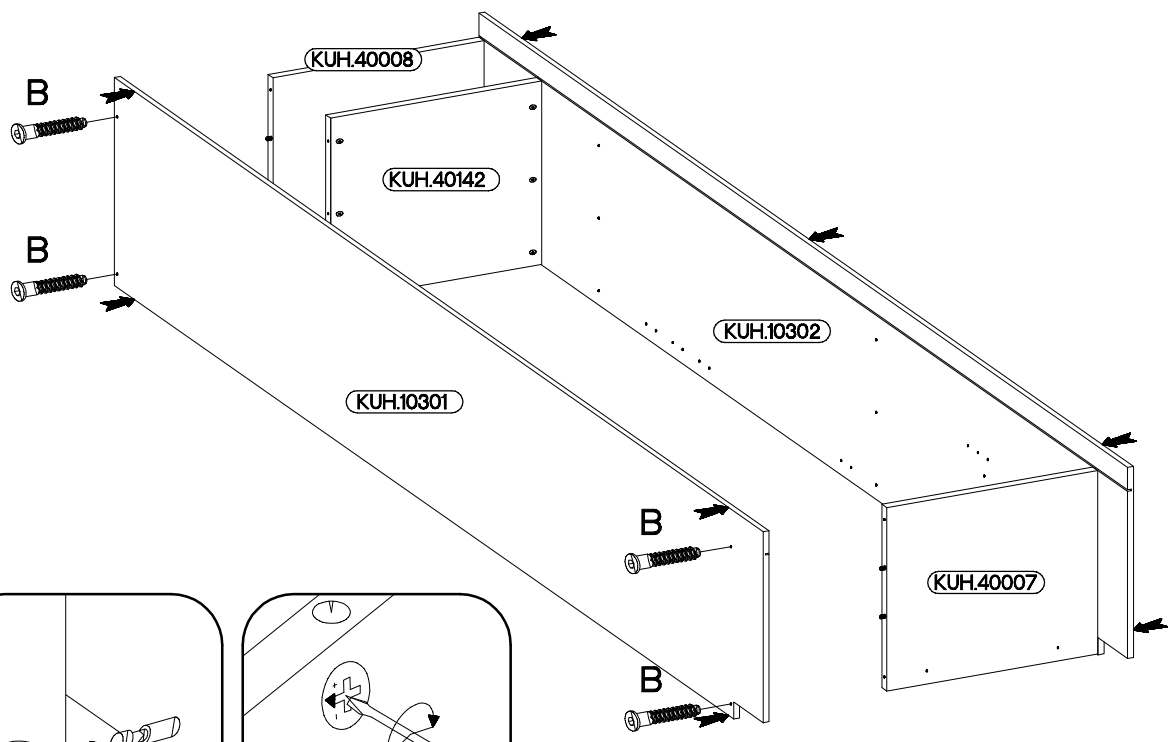
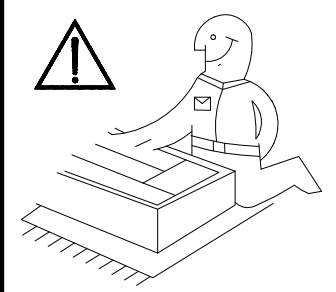
			
<b>B</b>	<b>O</b>	<b>E1</b>	<b>E</b>
4	1	4	6

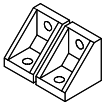

# 5

	
<b>T4</b>	<b>P1</b>
4	16

±4.0x16mm

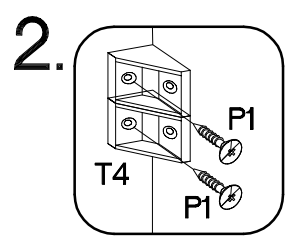
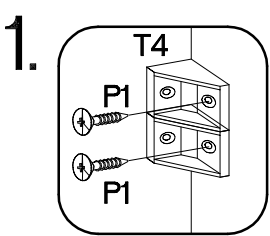
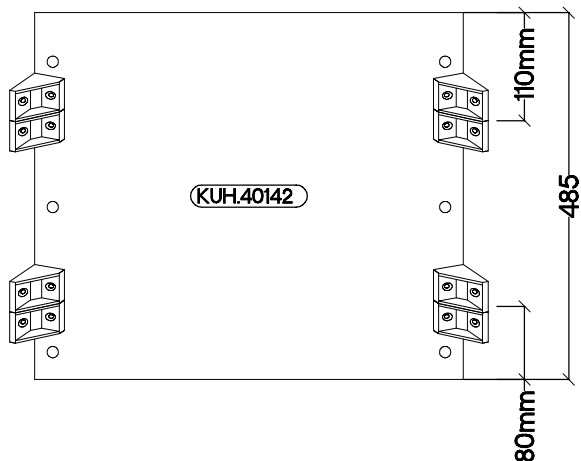
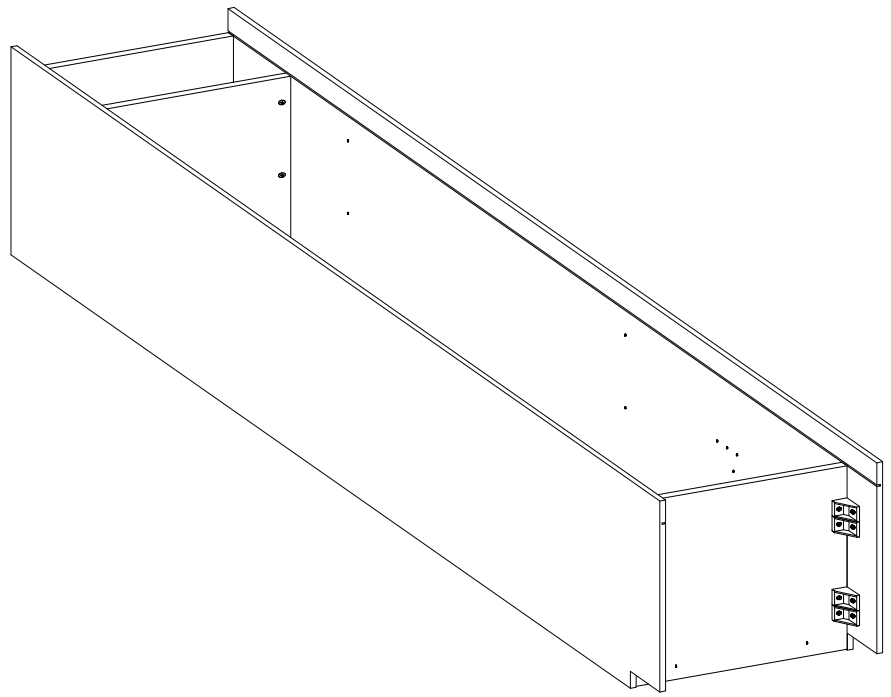

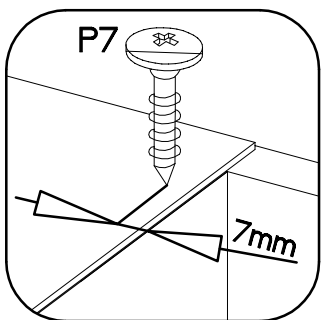
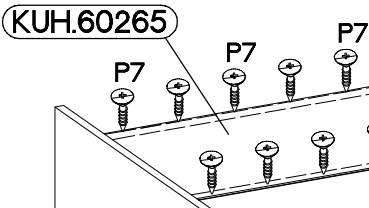
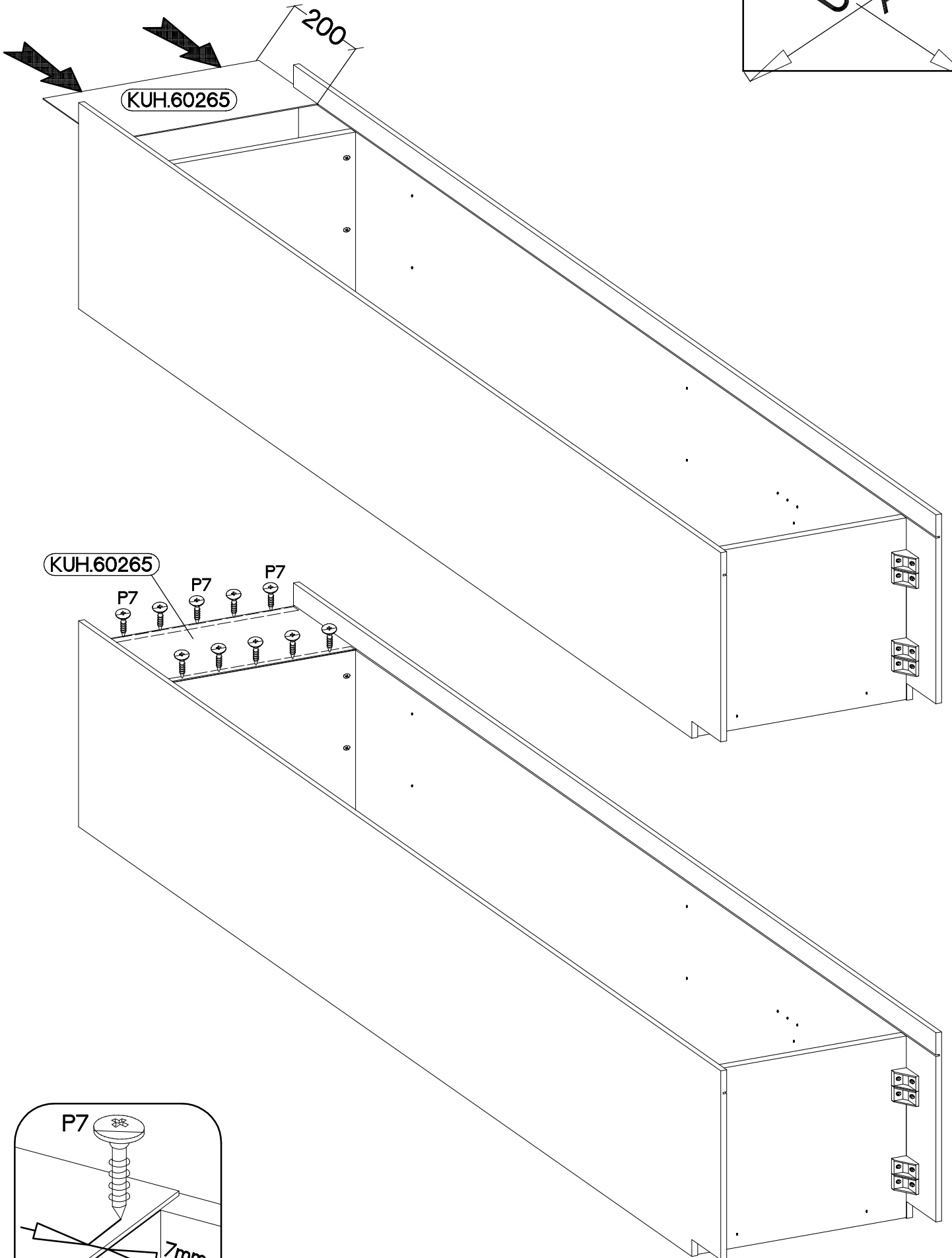
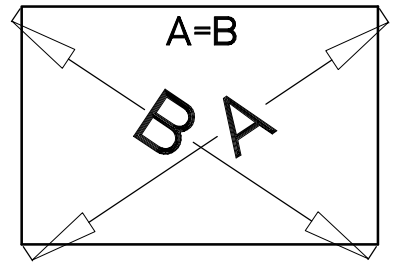

6

±3.0x20mm  
P7  
8-10



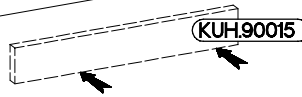
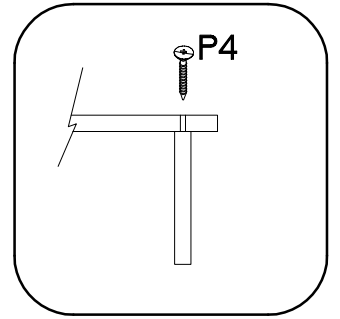
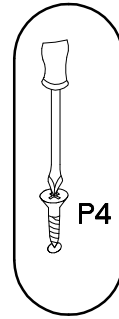
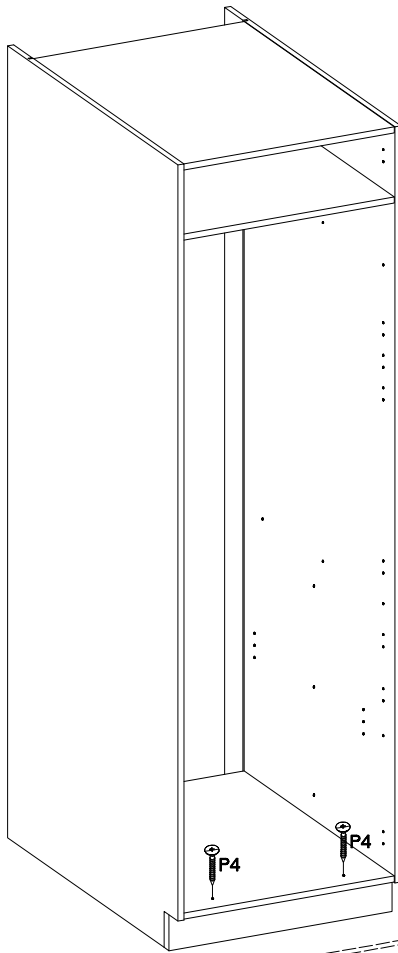

7

 †4.0x45mm P4 2	 E9 2
--	---

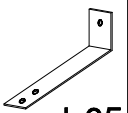

8

 L25 1	 †3.5x13mm P5 2
---	---

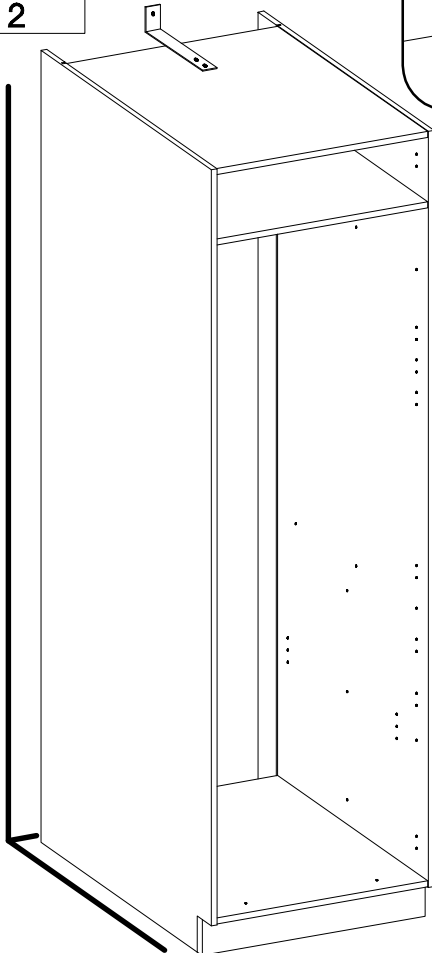

1.

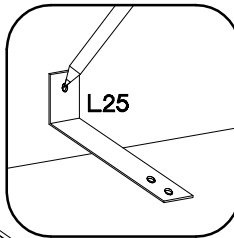

2.

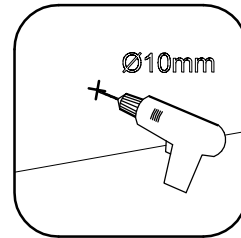

3.

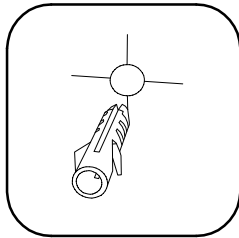

4.

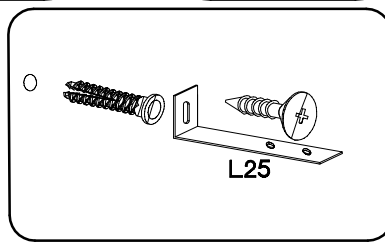

5.

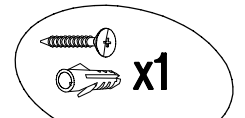
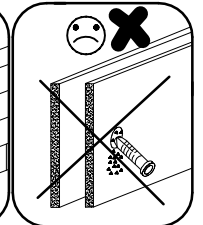
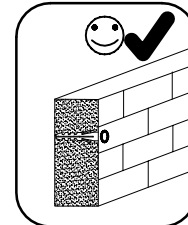
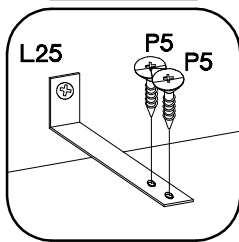

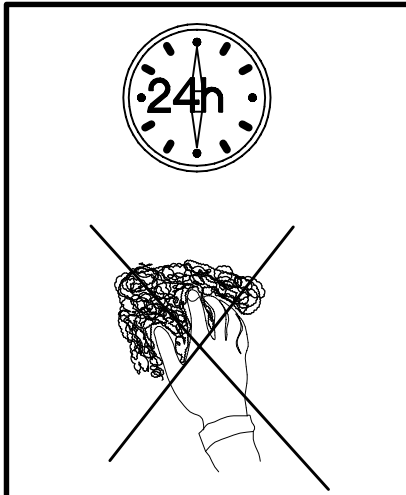
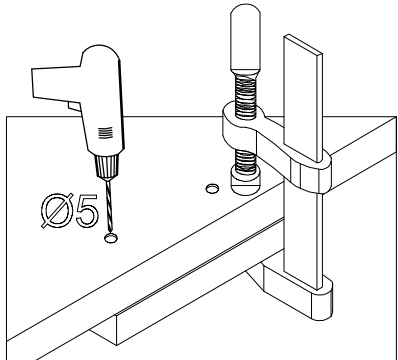
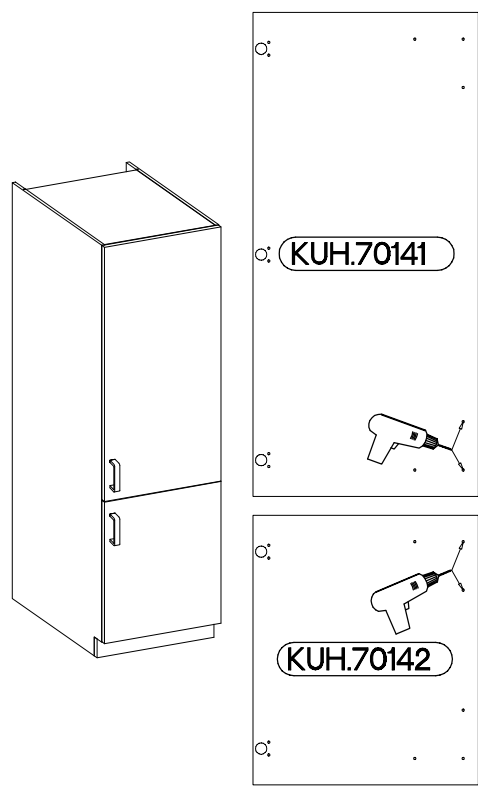
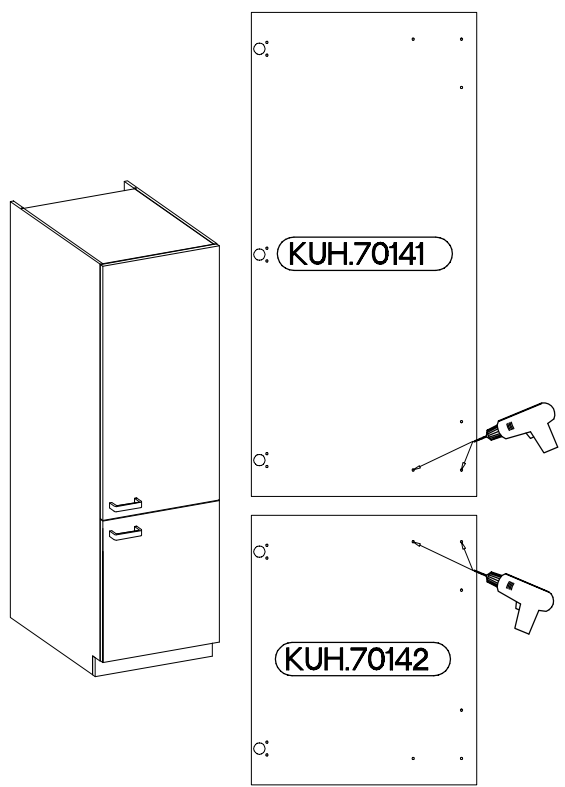
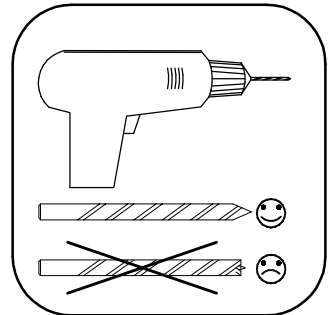
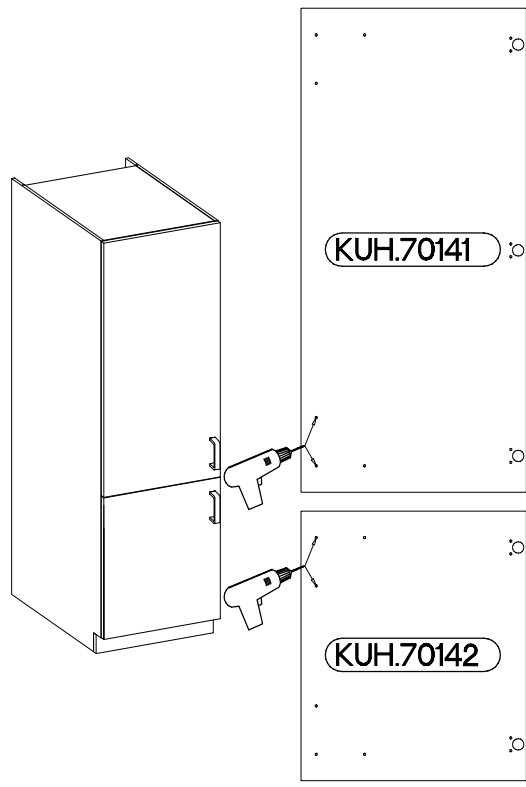
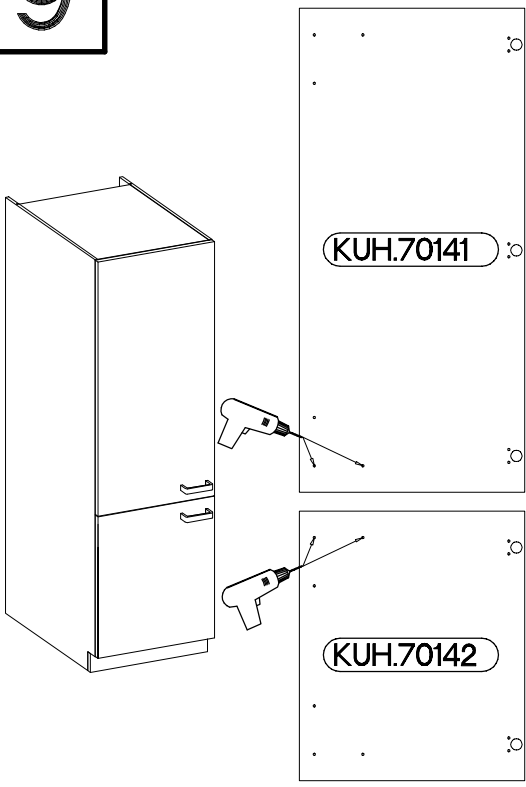

VARIANT HIGH GLOSS

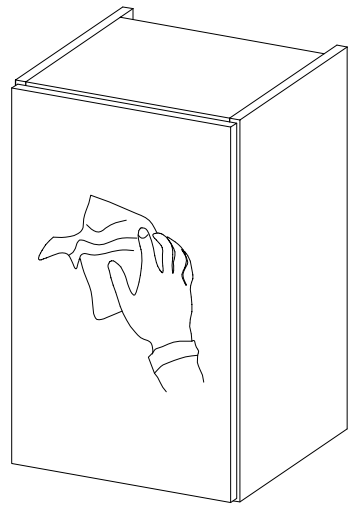
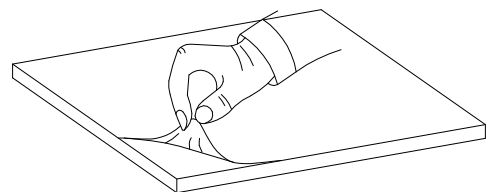
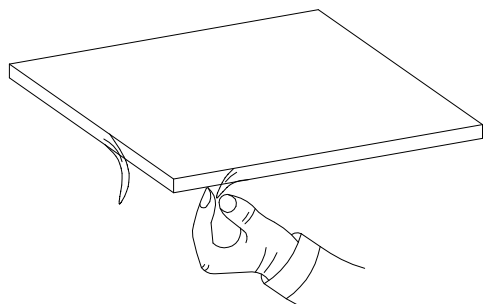

# 10

∅35/0mm	∅3.5x13mm
HG	P5
5	10

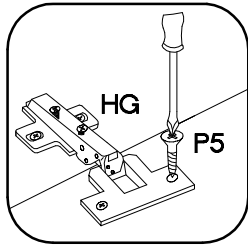
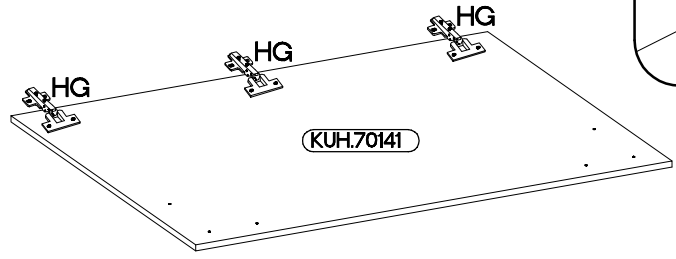
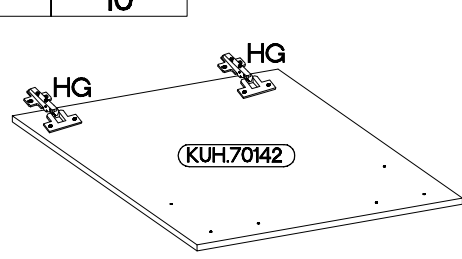

# 11



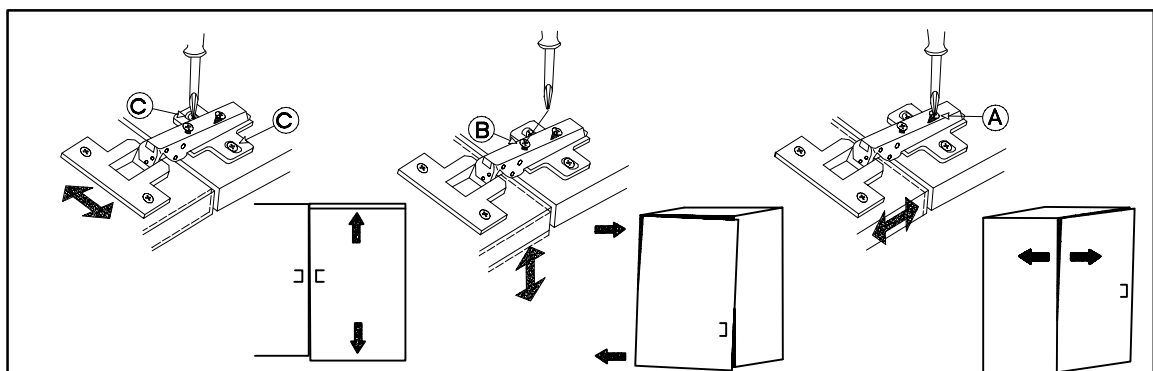
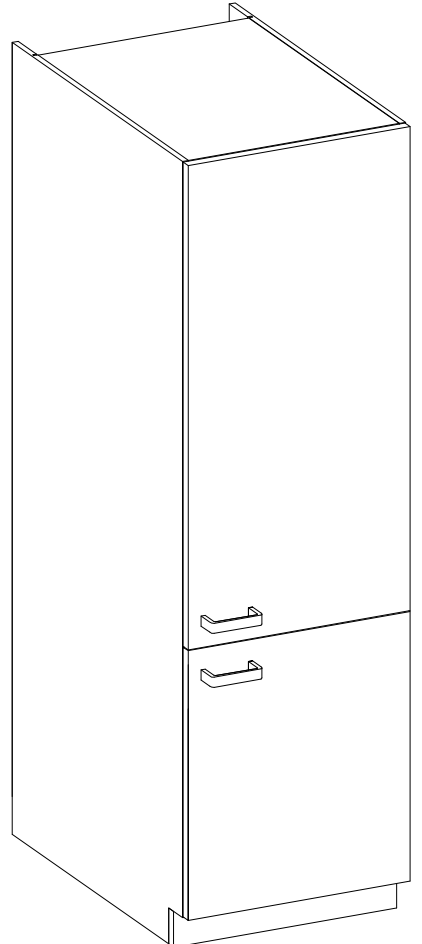
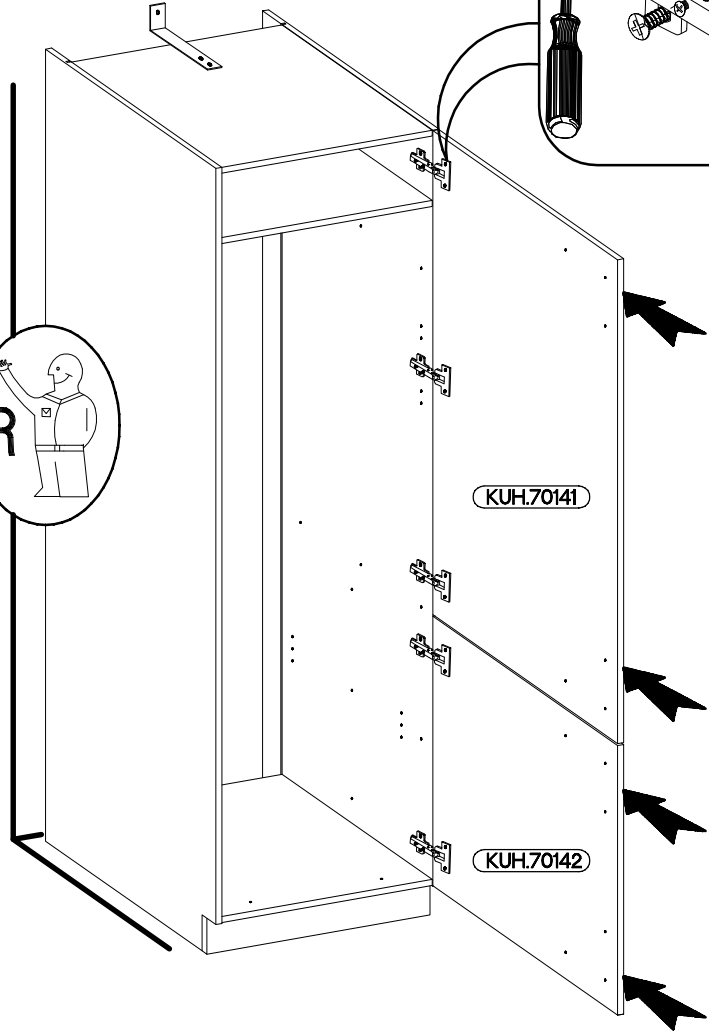
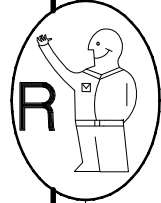
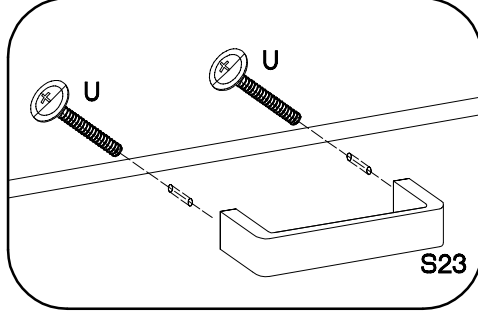
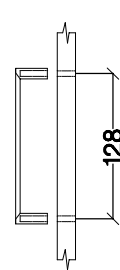
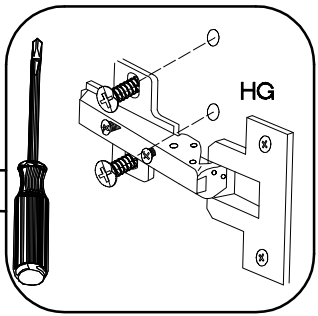

M4x22mm	
	S23
4	2



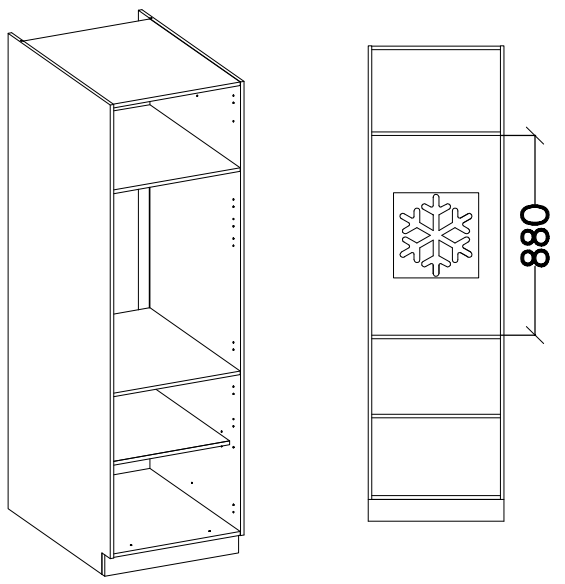

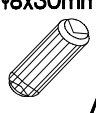
## WARIANT B



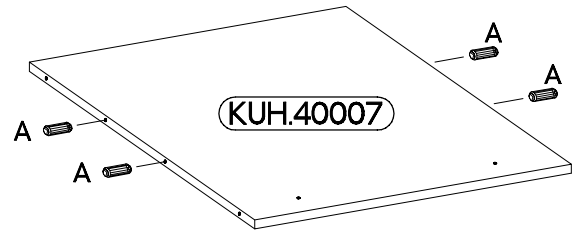
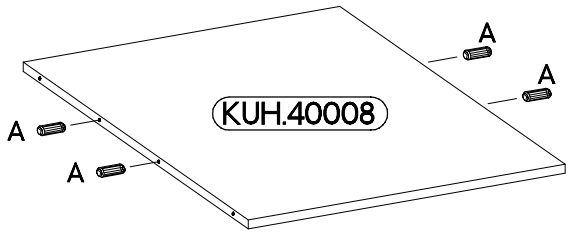
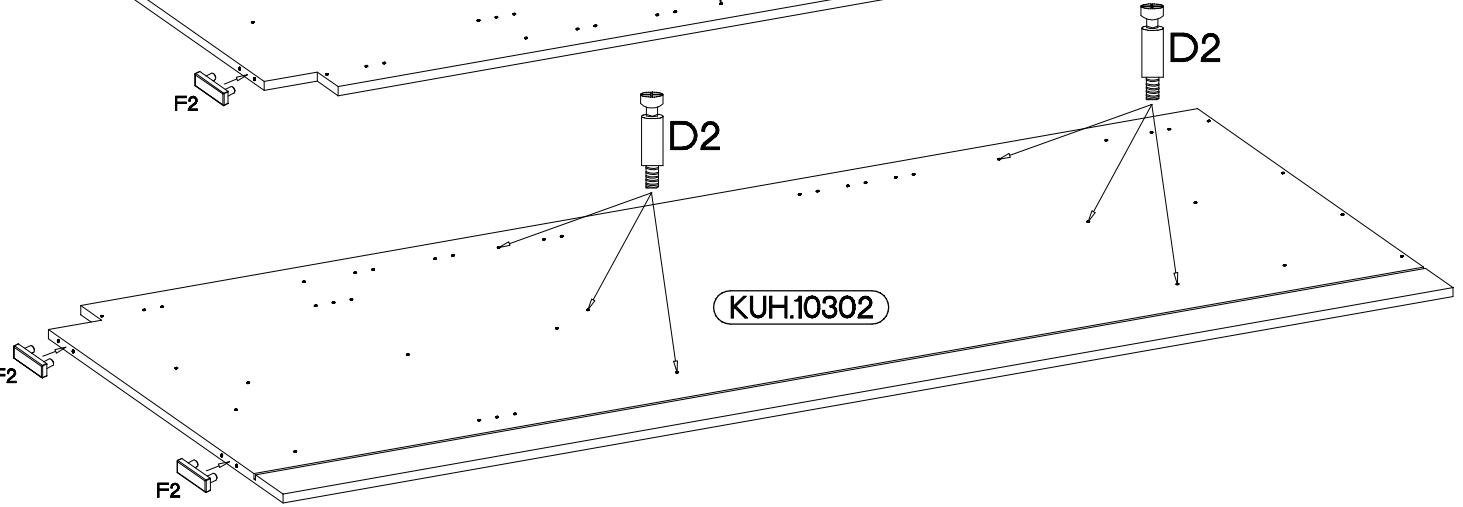
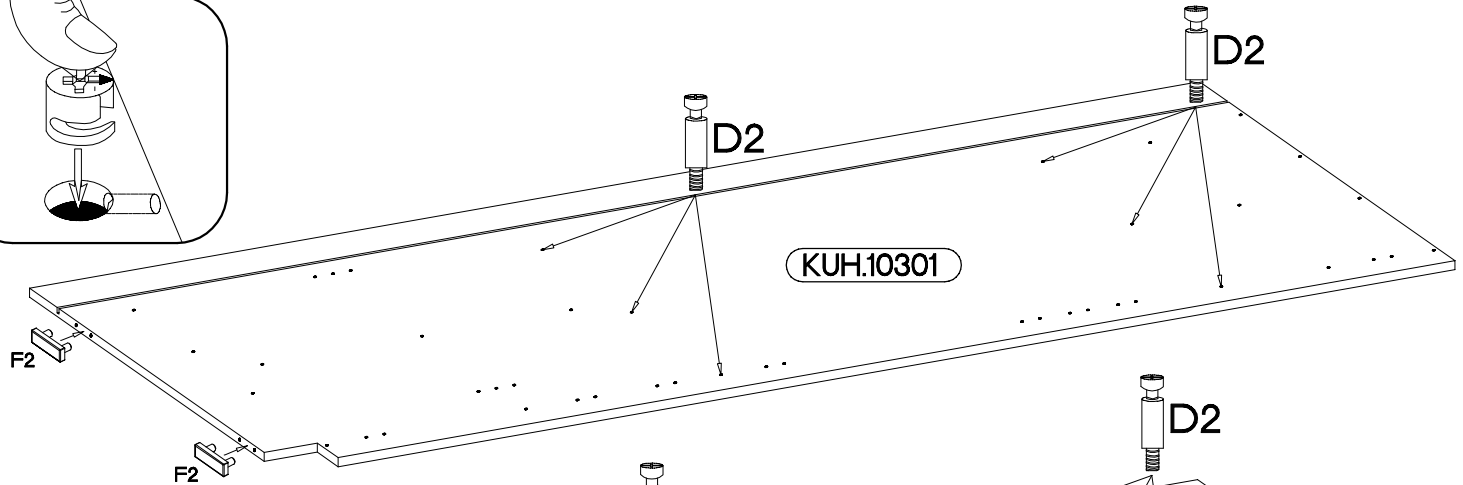
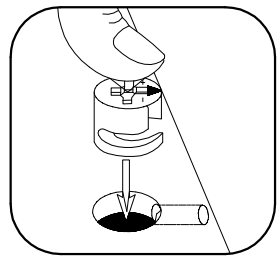
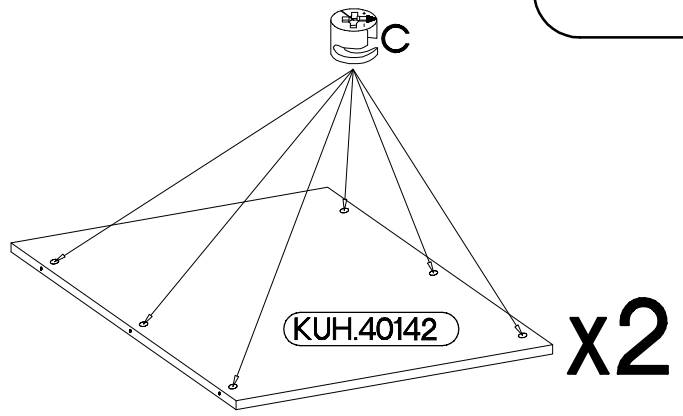
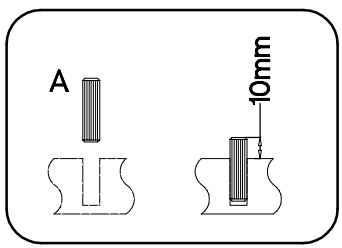
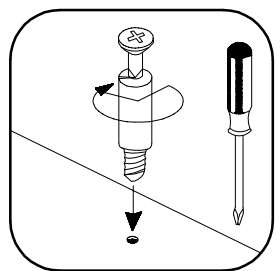
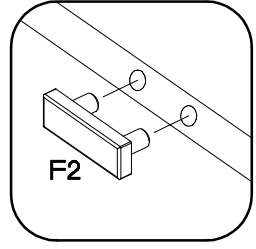
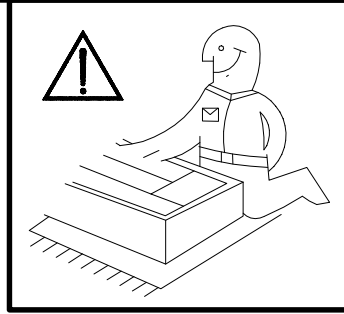

 A	 F2
8 L=20mm	4 ∅15/12mm
 D2	 C
12	12



# 13

6,4 x 50mm

		
<b>B</b>	<b>O</b>	<b>E1</b>
4	1	4

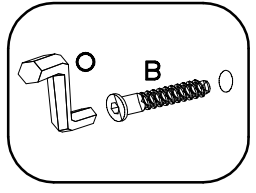
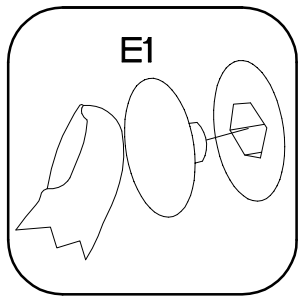
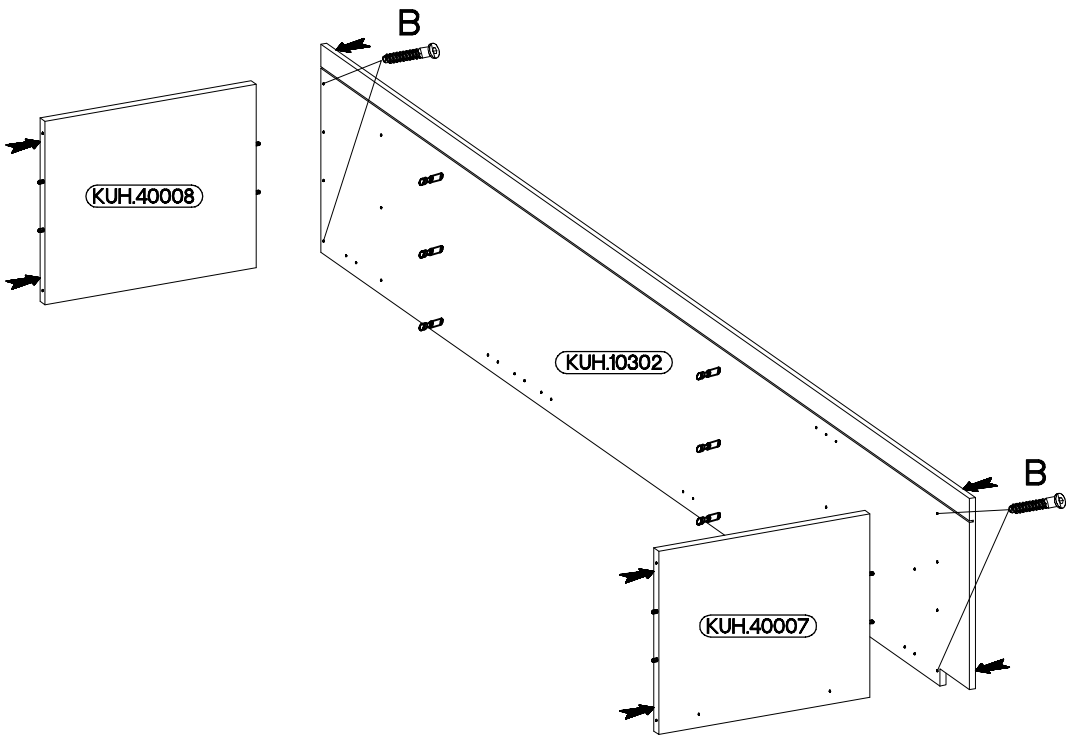
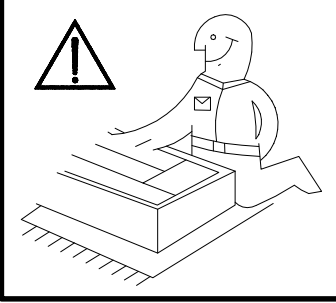



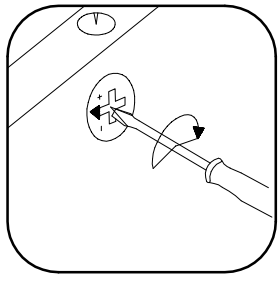
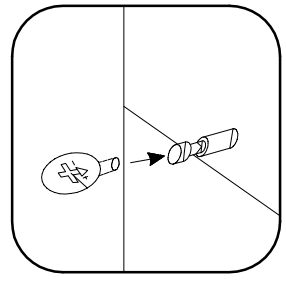
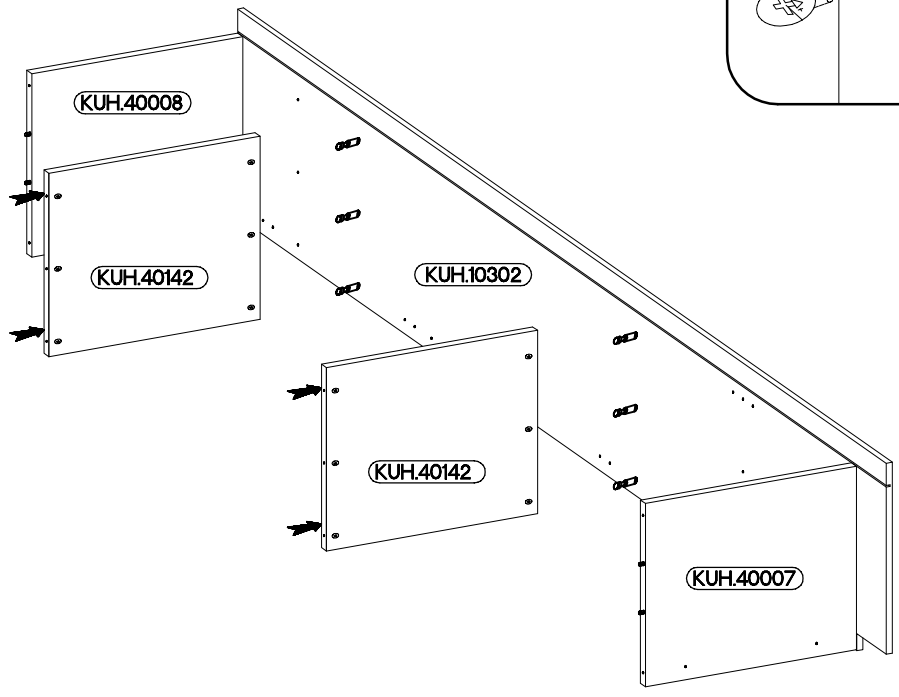

# 14





# 15

6,4 x 50mm

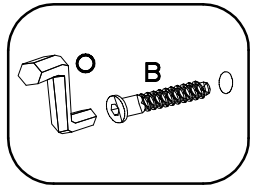
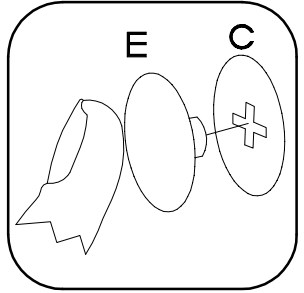
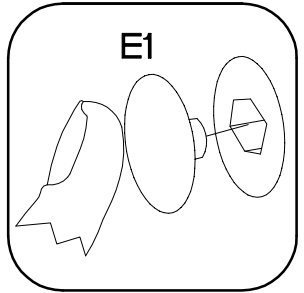
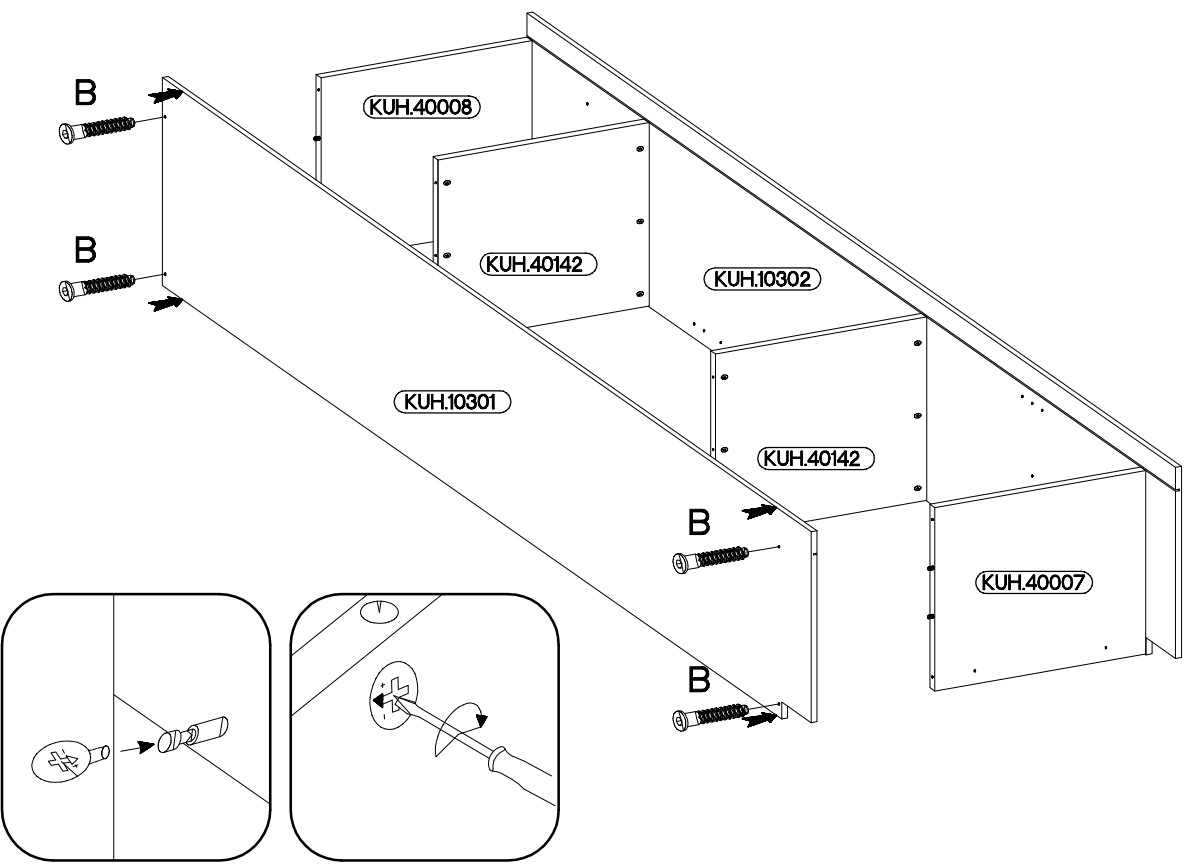
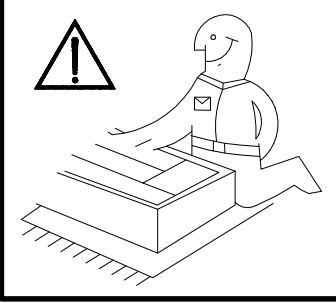
			
<b>B</b>	<b>O</b>	<b>E1</b>	<b>E</b>
4	1	4	12

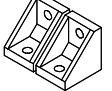

# 16

	
<b>T4</b>	<b>P1</b>
4	16

4.0x16mm

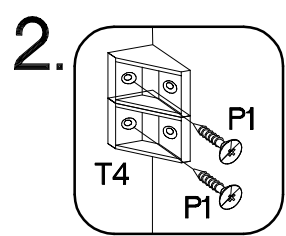
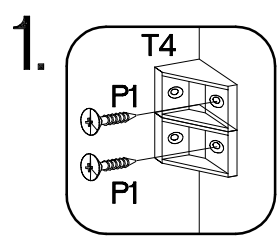
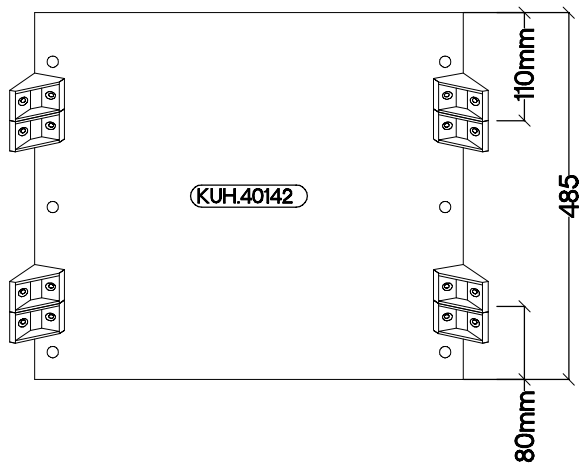
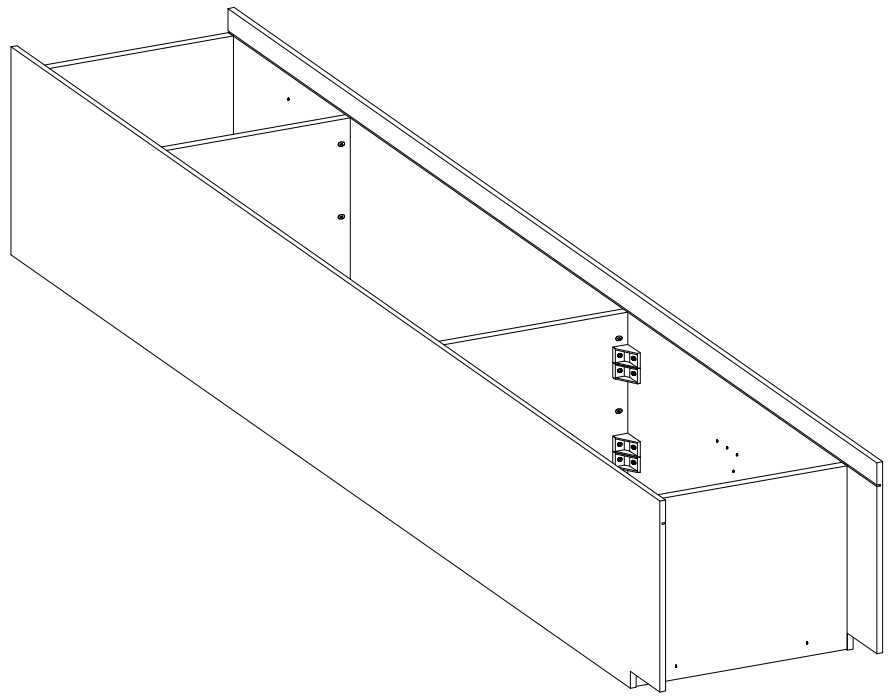

±3.0x20mm  
P7  
15-20

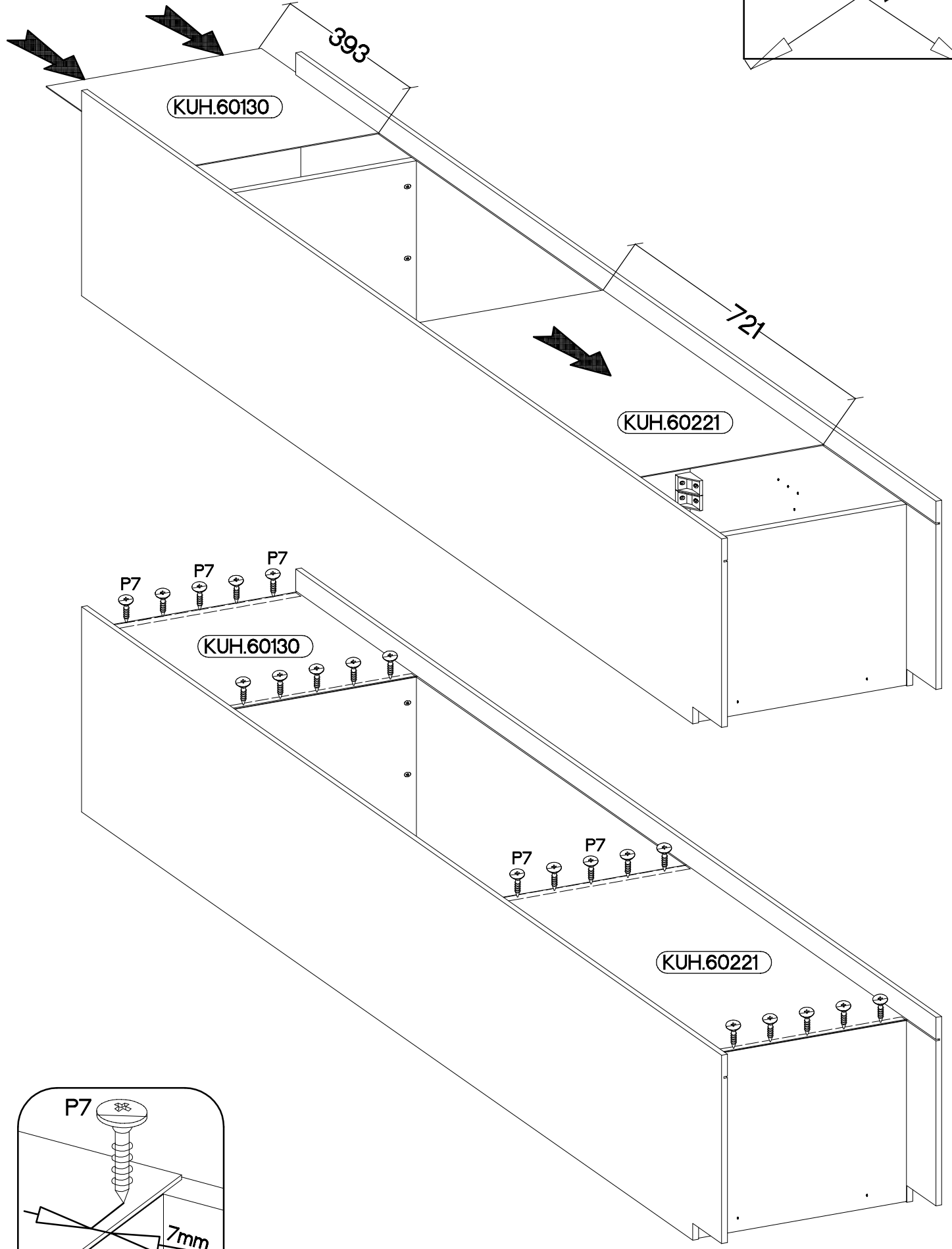
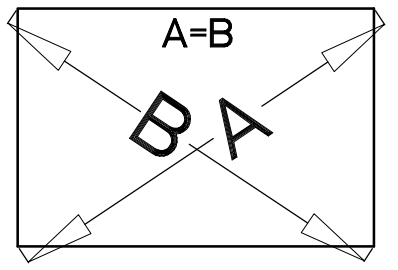

P7 P7 P7

KUH.60130

P7 P7

KUH.60221

P7 P7 P7 P7

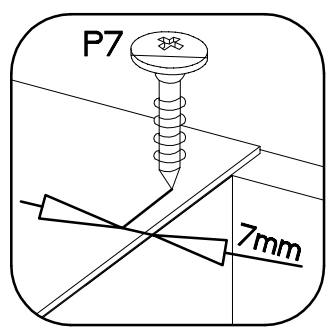

# 18

±4.0x45mm



P4

2



E9

2

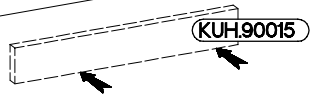
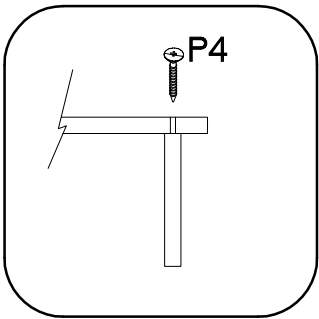
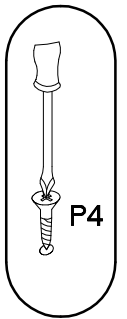
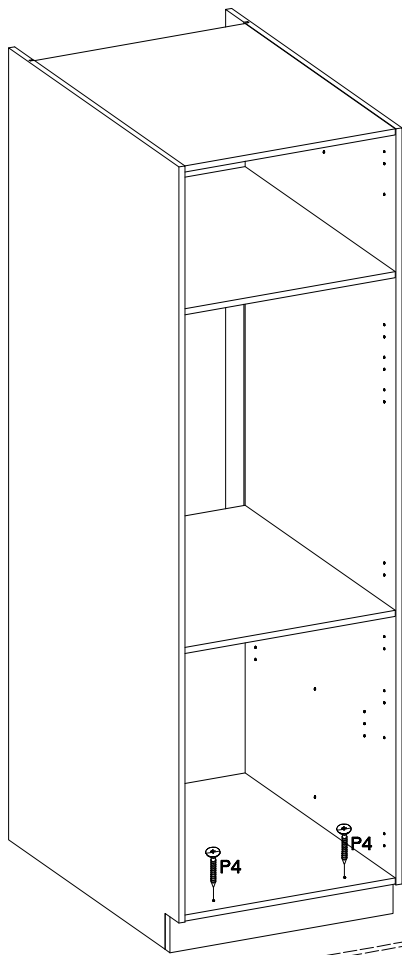

# 19

±5/19mm



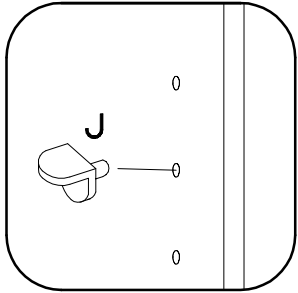
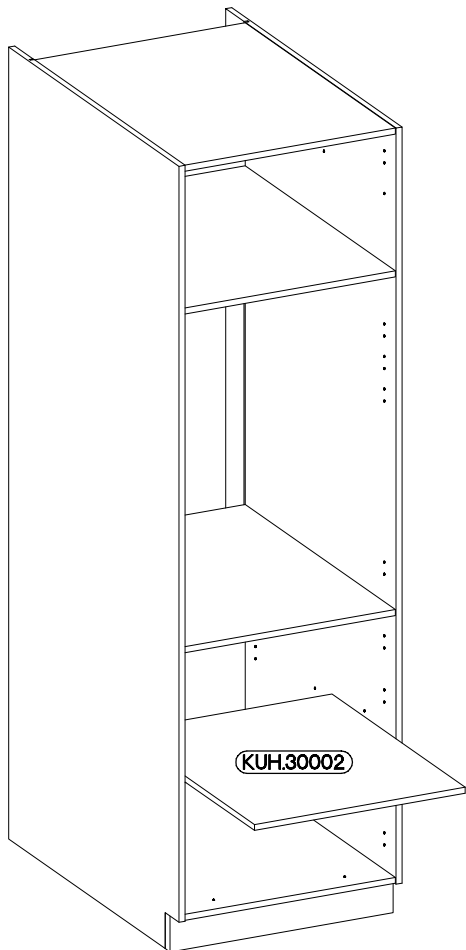

J

4

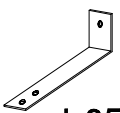

(KUH.30002)

	$\pm 3.5 \times 13 \text{mm}$ 
L25	P5
1	2

1.

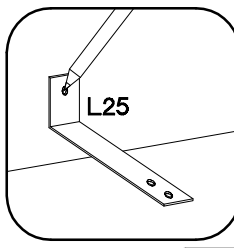

2.

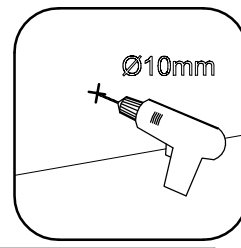

3.

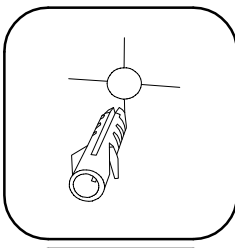

4.

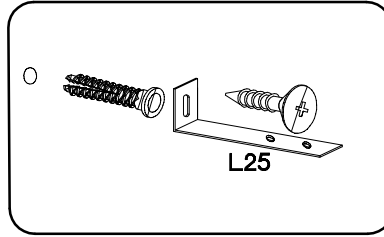

5.

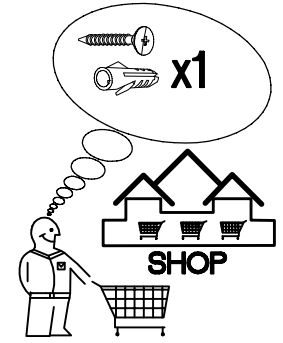
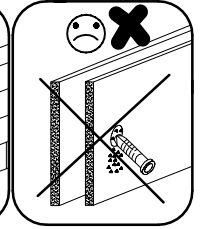
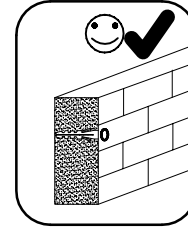
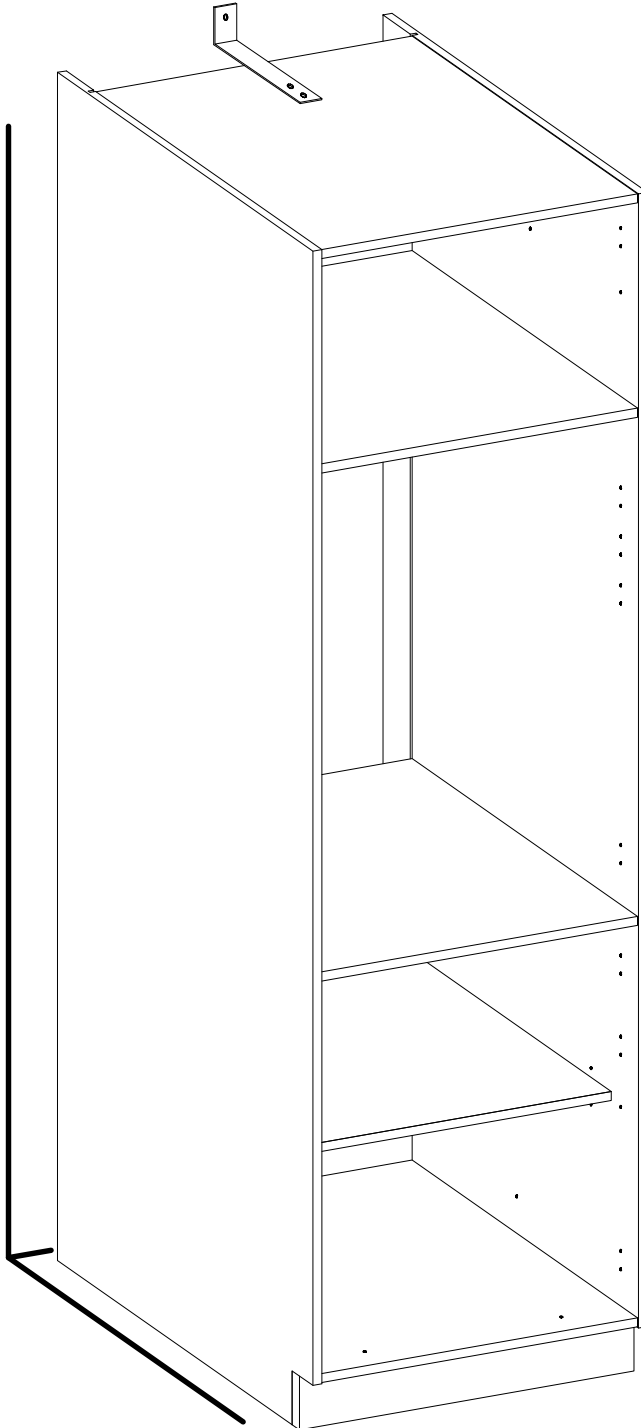
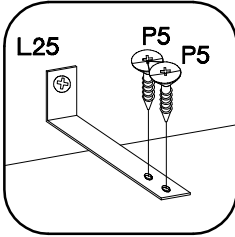

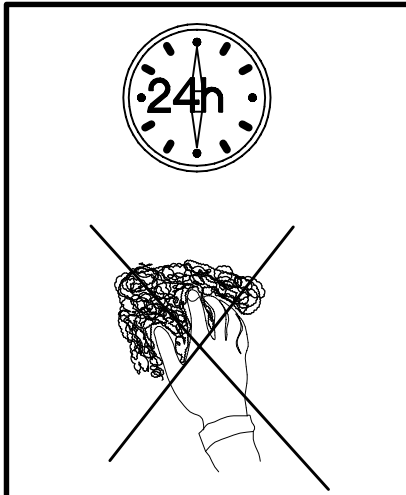
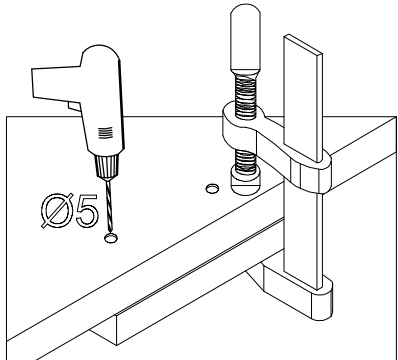
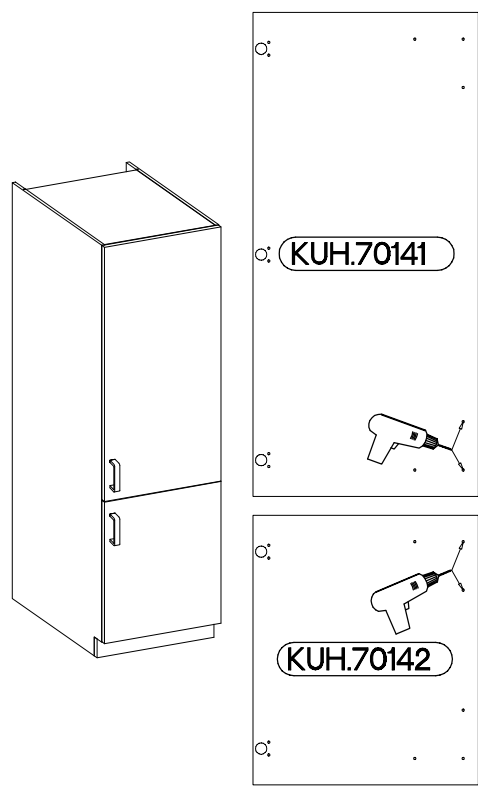
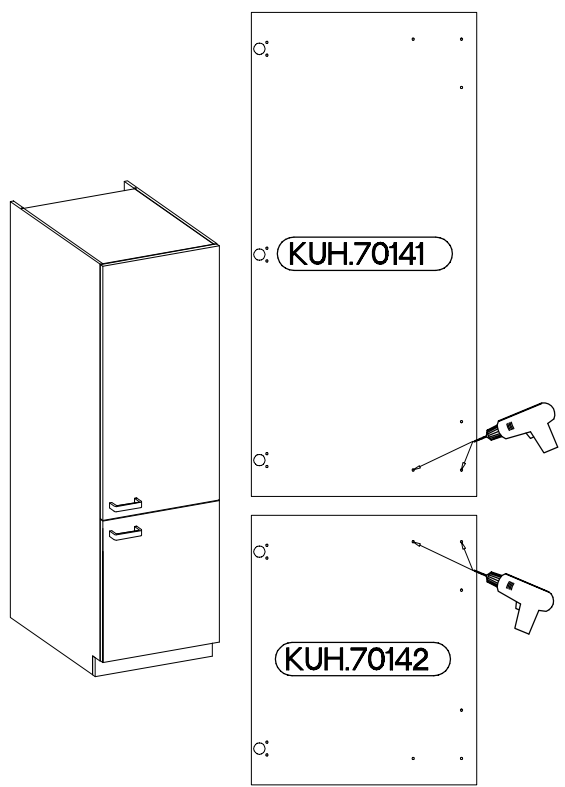
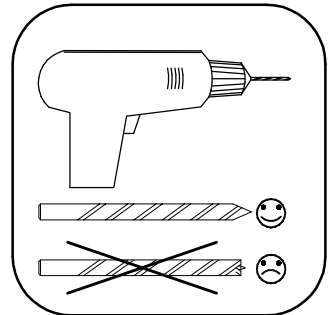
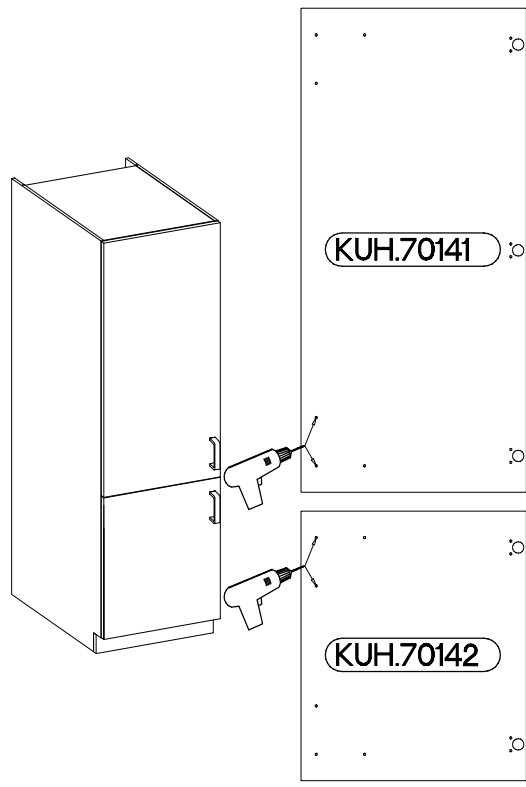
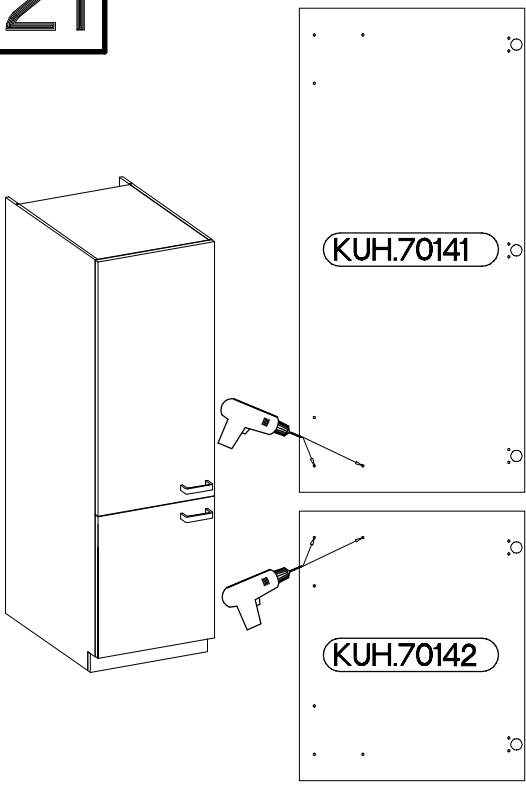

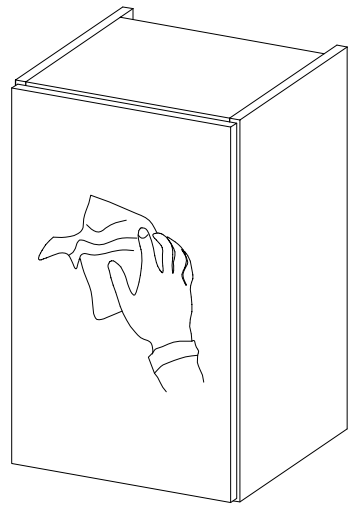
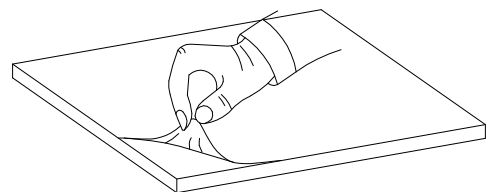
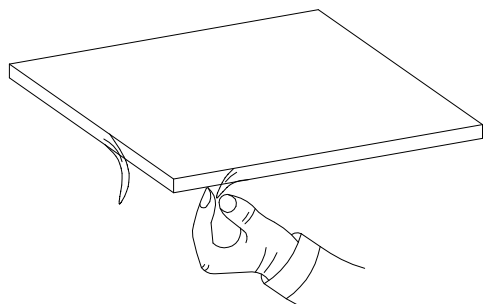

VARIANT HIGH GLOSS



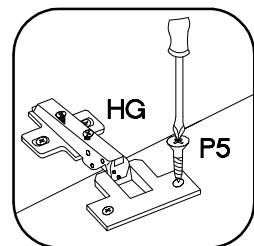
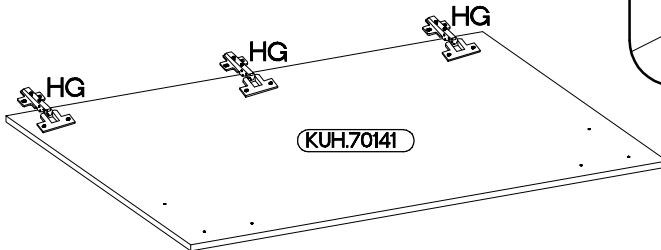
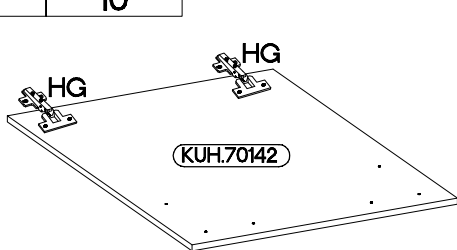

# 22

±35/0mm	±3.5x13mm
	
HG	P5
5	10



# 23

M4x22mm	
	S23
4	2

