

60 DK-2100

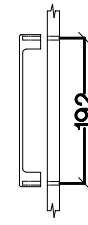

max. 5kg
 KUH.30002
 KUH.40007
 KUH.40008

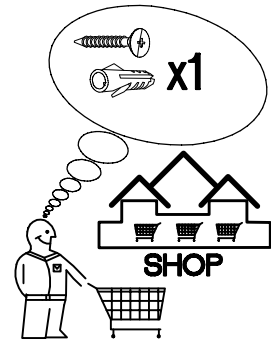

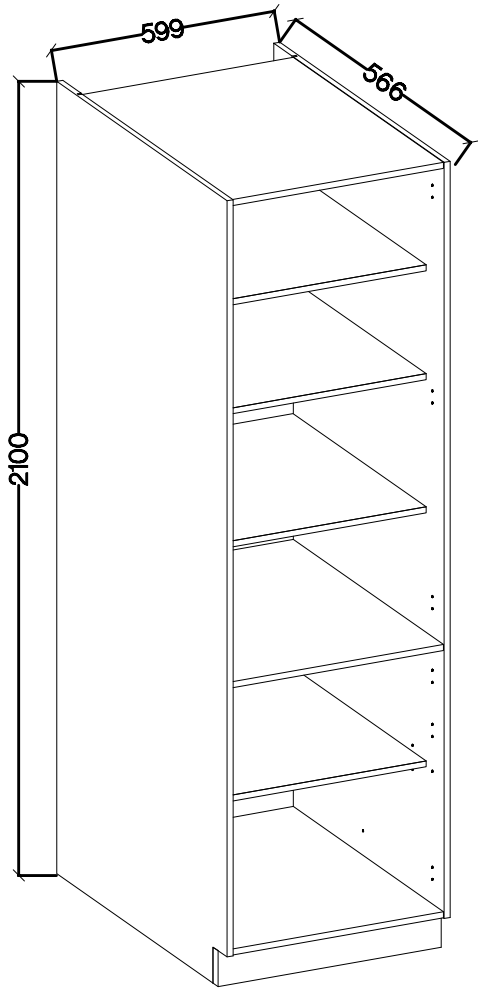
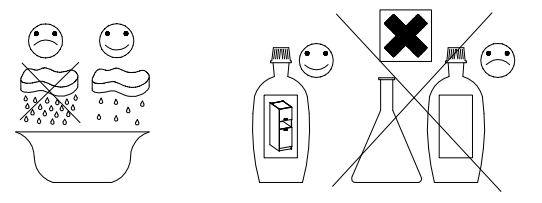
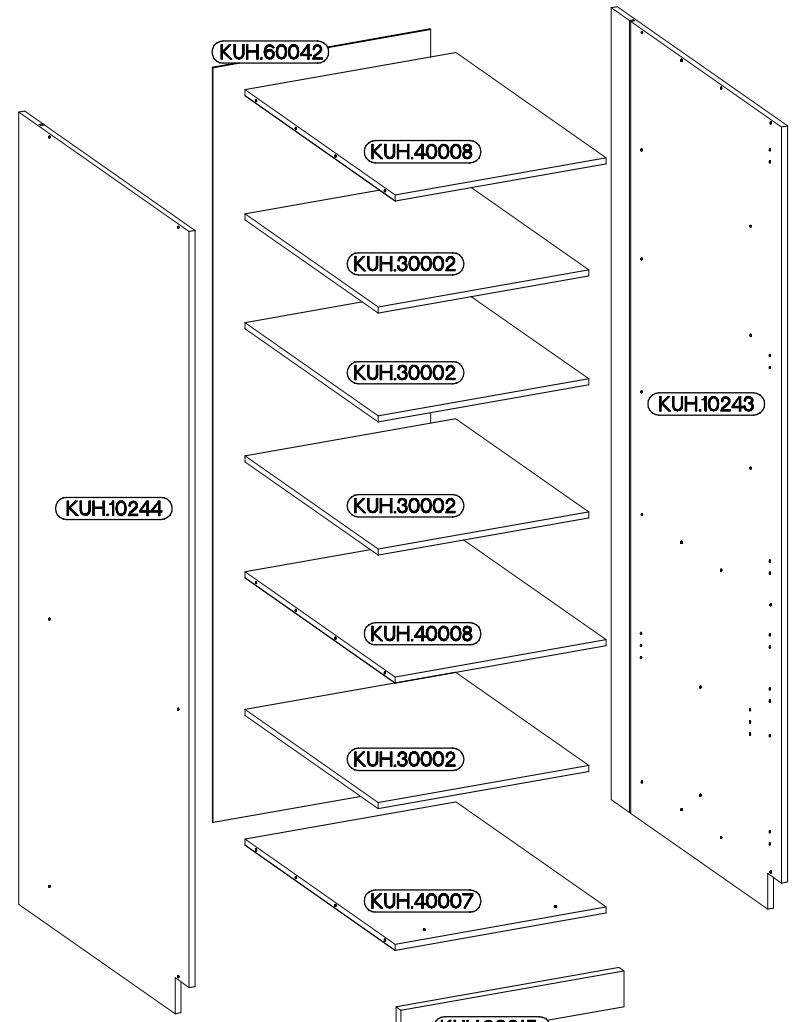
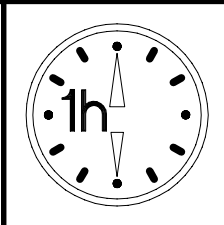

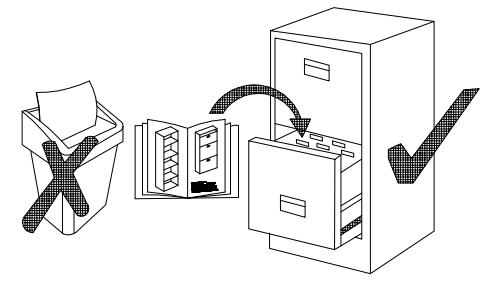
 A 12 6.5x48x16	 B 12 †35/0mm	 E1 12 †5/19mm	 E9 2	 F2 4	 HG 5 †4.0x45mm	 J 16 †3.5x13mm	 K28 2 †3.0x20mm	 K29 1 †4.0x30mm	 L25 1
 O 1	 P4 2	 P5 16	 P7 10-15	 R2 4	 S15 2				



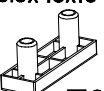

ISM-KUH-00990

1

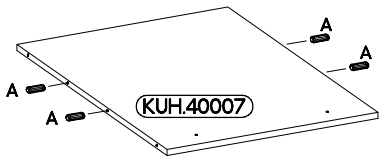
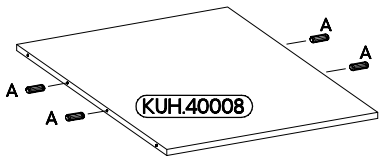
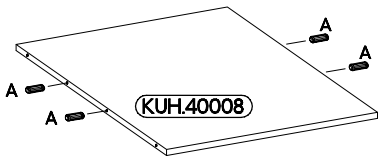
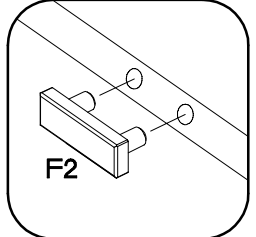
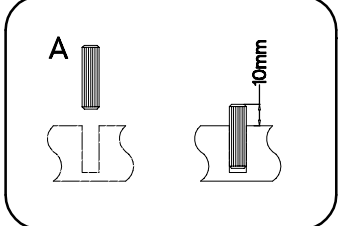
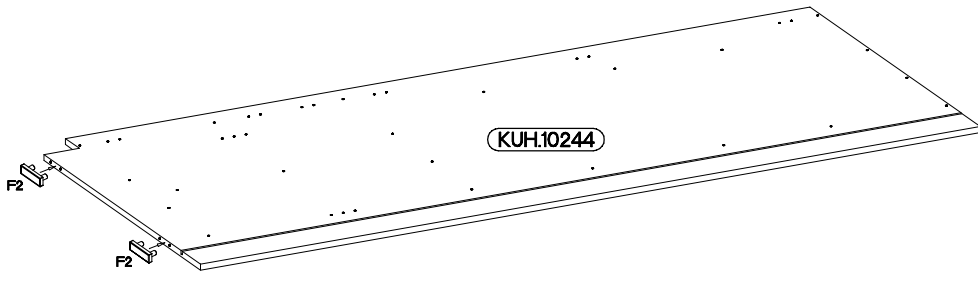
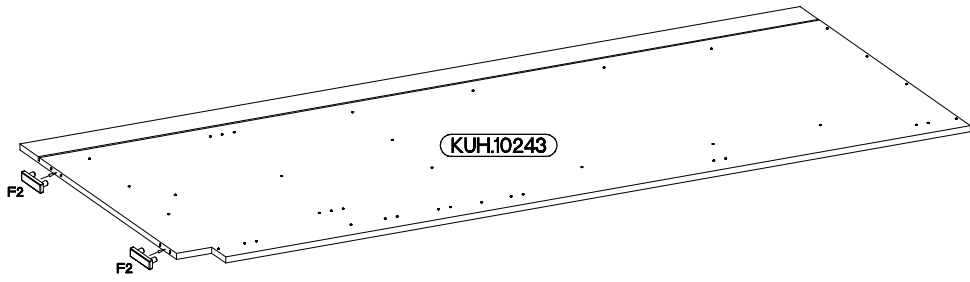
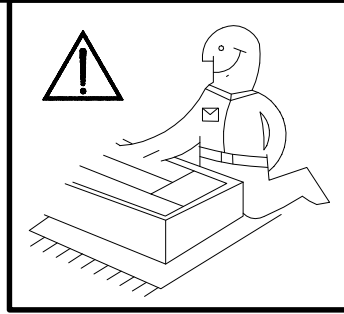
6.5x48x16	+8x30mm
	
F2	A
4	12

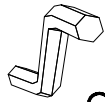

2

6,4 x 50mm			
	B	O	E1
	6	1	6

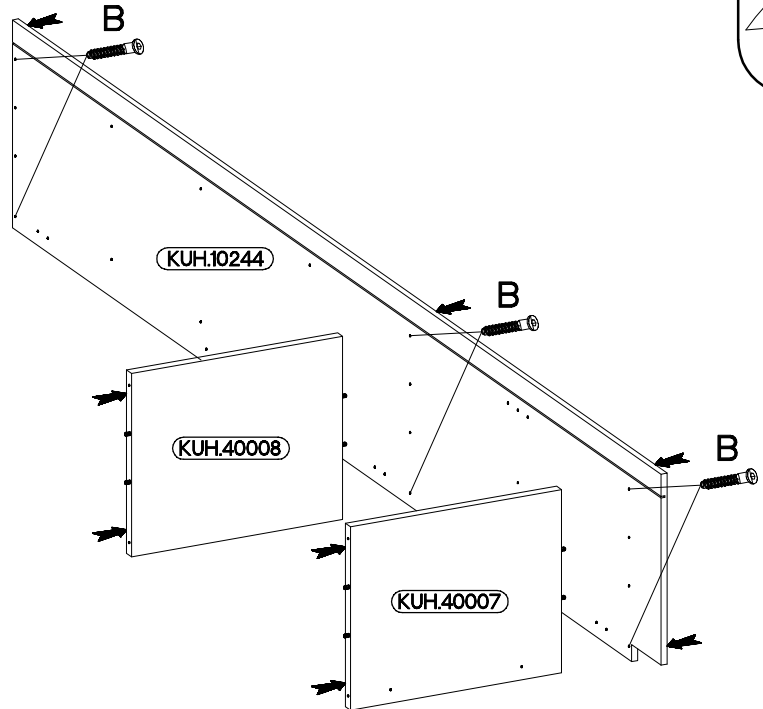
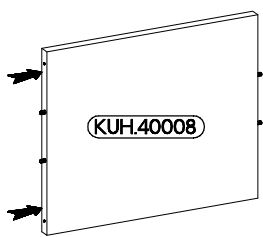
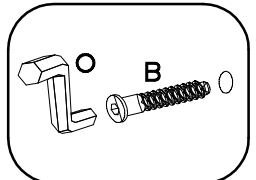
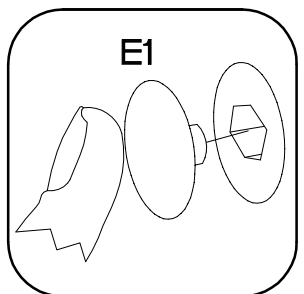

3

6,4 x 50mm

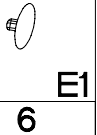
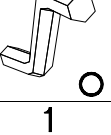
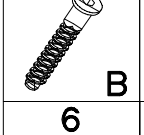

B
6

O
1

E1
6

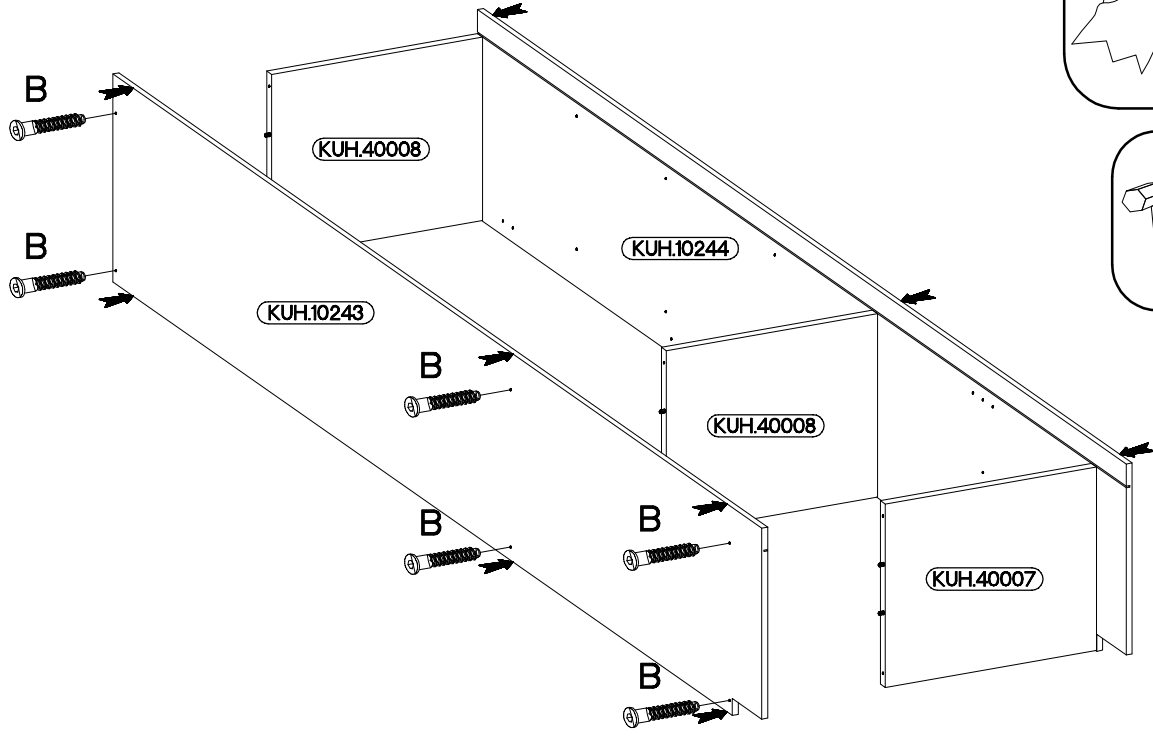
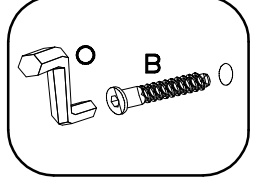
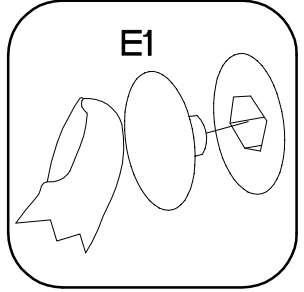

4

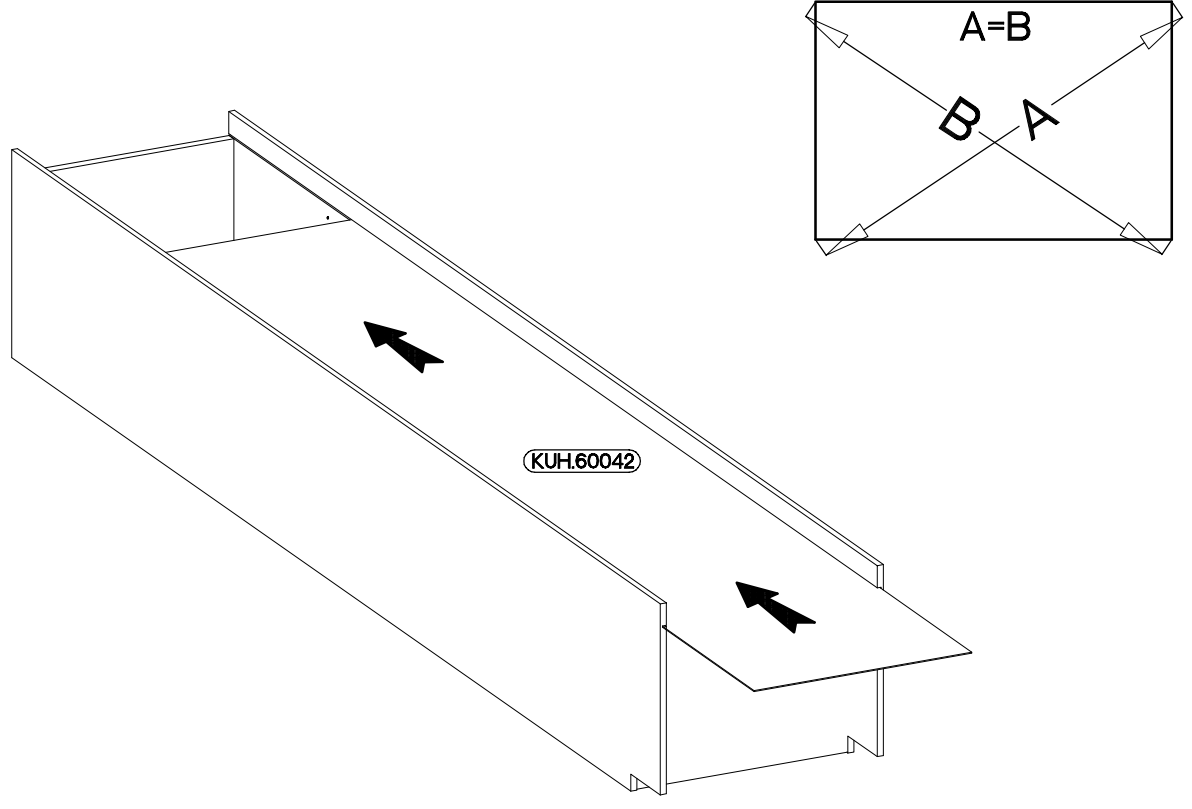

5

±3.0x20mm



P7

10-15

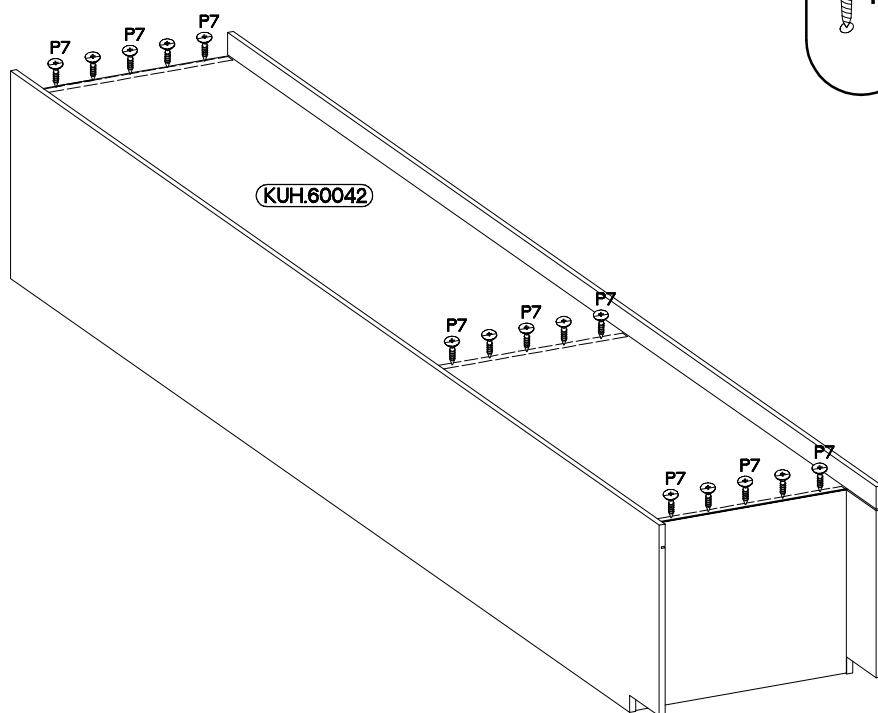
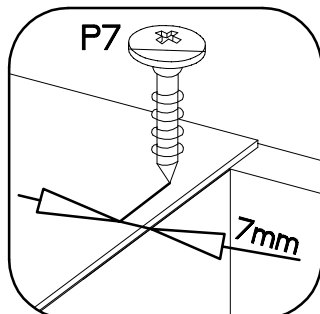
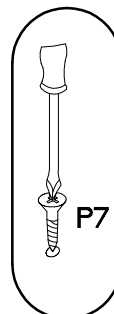

6

±4.0x45mm



P4

2



E9

2

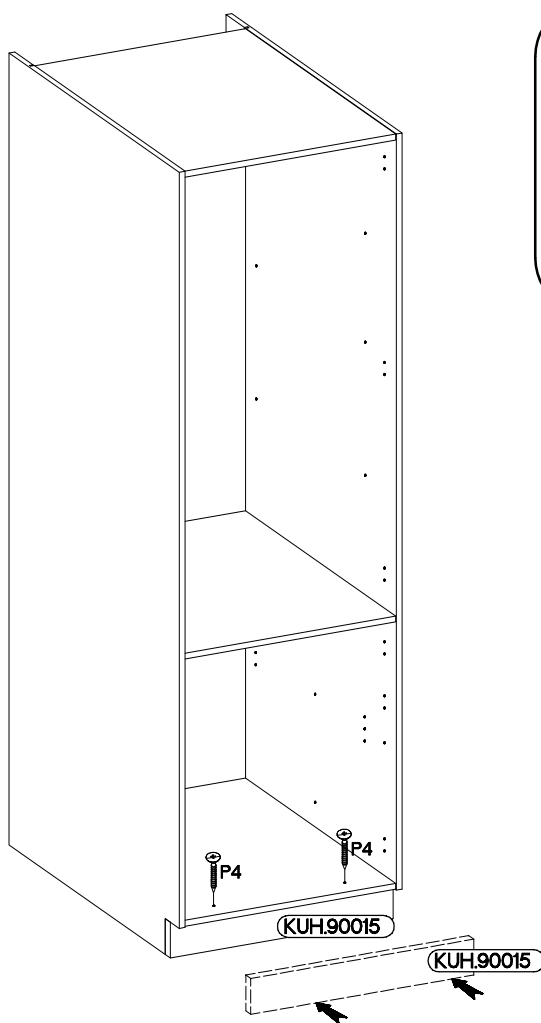
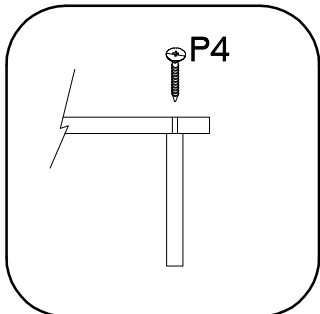
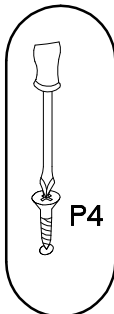

7

±5/19mm



J

16

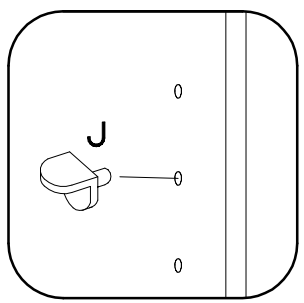
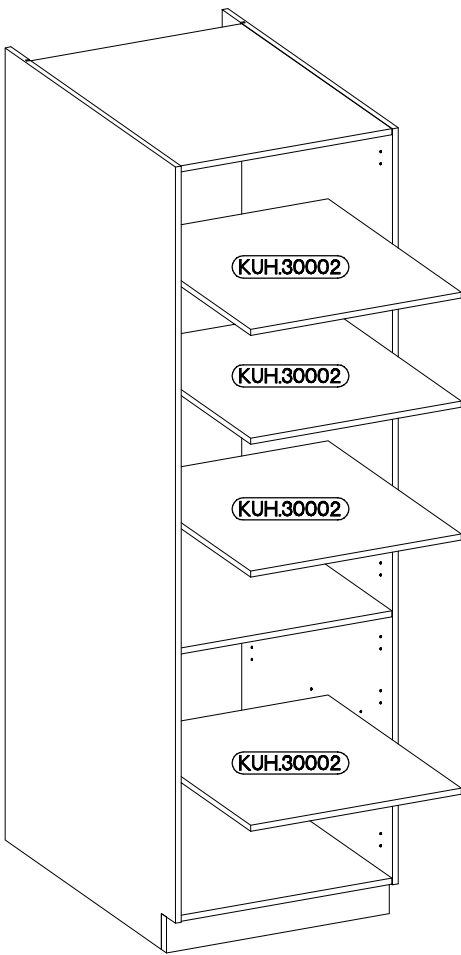

8

±3.5x13mm

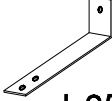

L25

1



P5

2

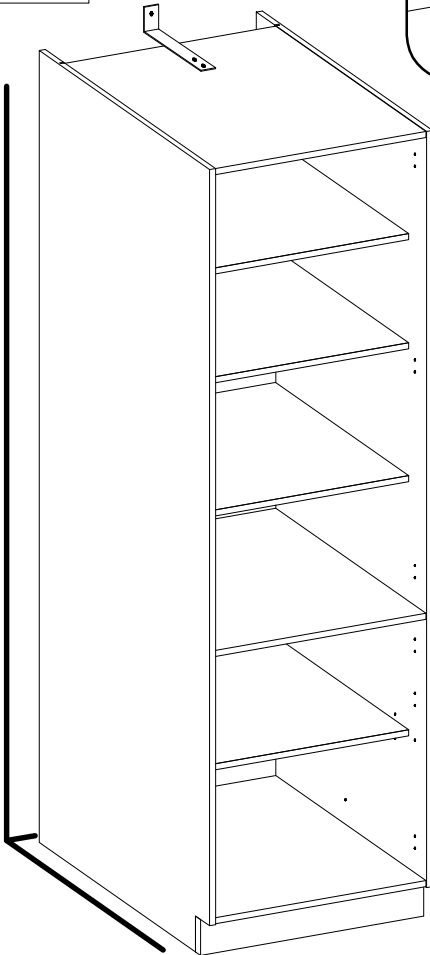

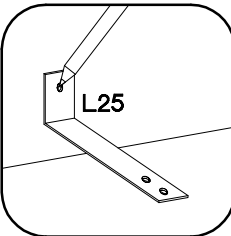
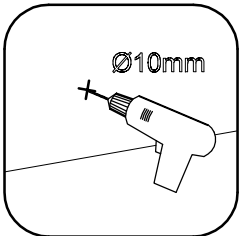
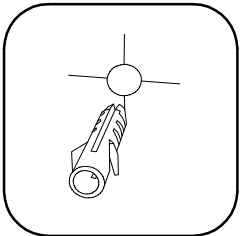
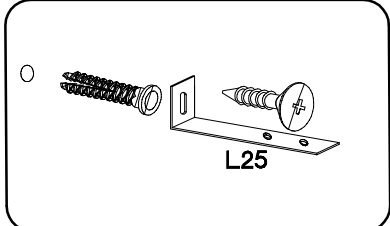
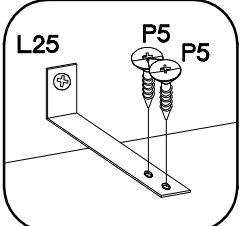

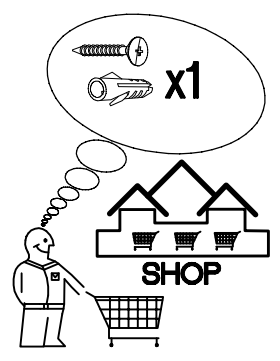
1. 
 2. 
 3. 
 4. 
 5. 
-

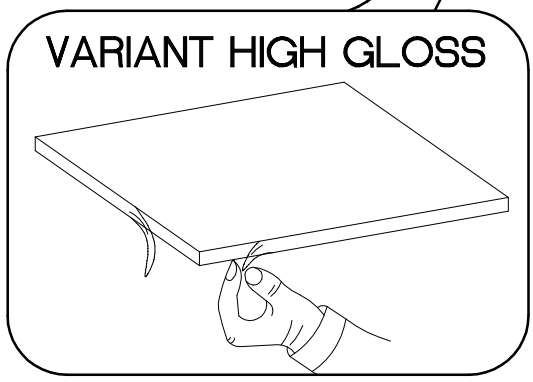
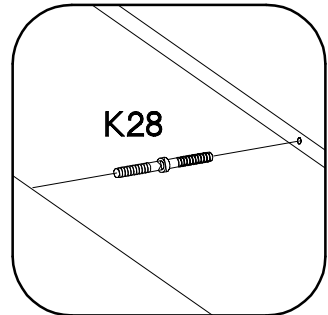
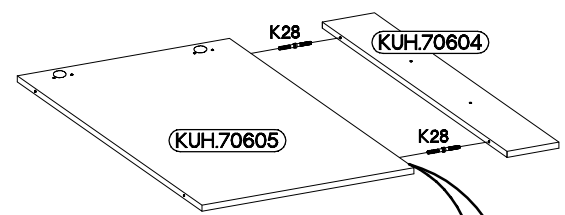
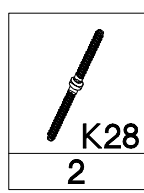
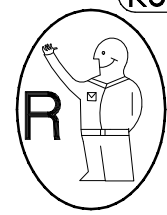
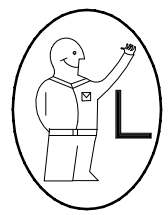
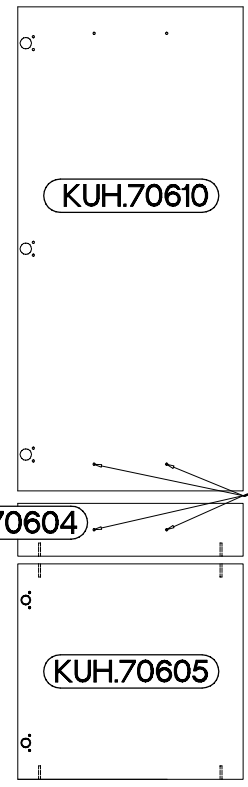
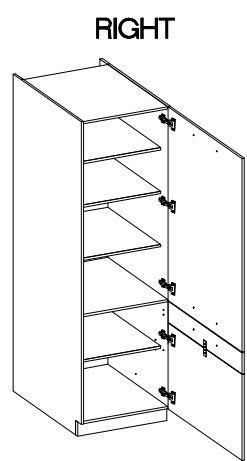
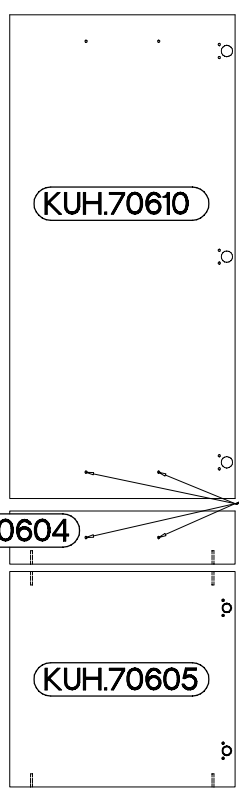
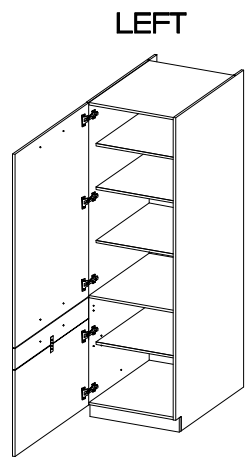
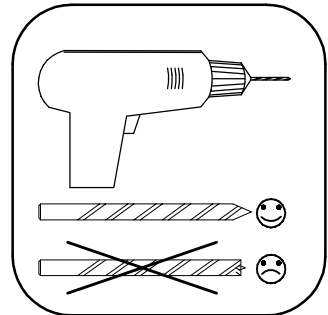
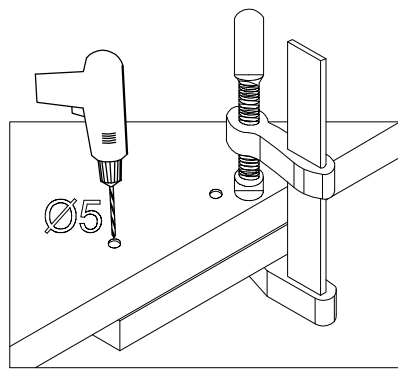
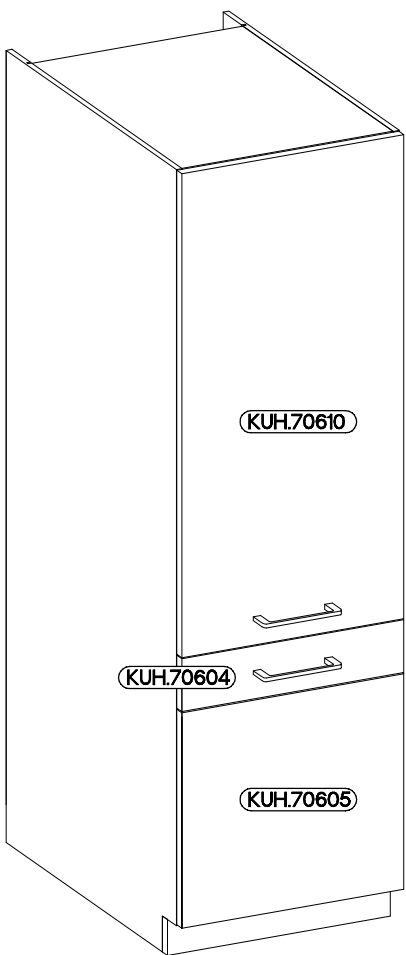



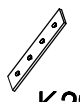

11

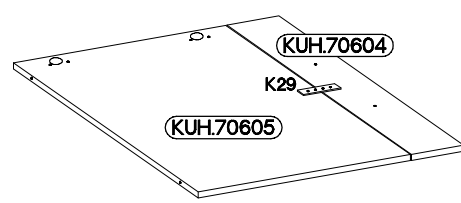
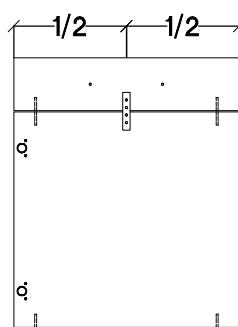
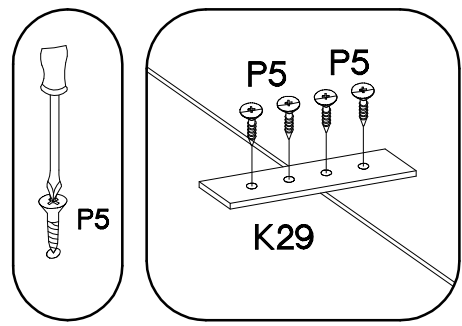
	±3.5x13mm 
K29	P5
1	4

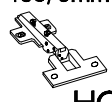

12

±35/0mm 	±3.5x13mm 
HG	P5
5	10

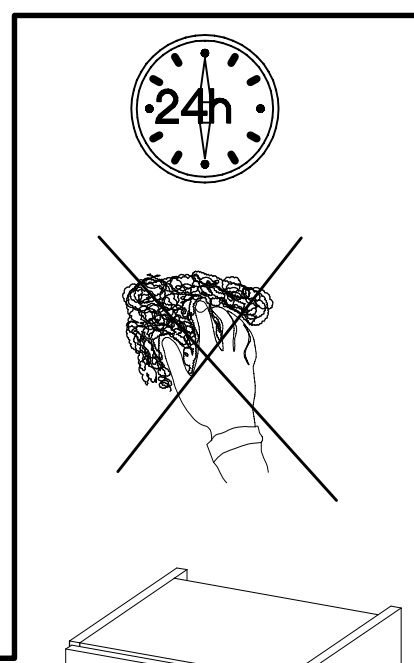
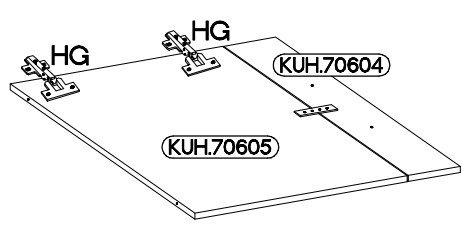
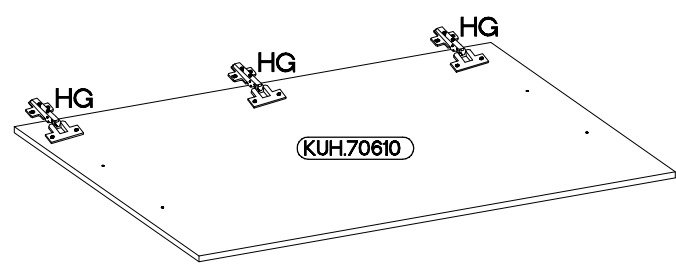
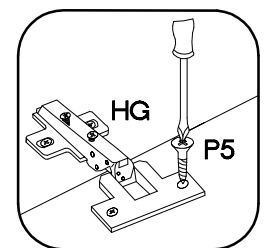
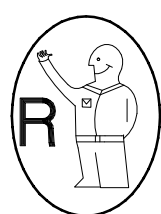

VARIANT HIGH GLOSS

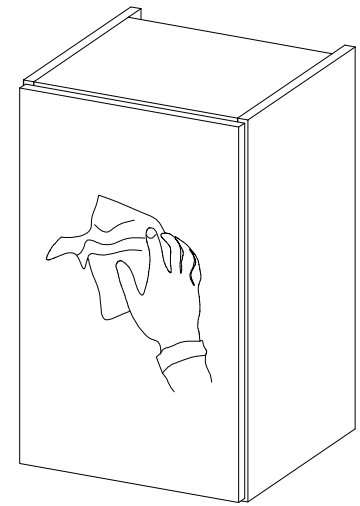
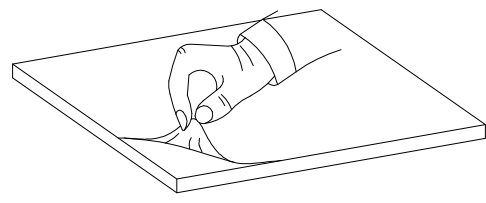
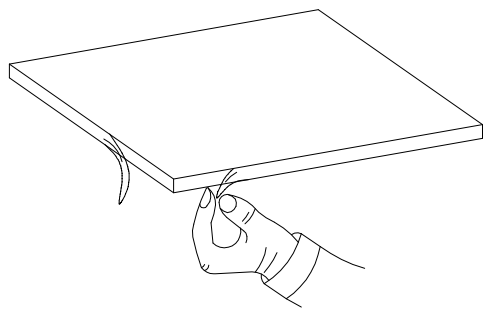

+4.0x30mm

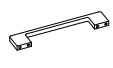
 R2 4	 S15 2
---	--

