

FRONT

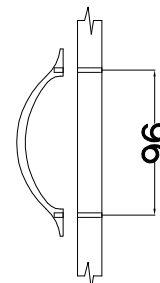

60 DK-2100 2F

60 LO-2100

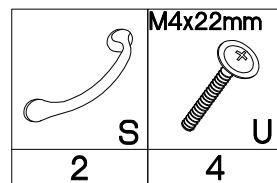
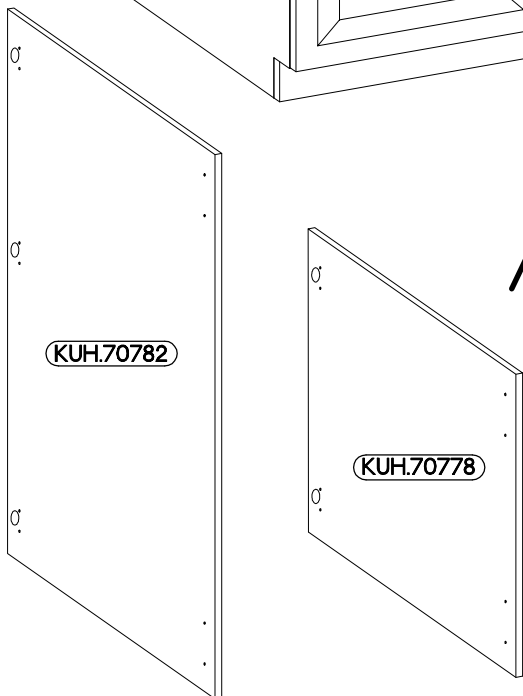
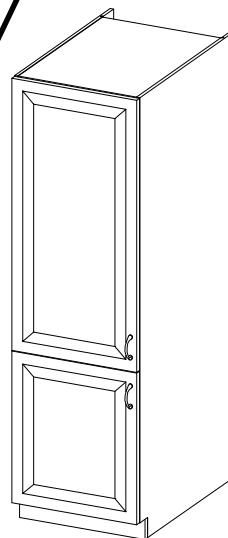
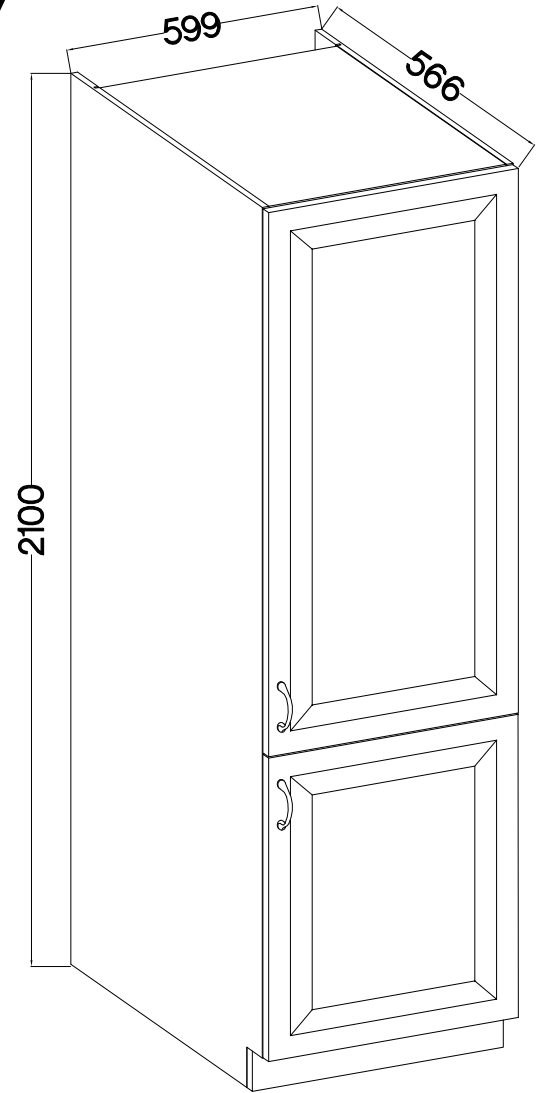
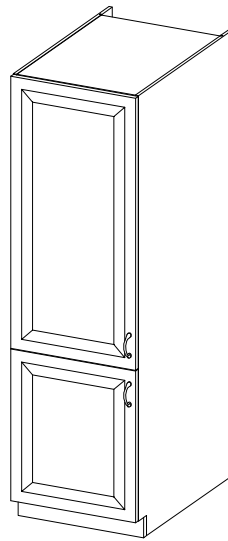
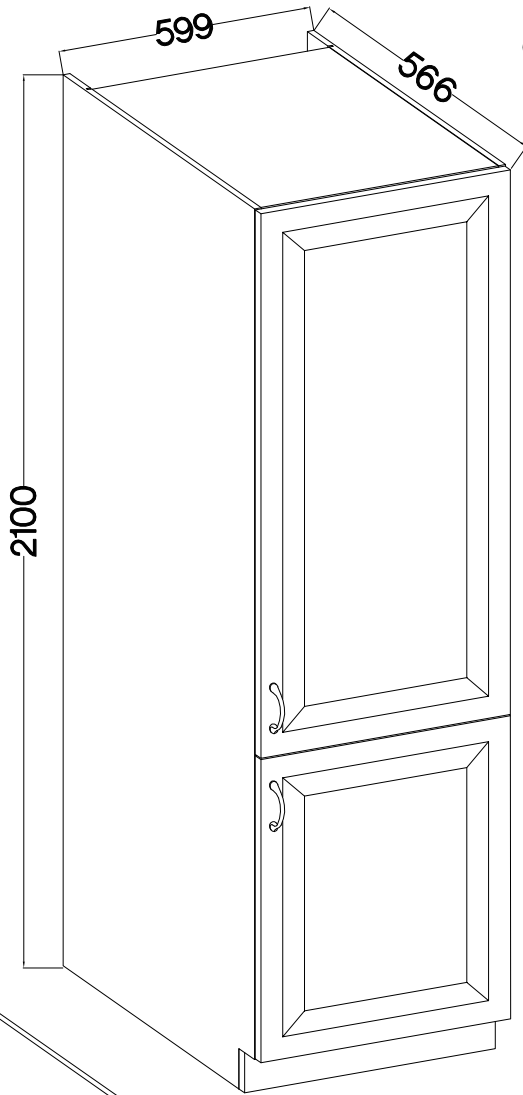

ISM-KUH-01205

1 60 DK-2100 2F

LEFT

RIGHT

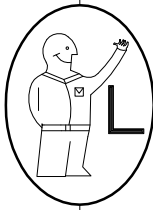
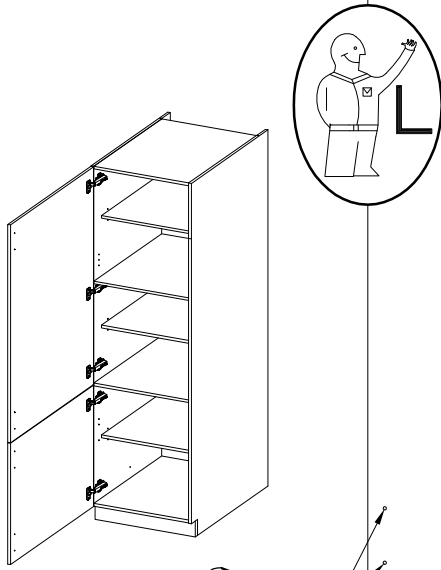
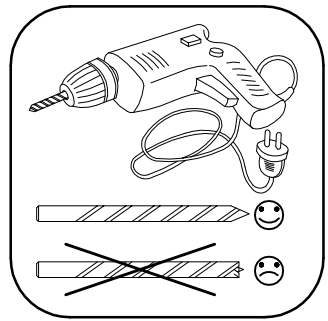

KUH.70782

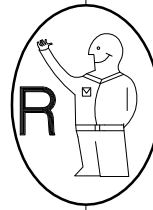
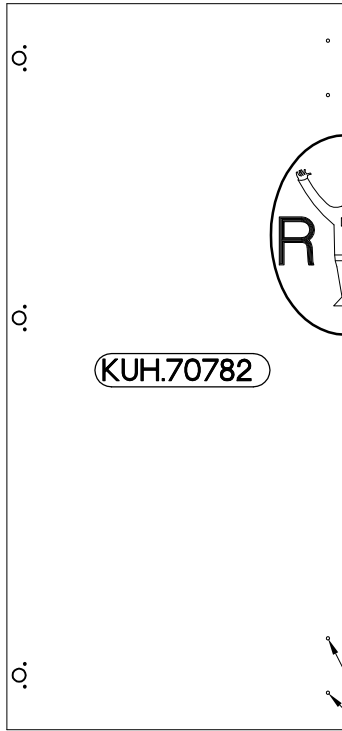

KUH.70782

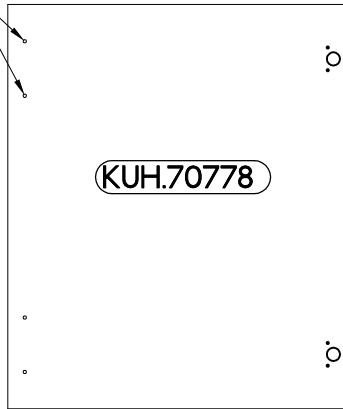
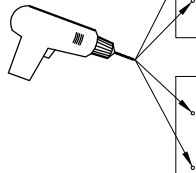
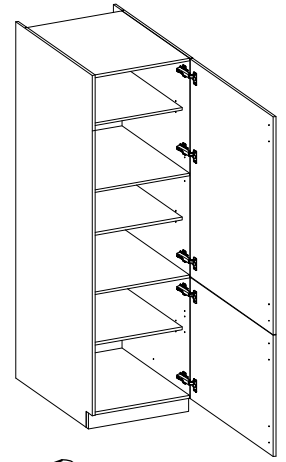

KUH.70778

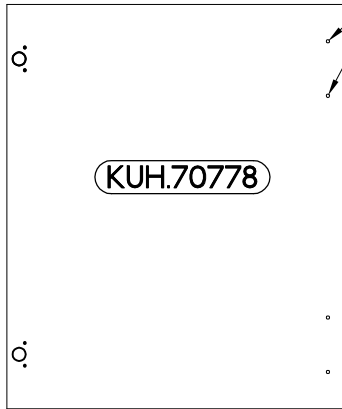

KUH.70778

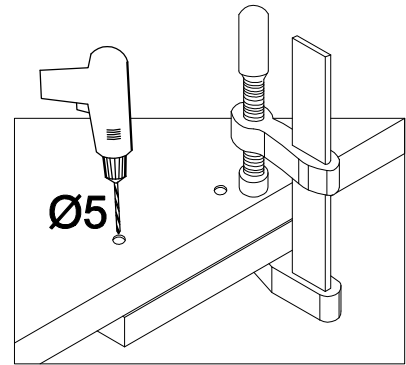
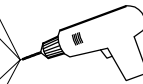

Ø5

2

±35/0mm	±3.5x13mm
HG	P5
5	10

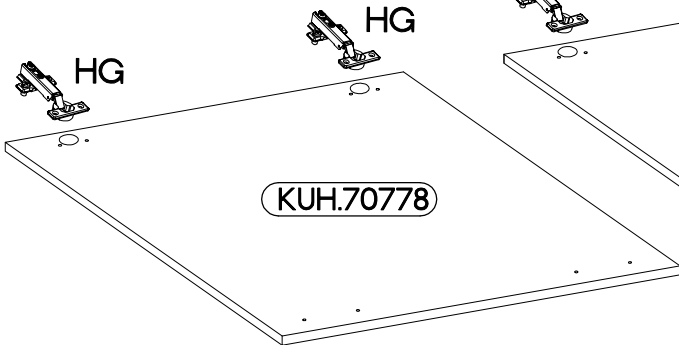

KUH.70778

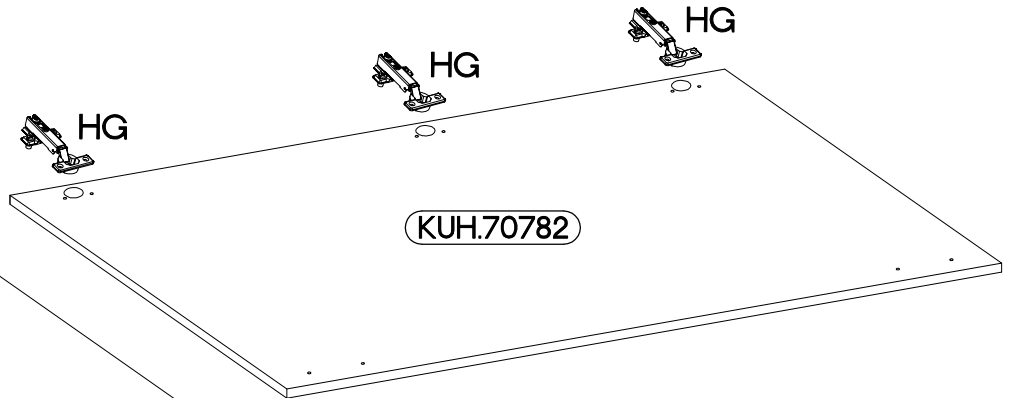

KUH.70782

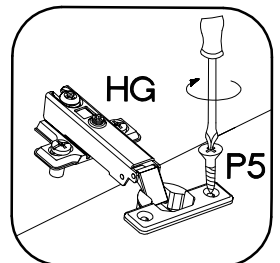

HG

P5

3

M4x22mm



U

4



S

2

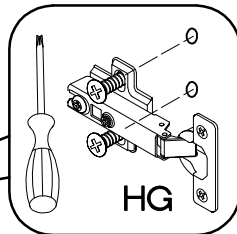

HG

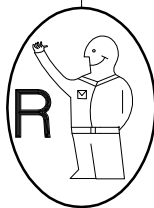

R

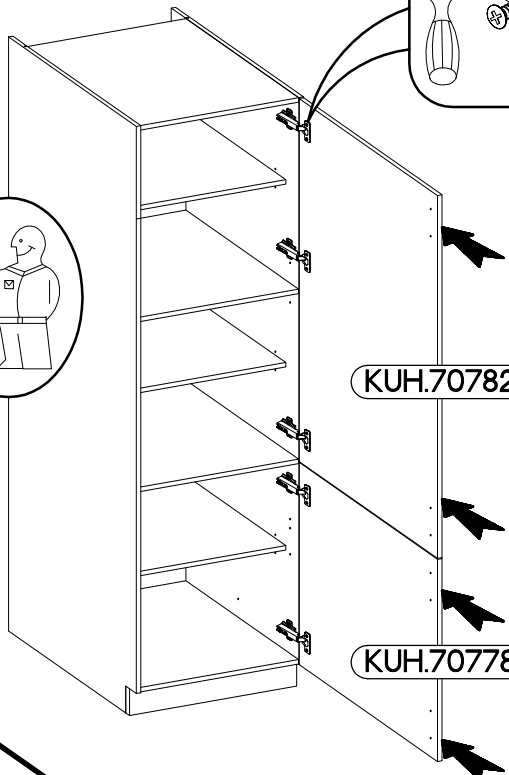

KUH.70782

KUH.70778

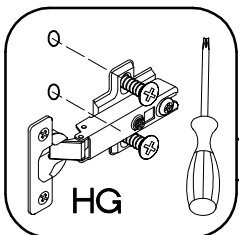

HG

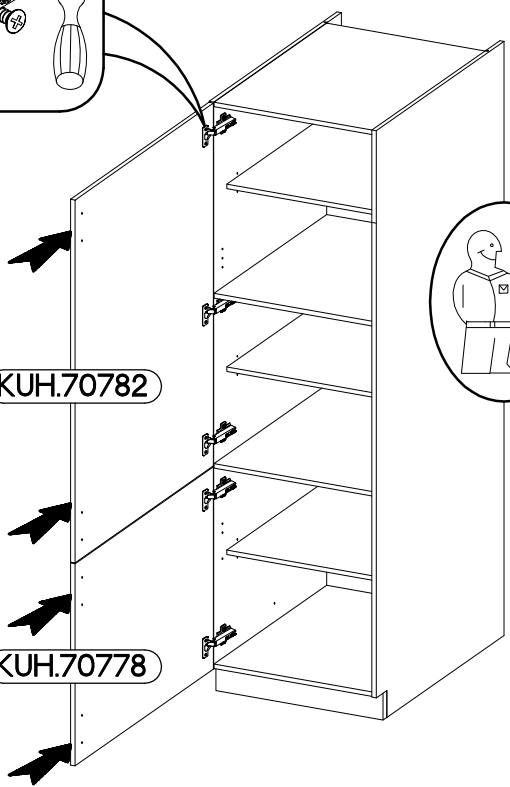

KUH.70782

KUH.70778

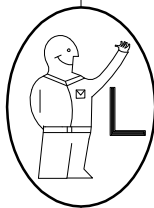

L

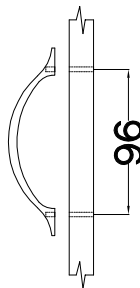

96

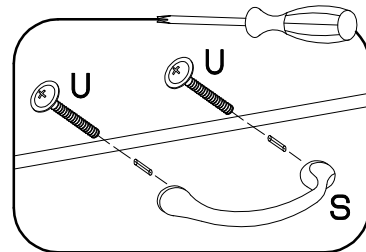

U

S

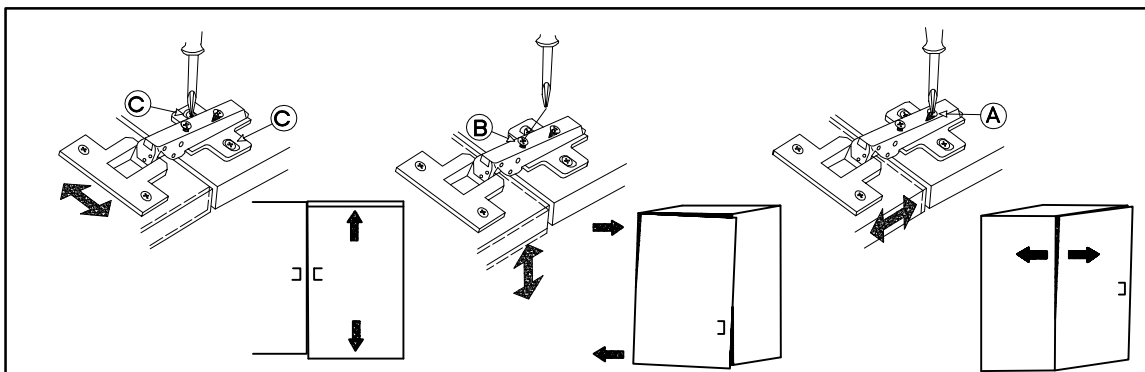

C

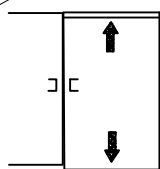

C

B

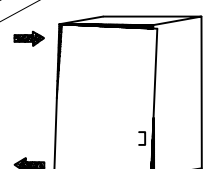

B

A

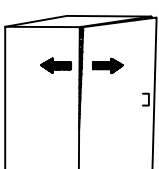

A