

60 LO-2100

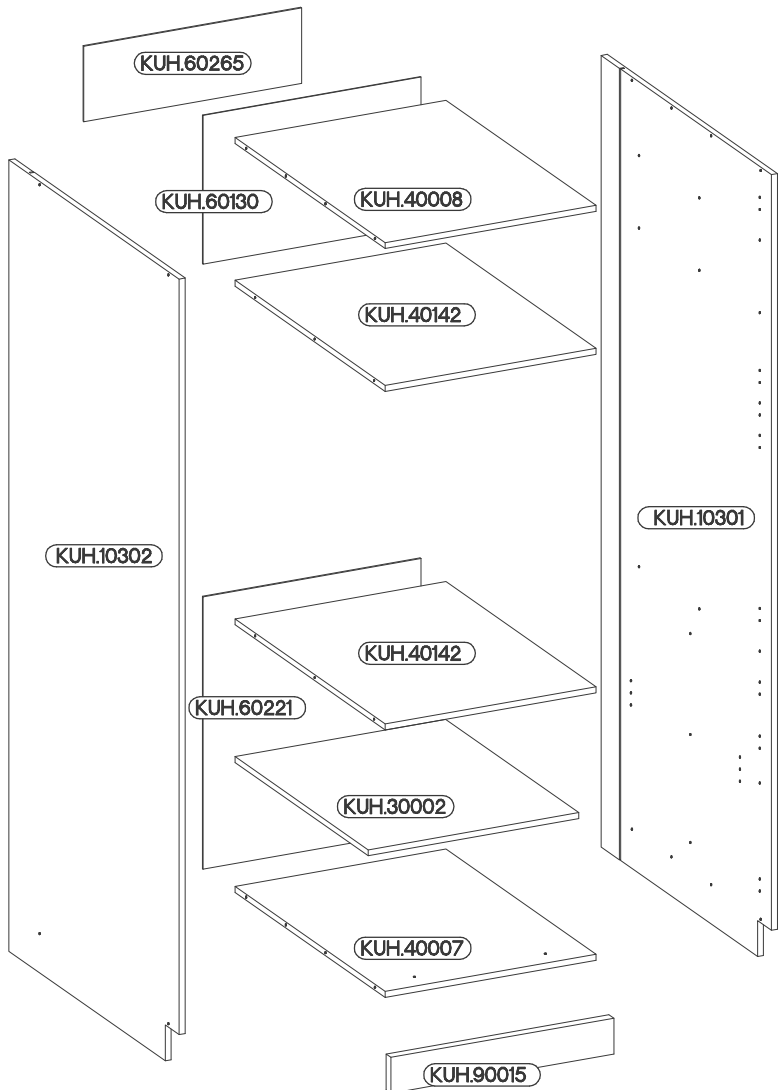

 +8x30mm A	 6,4 x 50mm B					
8	8					
 +15/12mm C	 L=20mm D2	 E	 E1	 E9		
12	12	12	8	2		
 6.5x48x16 F2	 +35/0mm HG	 +5/19mm J	 K28	 K29	 L25	 O
4	5	4	2	1	1	1
 +4.0x16mm P1	 +4.0x45mm P4	 +3.5x13mm P5	 +3.0x20mm P7	 +4.0x30mm R2	 S15	 T4
16	2	16	15-20	4	2	4

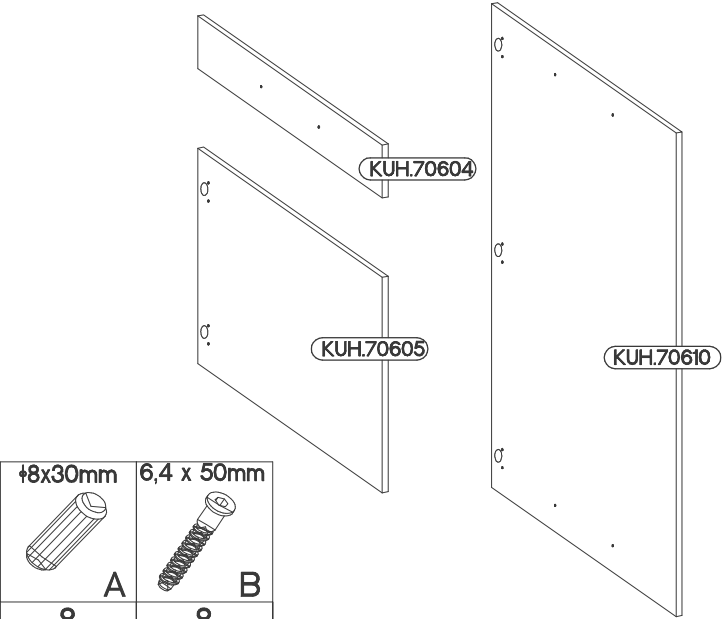
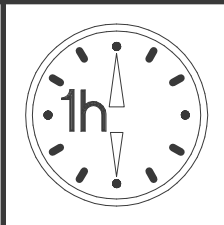
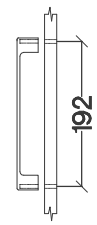
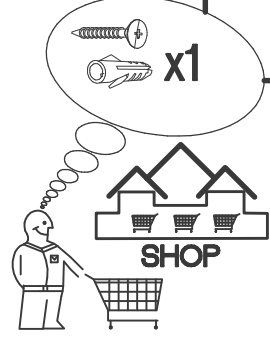
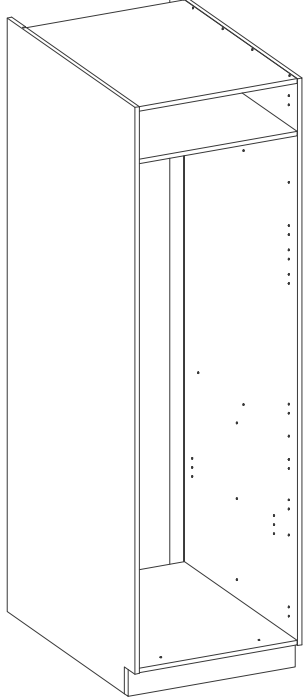
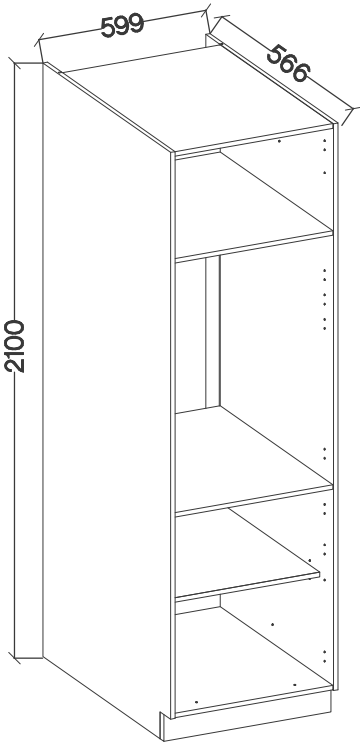
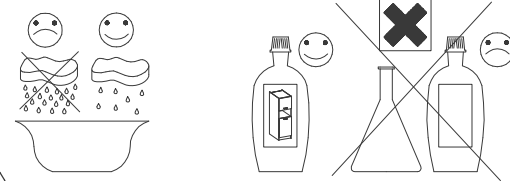
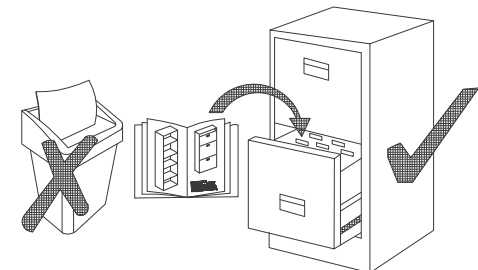

WARIANT A

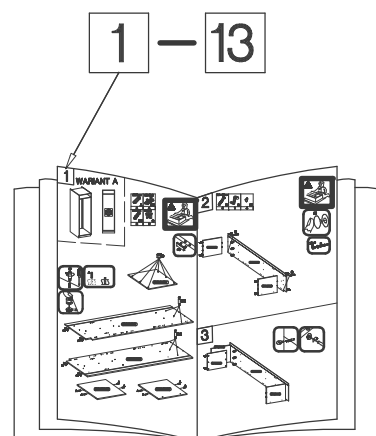
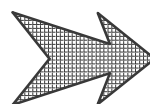
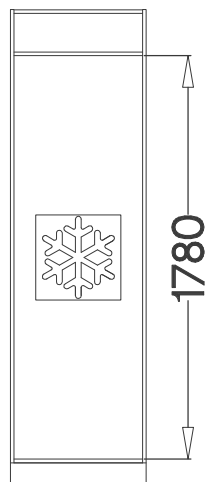
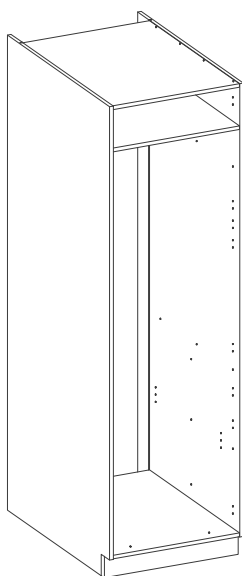
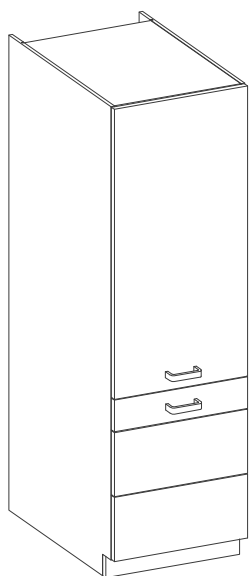

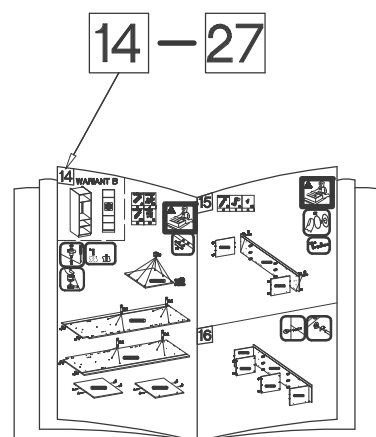
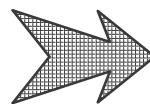
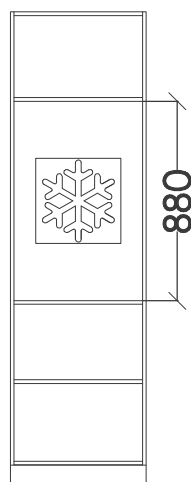
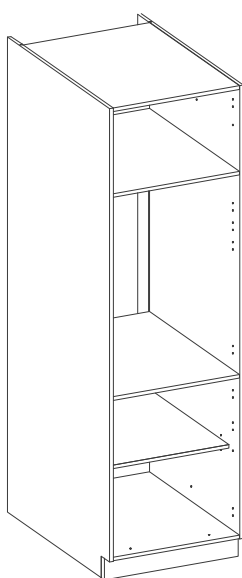
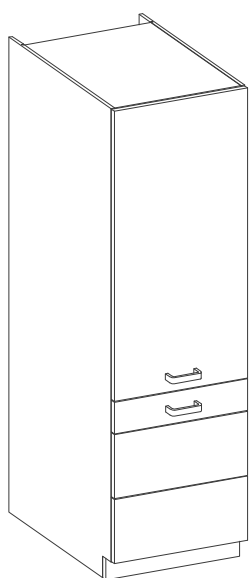

WARIANT B

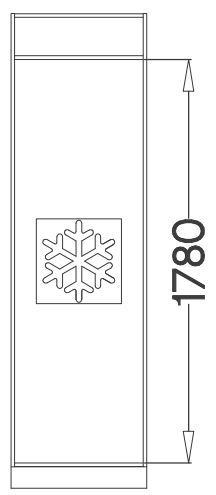
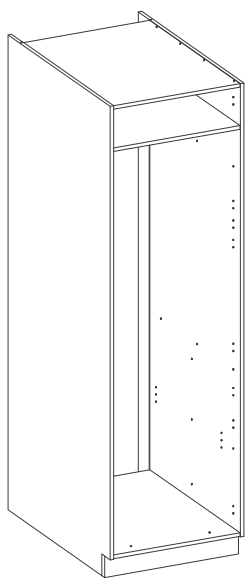

1

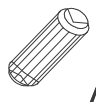

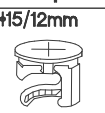
$\varnothing 8 \times 30 \text{mm}$  A	$6.5 \times 48 \times 16$  F2
8 L=20mm  D2	4 $\varnothing 15 / 12 \text{mm}$  C
6	6

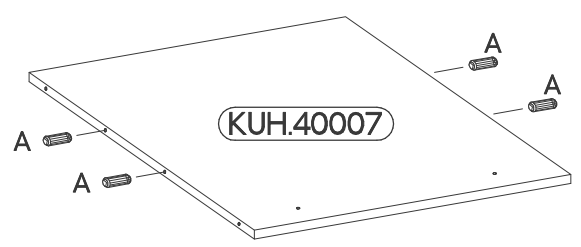
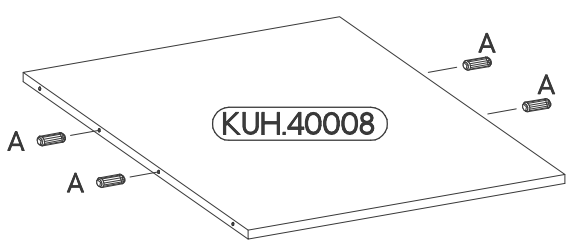
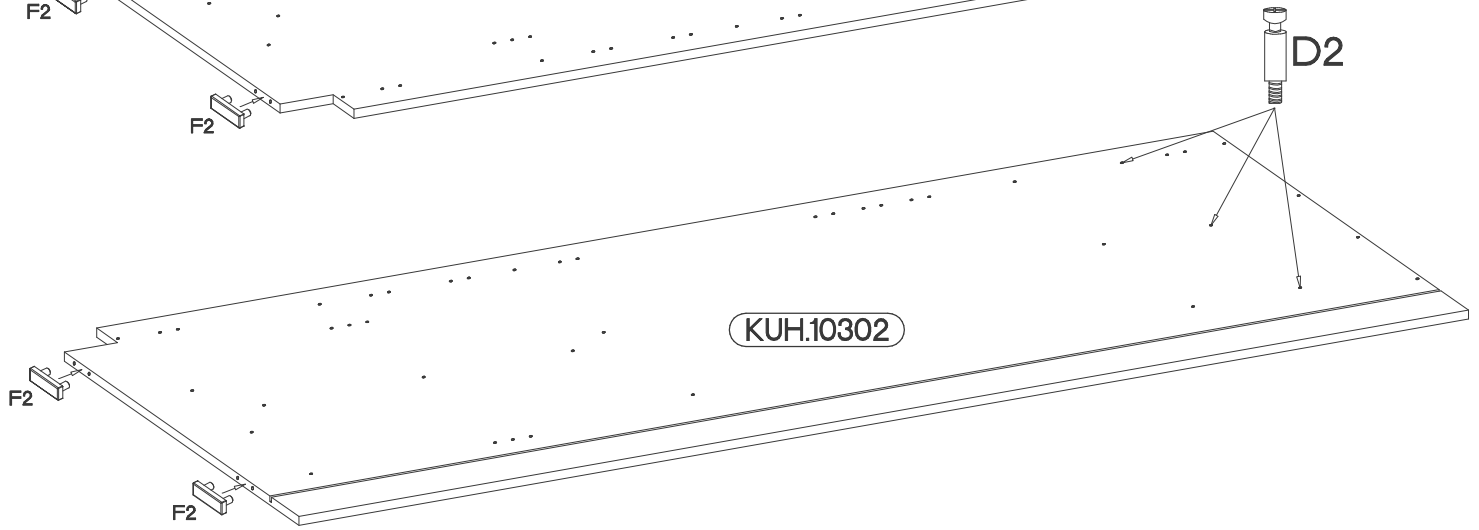
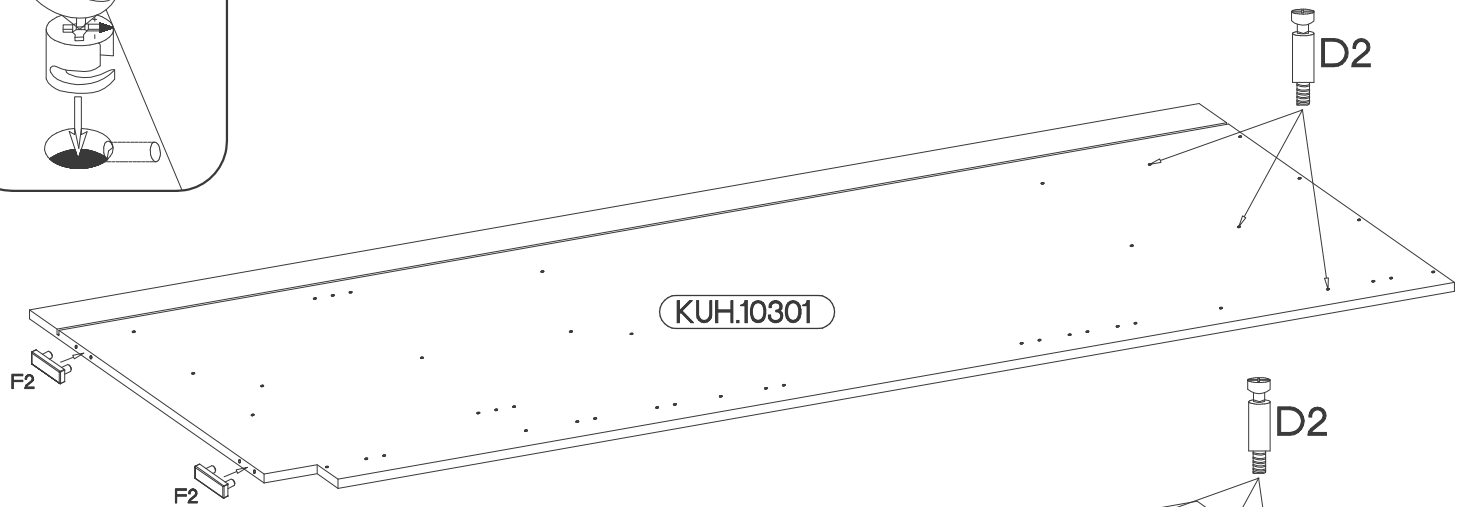
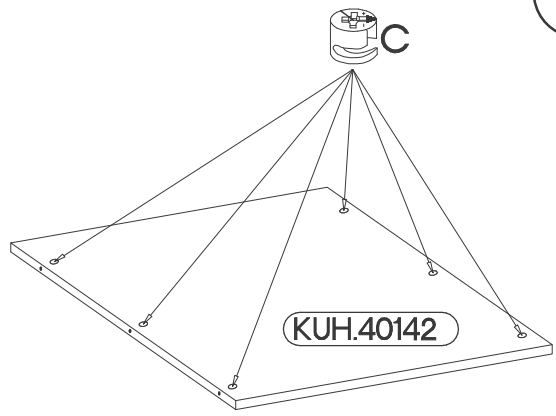
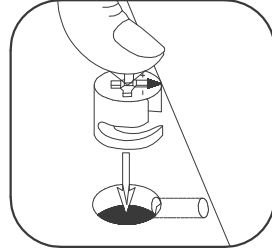
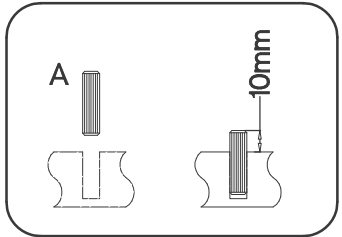
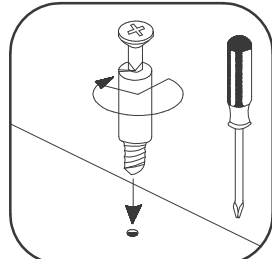
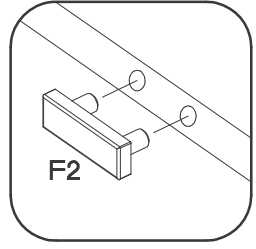
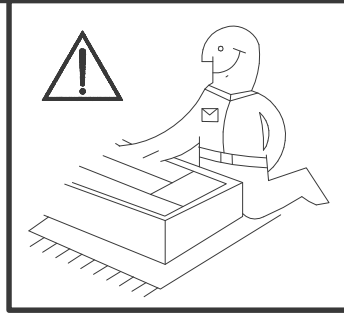

2

6,4 x 50mm

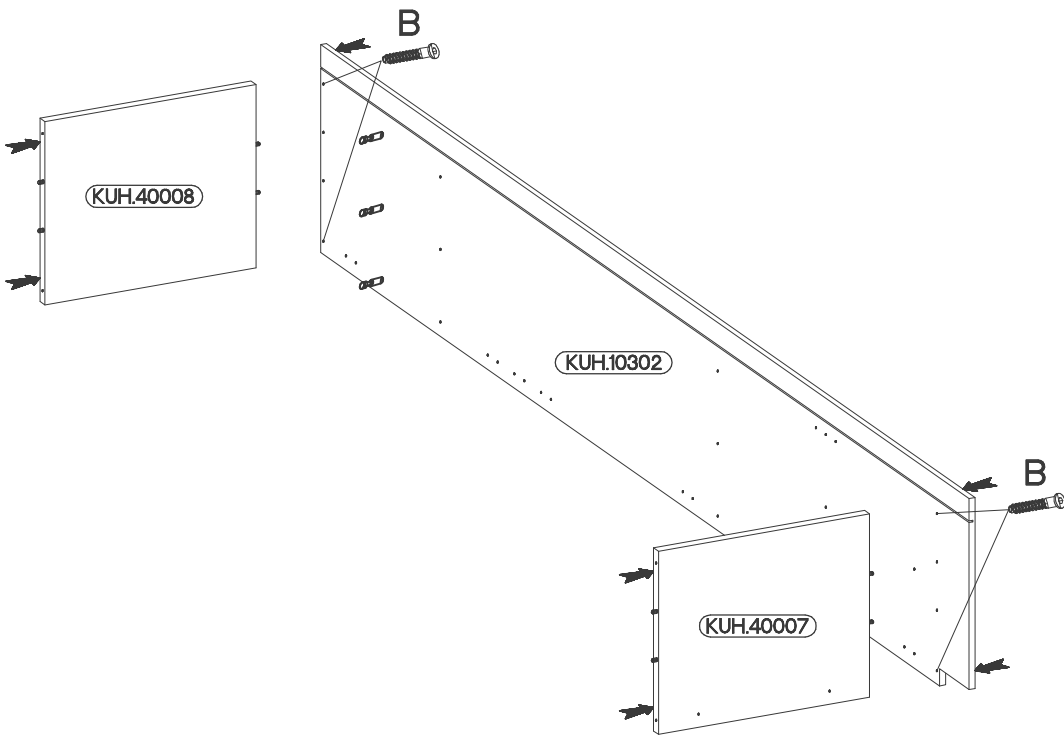
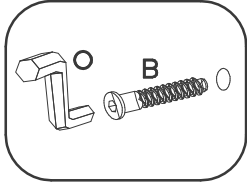
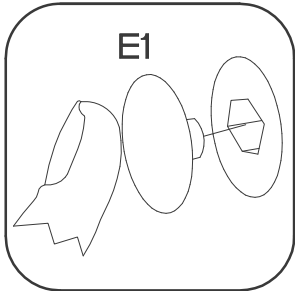
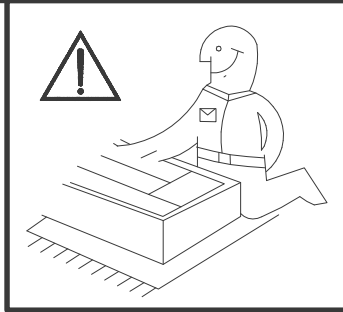
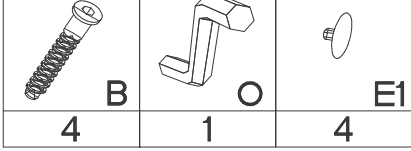



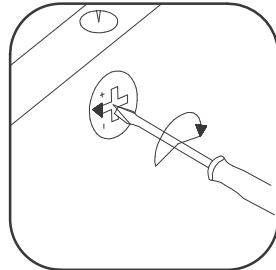
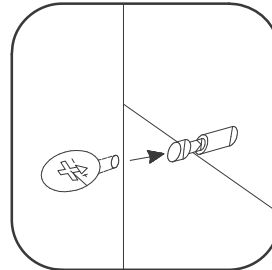
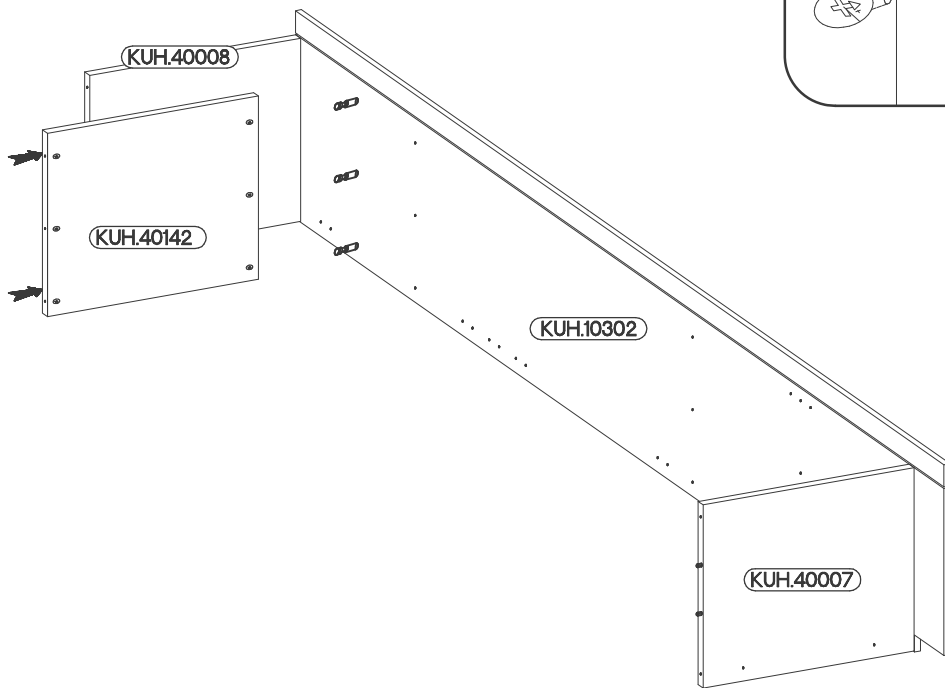

3





4

6,4 x 50mm

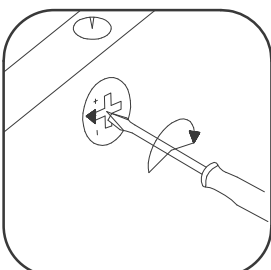
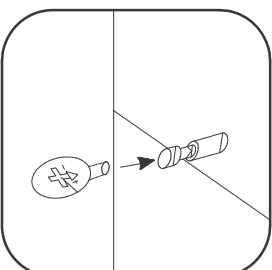
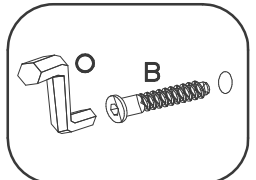
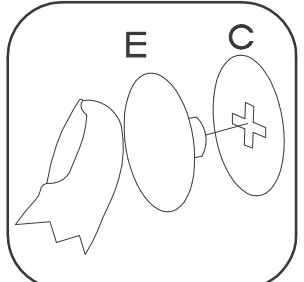
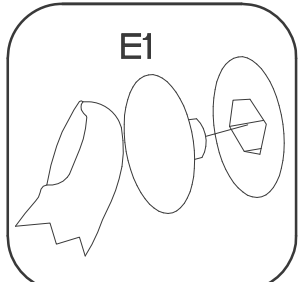
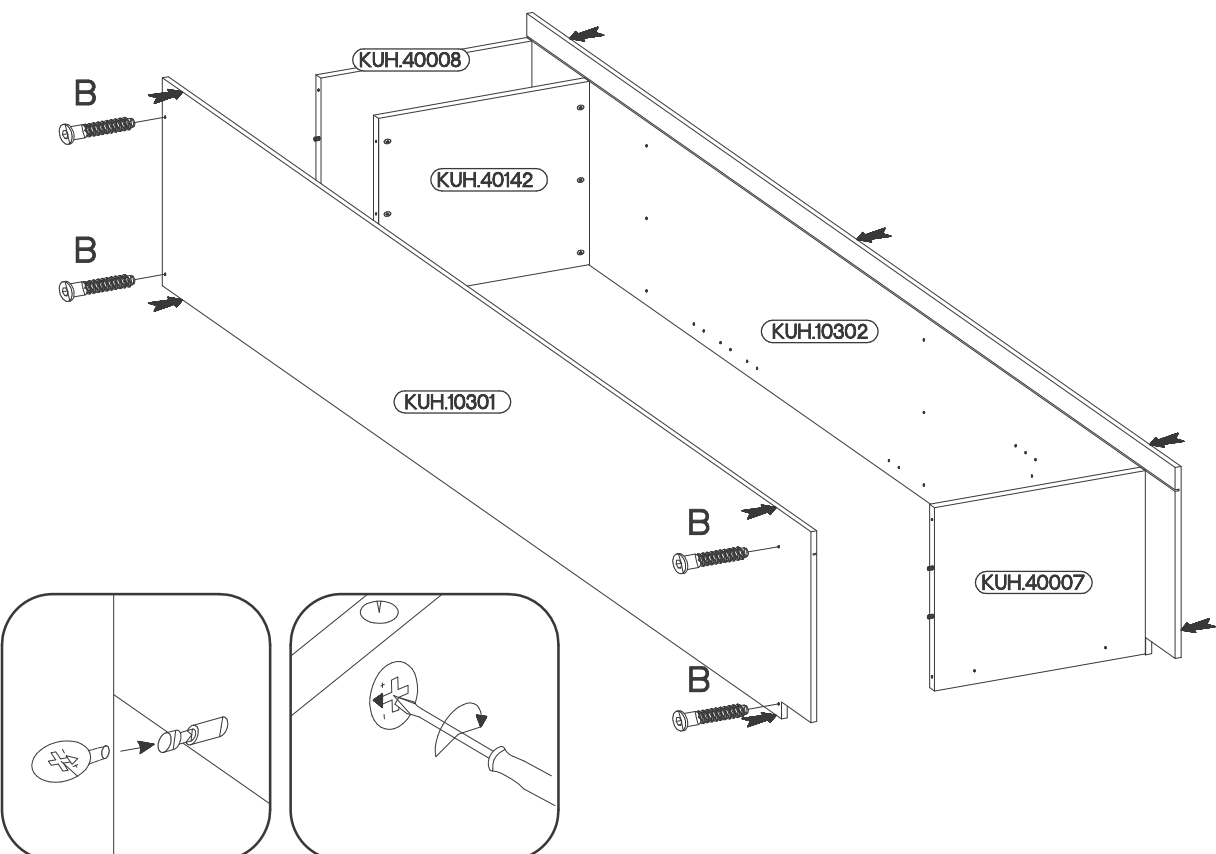
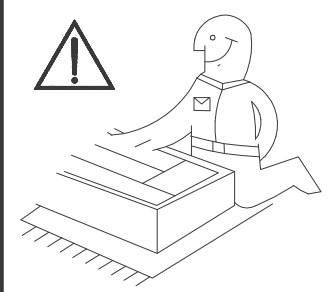
			
B	O	E1	E
4	1	4	6

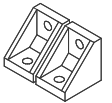

5

	
T4	P1
4	16

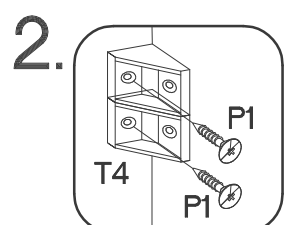
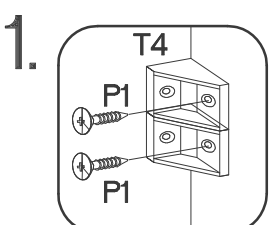
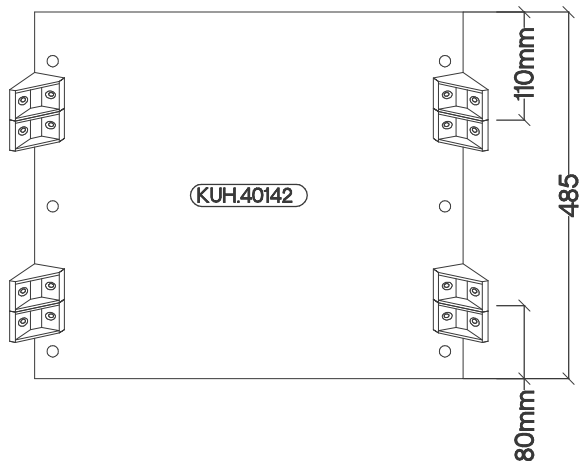
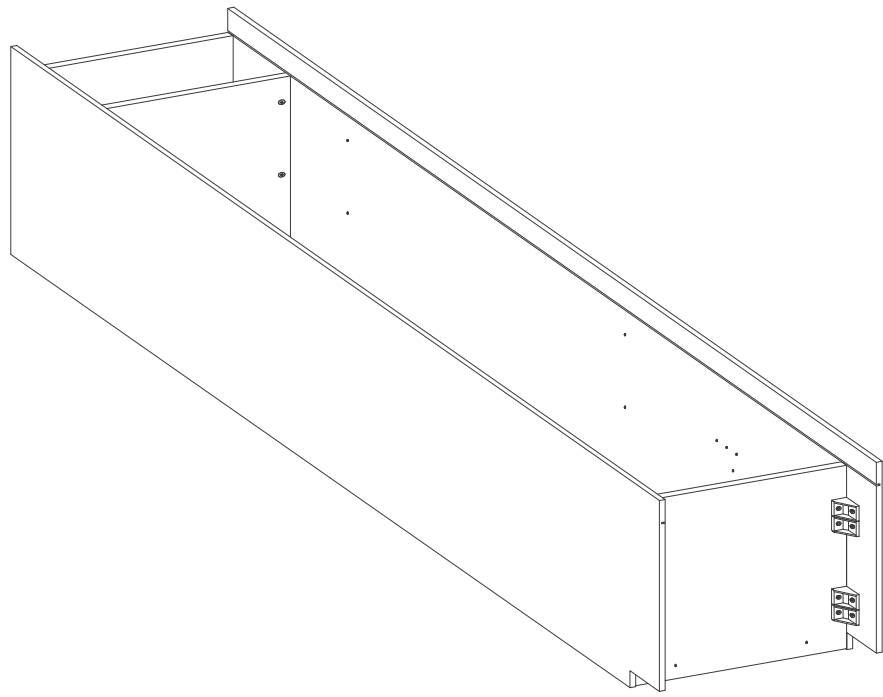

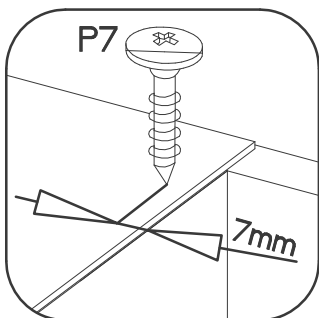
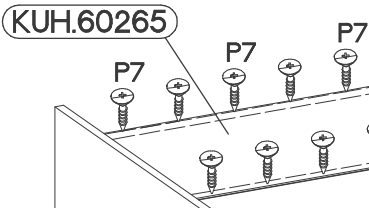
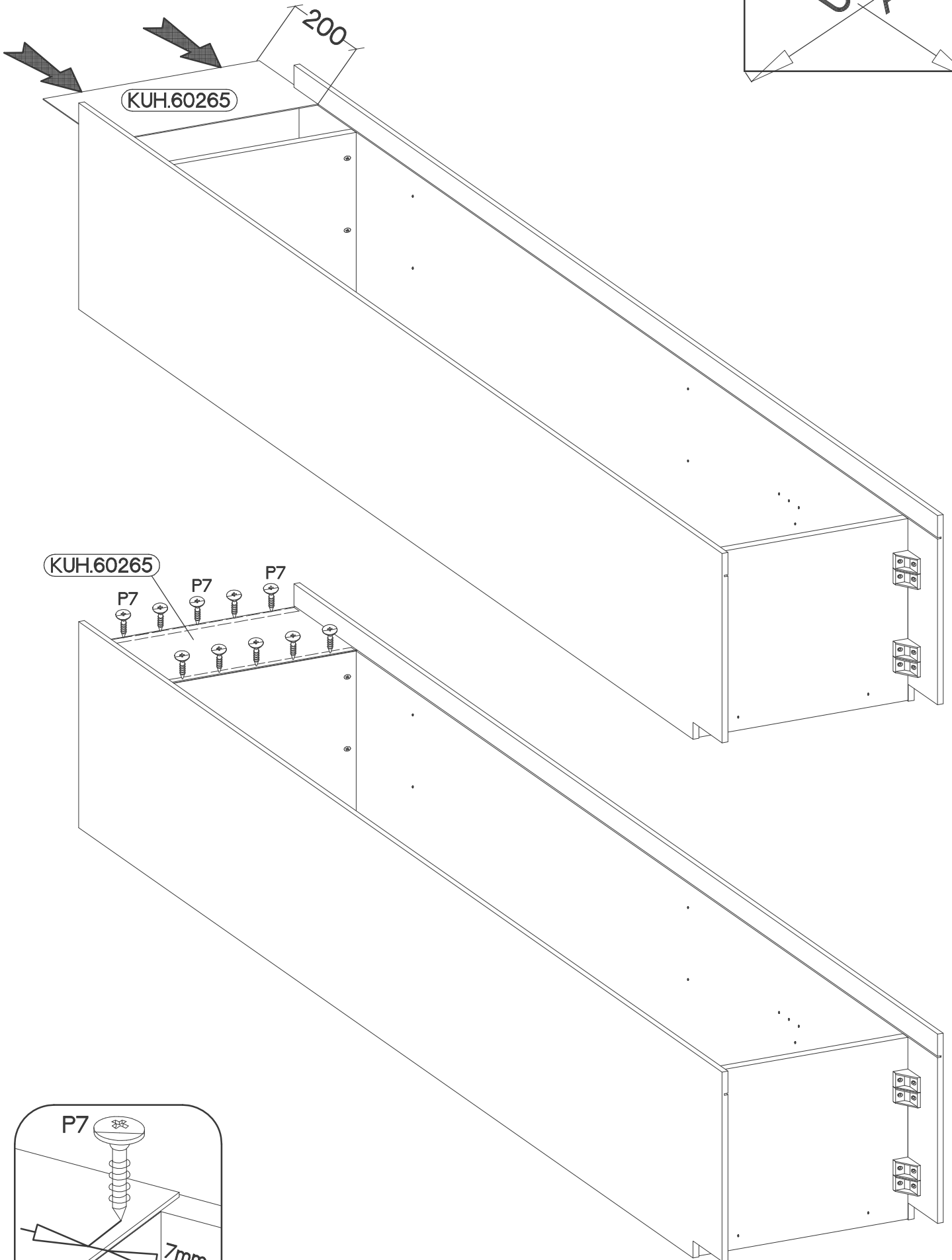
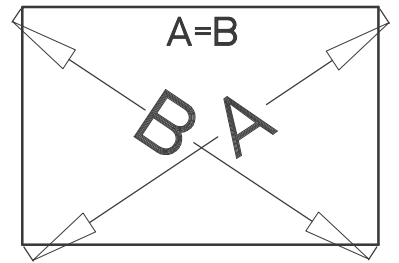

6

±3.0x20mm
P7
8-10



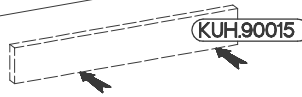
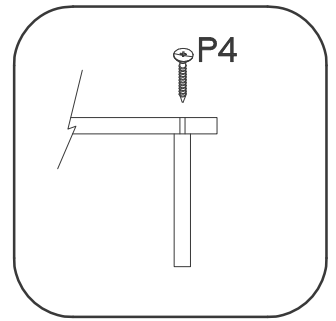
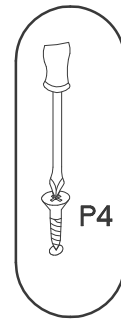
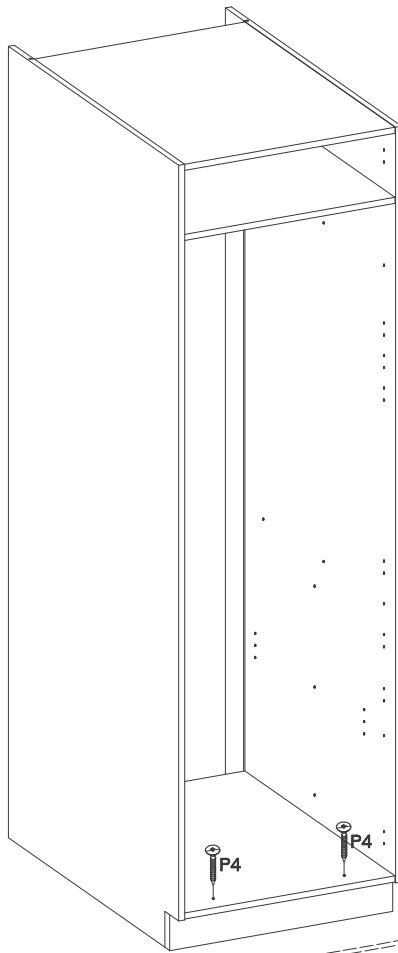

7

$\dagger 4.0 \times 45 \text{mm}$  P4 2	 E9 2
---	--

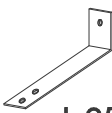

8

 L25 1	$\dagger 3.5 \times 13 \text{mm}$  P5 2
--	--

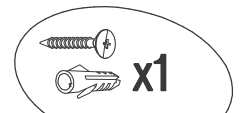
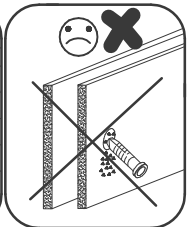
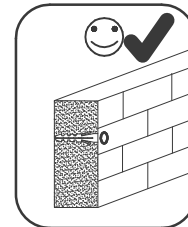
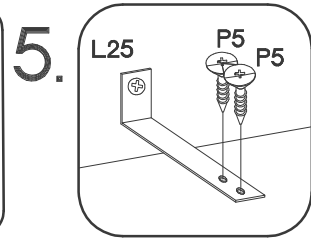
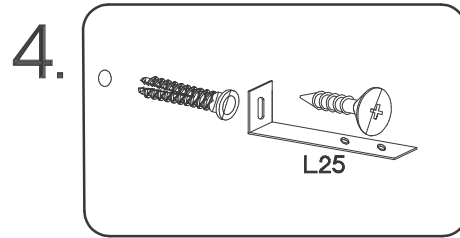
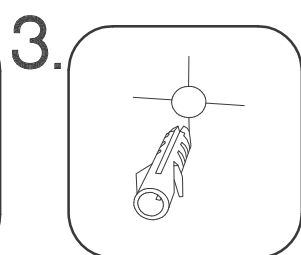
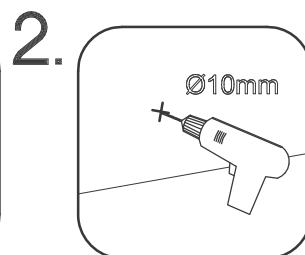
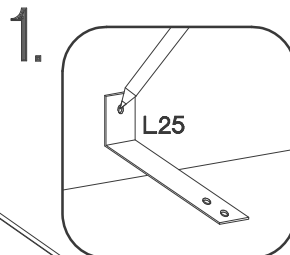
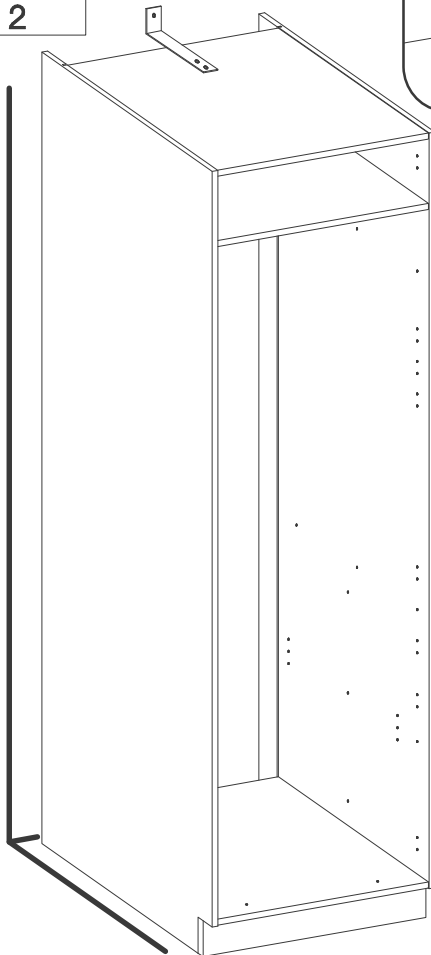

9

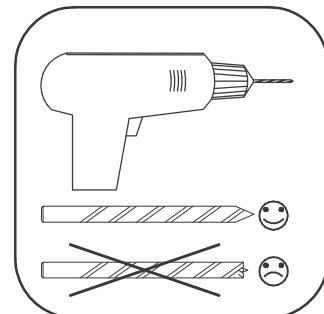
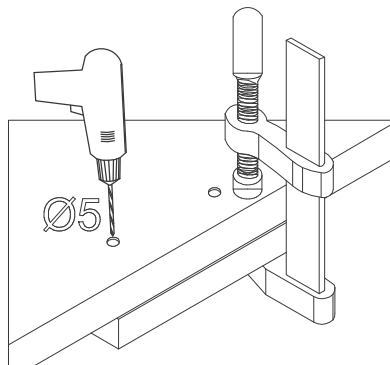
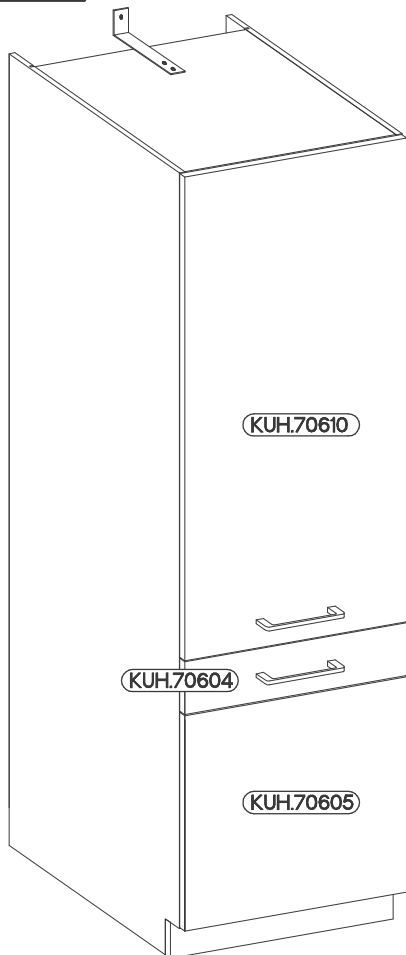

LEFT

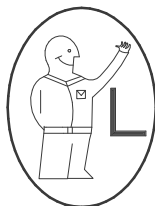
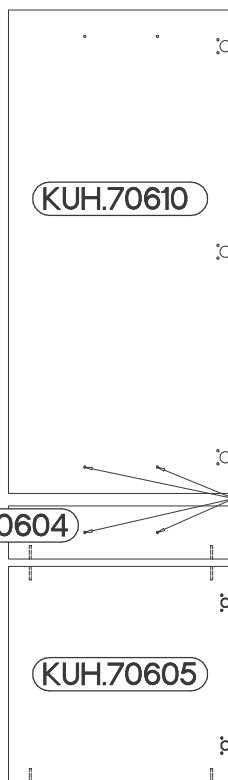
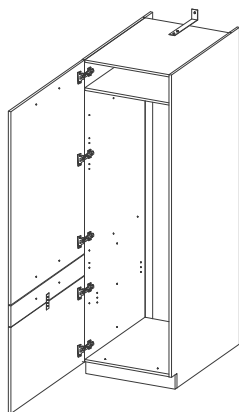

RIGHT

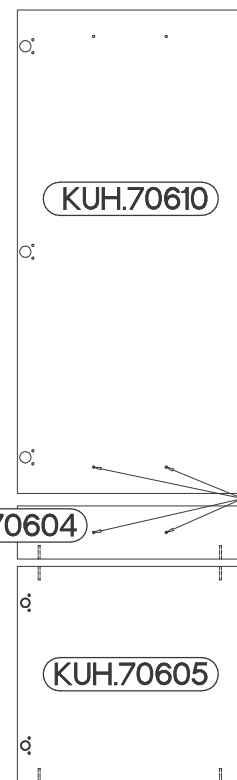
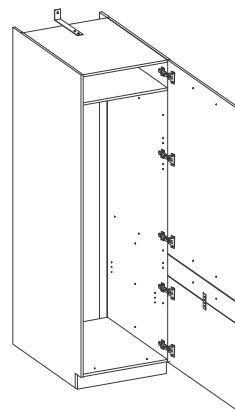

10

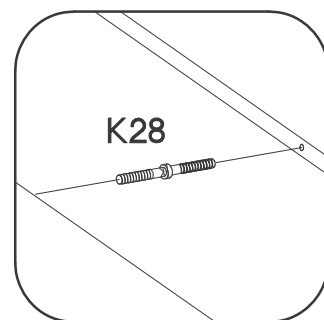
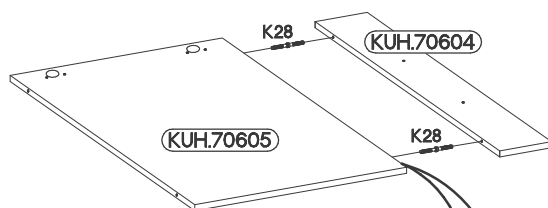
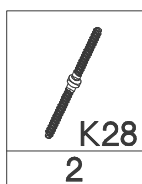

VARIANT HIGH GLOSS

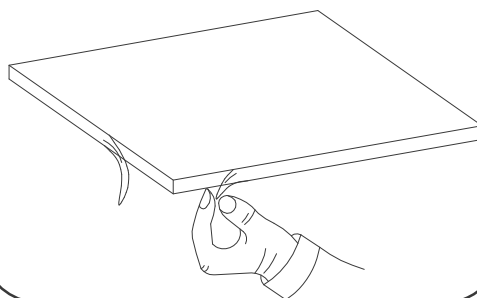

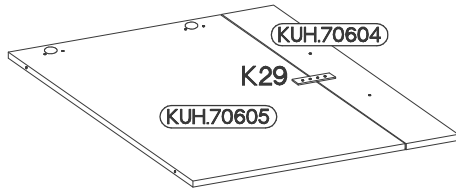
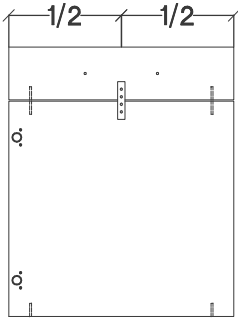
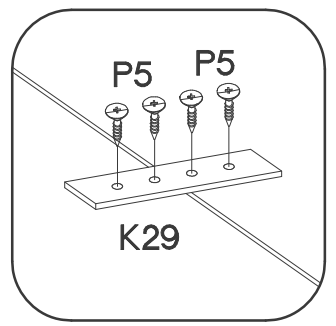
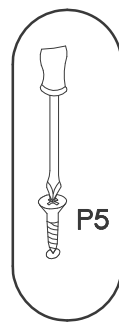

11

	±3.5x13mm
K29	P5
1	4



12

±35/0mm	±3.5x13mm
	
HG	P5
5	10

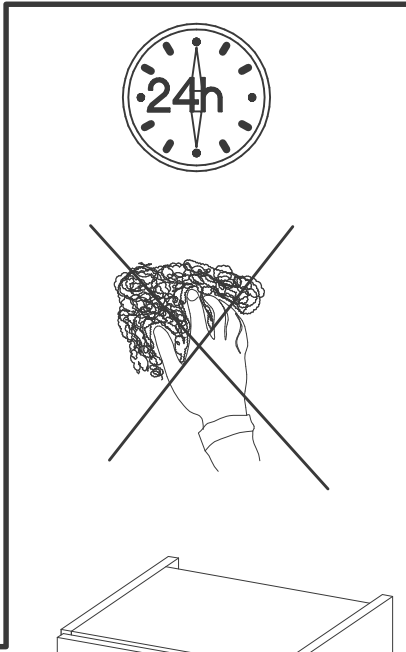
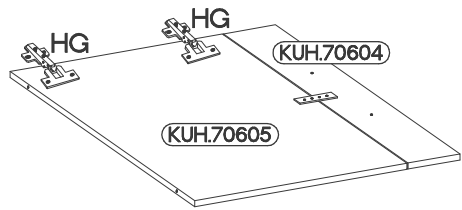
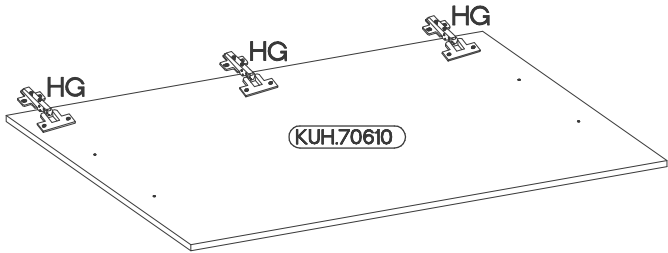
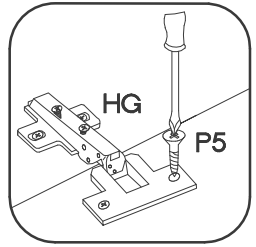
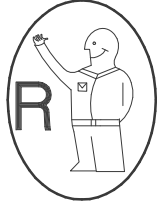

VARIANT HIGH GLOSS

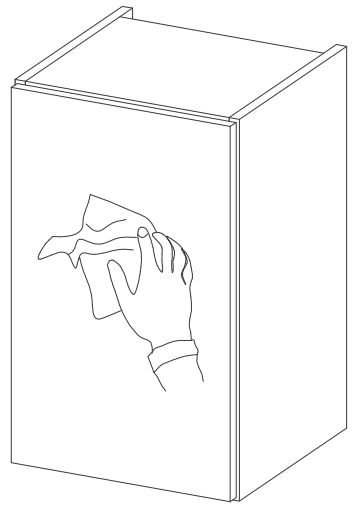
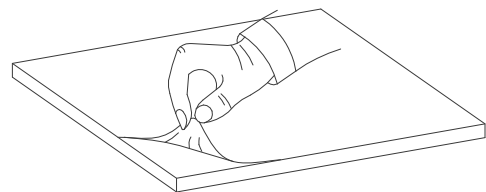
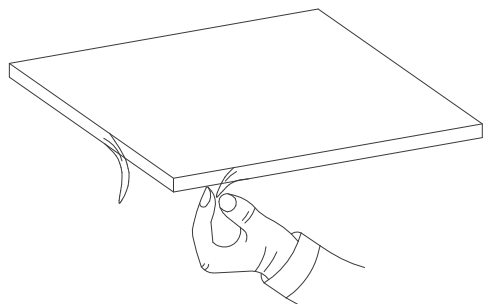

+4.0x30mm

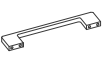
 R2 4	 S15 2
---	--

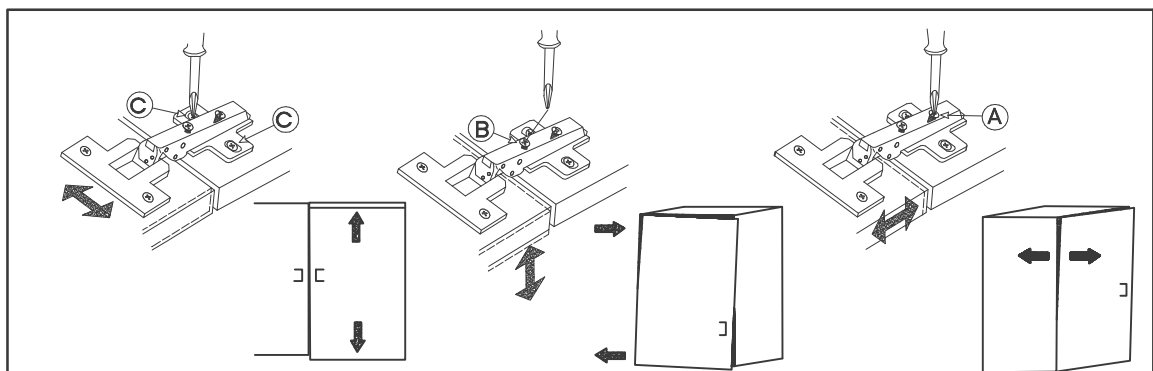
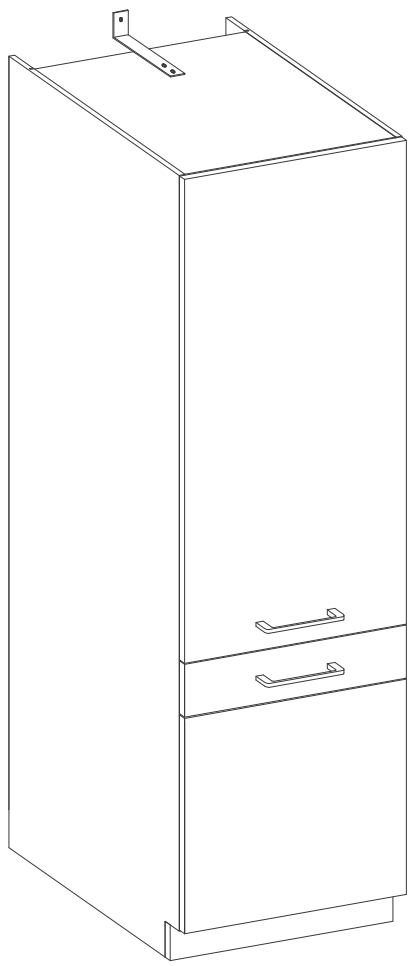
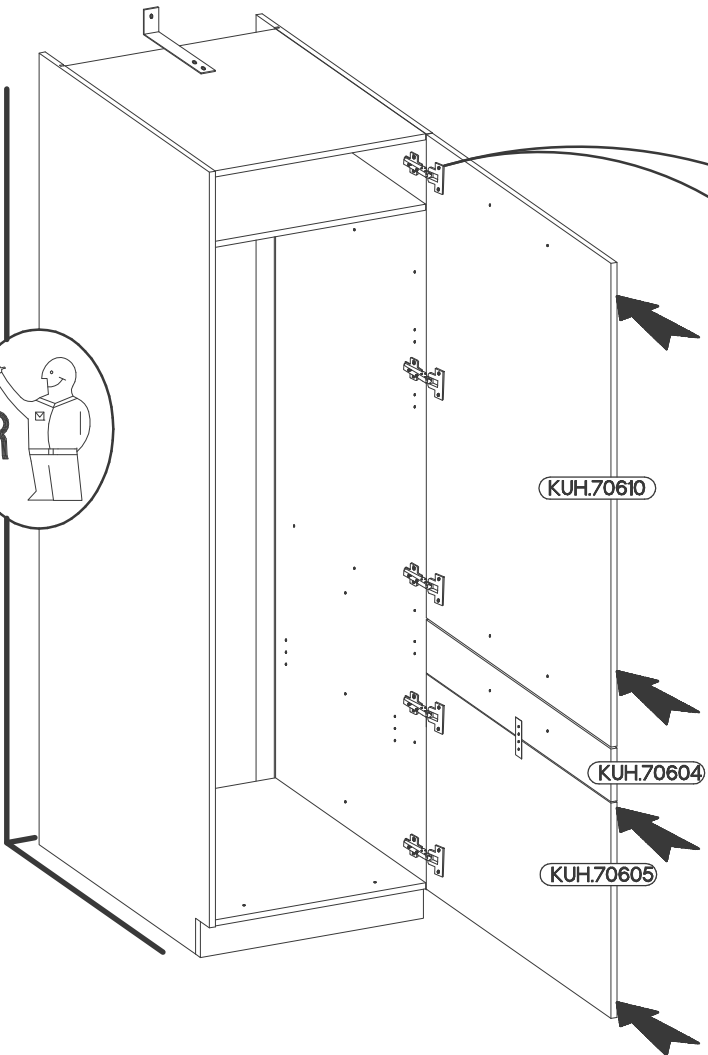
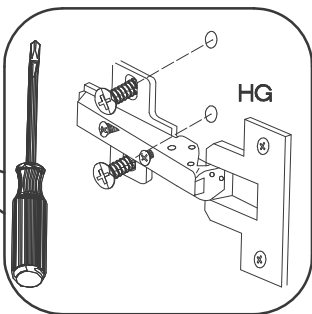
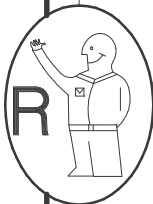
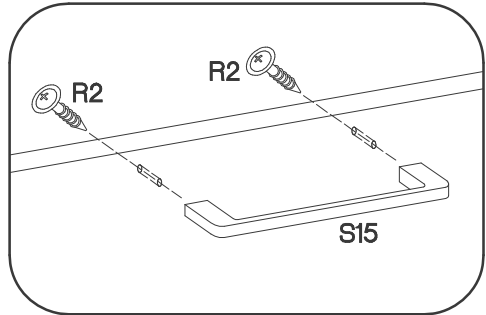

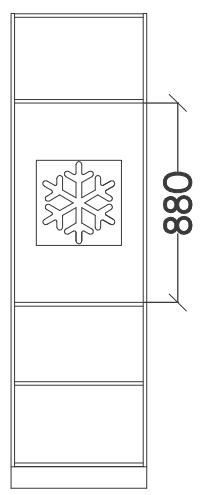
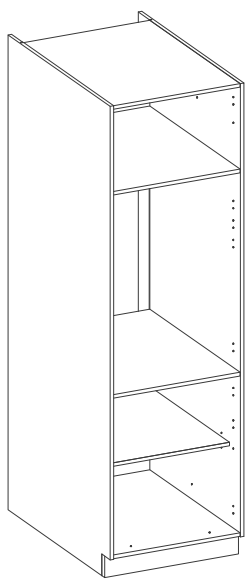

$\varnothing 8 \times 30 \text{mm}$ A	$6.5 \times 48 \times 16$ F2
8 L=20mm D2	4 $\varnothing 15 / 12 \text{mm}$ C
12	12

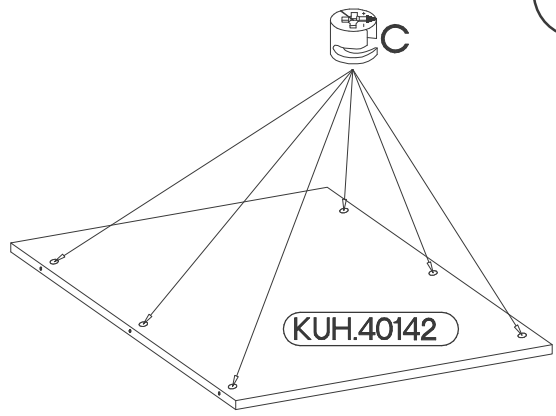
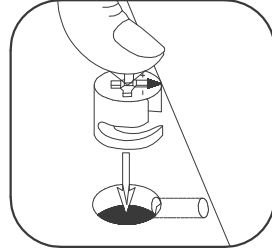
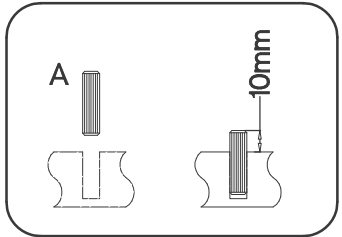
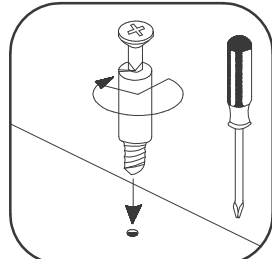
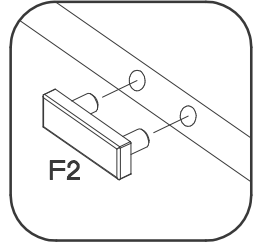
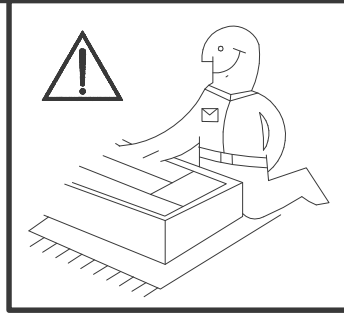

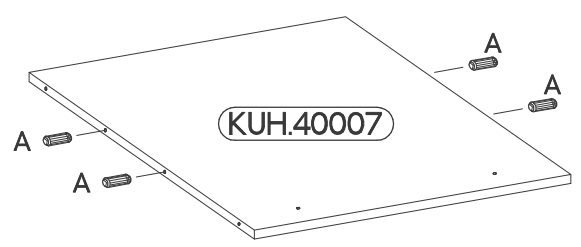
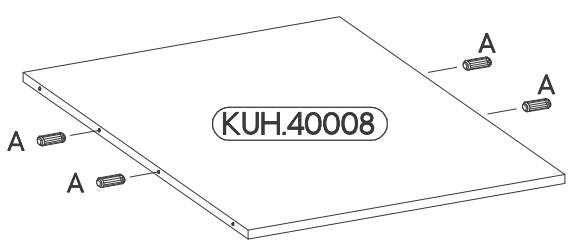
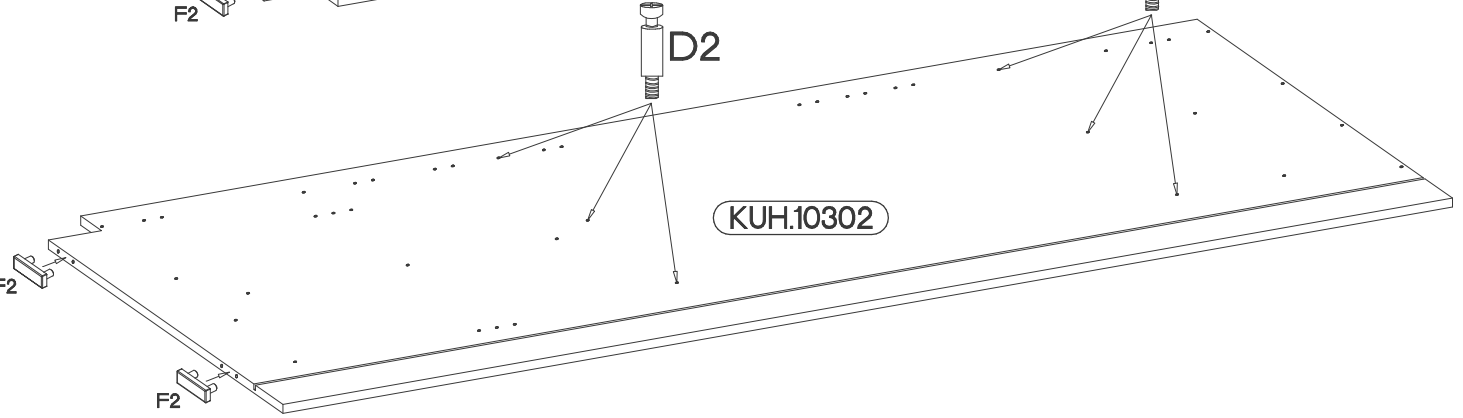
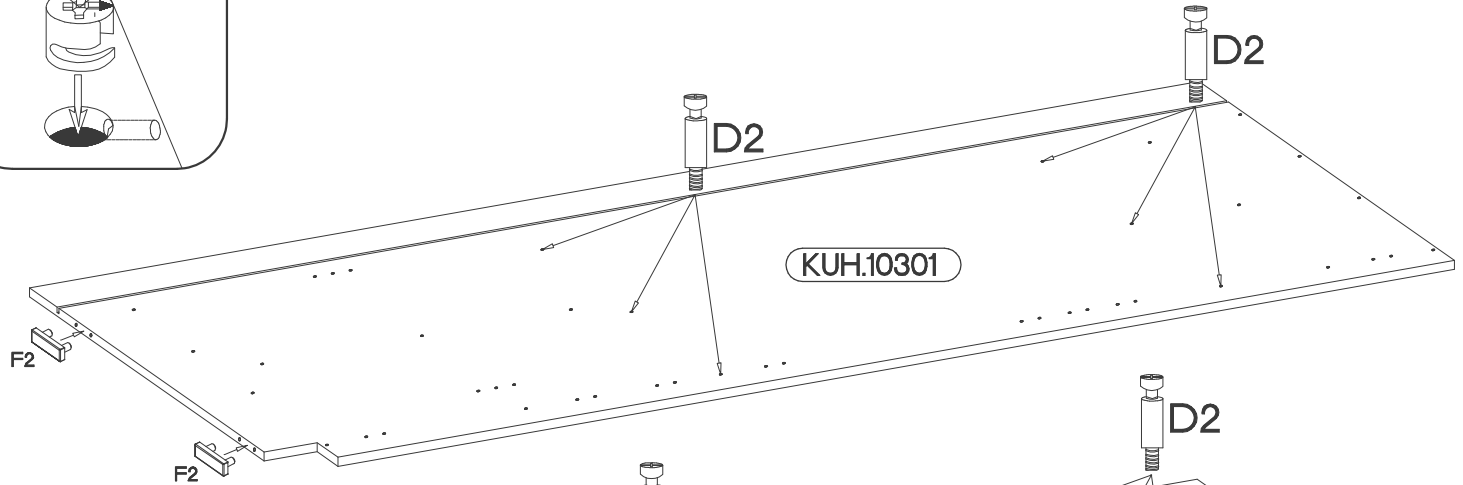

x2

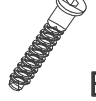

15

6,4 x 50mm

 B	 O	 E1
4	1	4

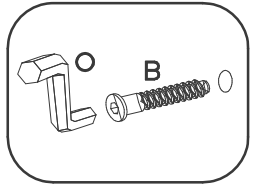
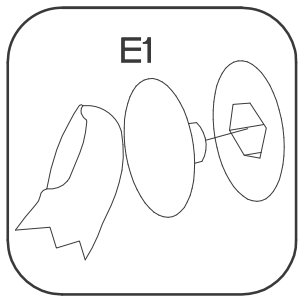
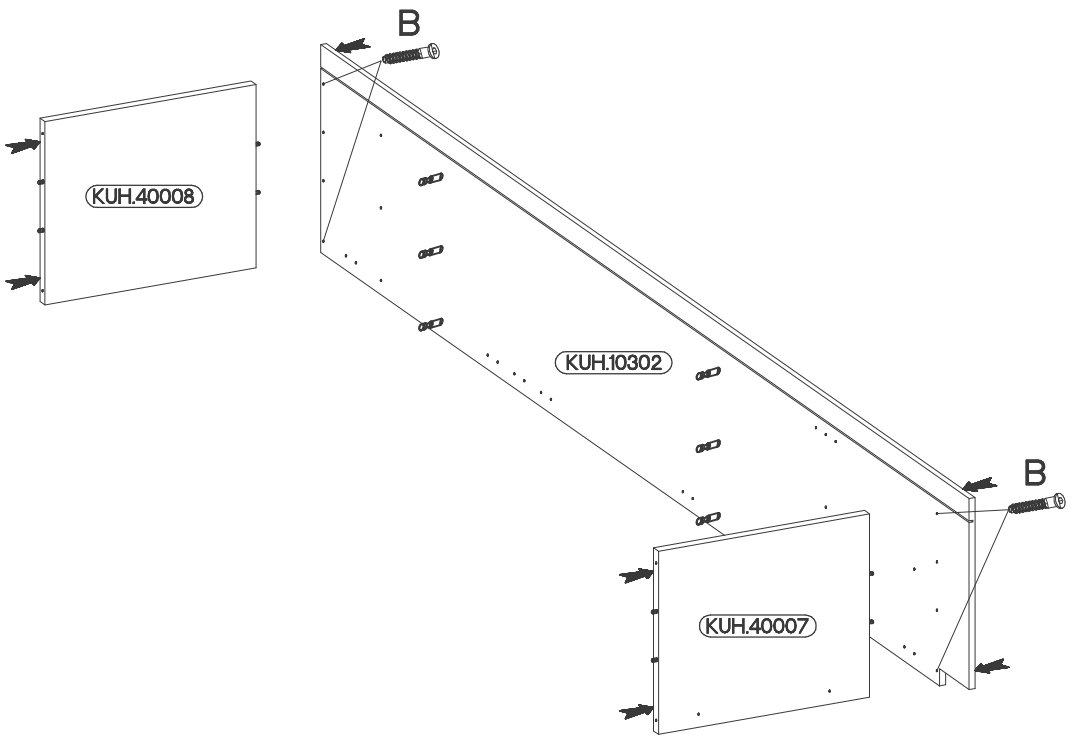
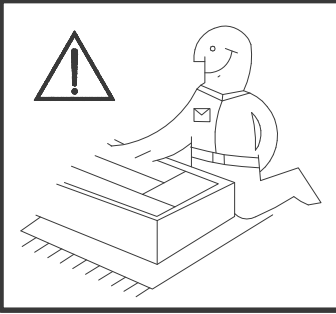



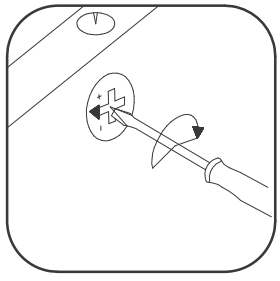
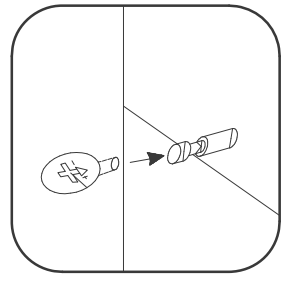
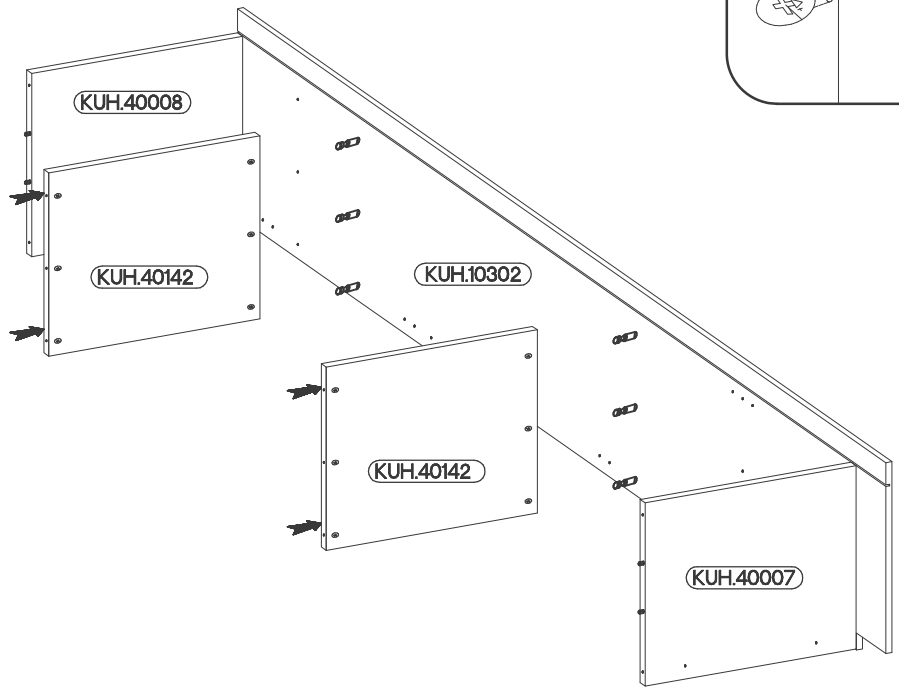

16





17

6,4 x 50mm

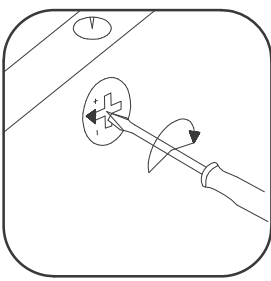
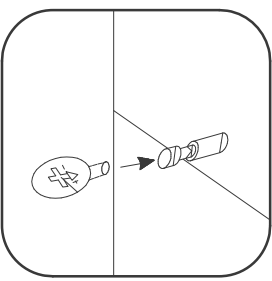
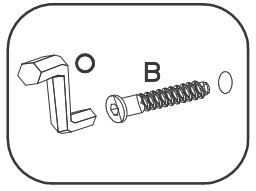
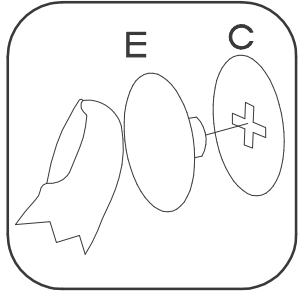
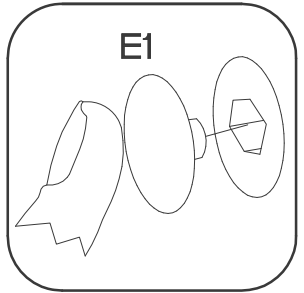
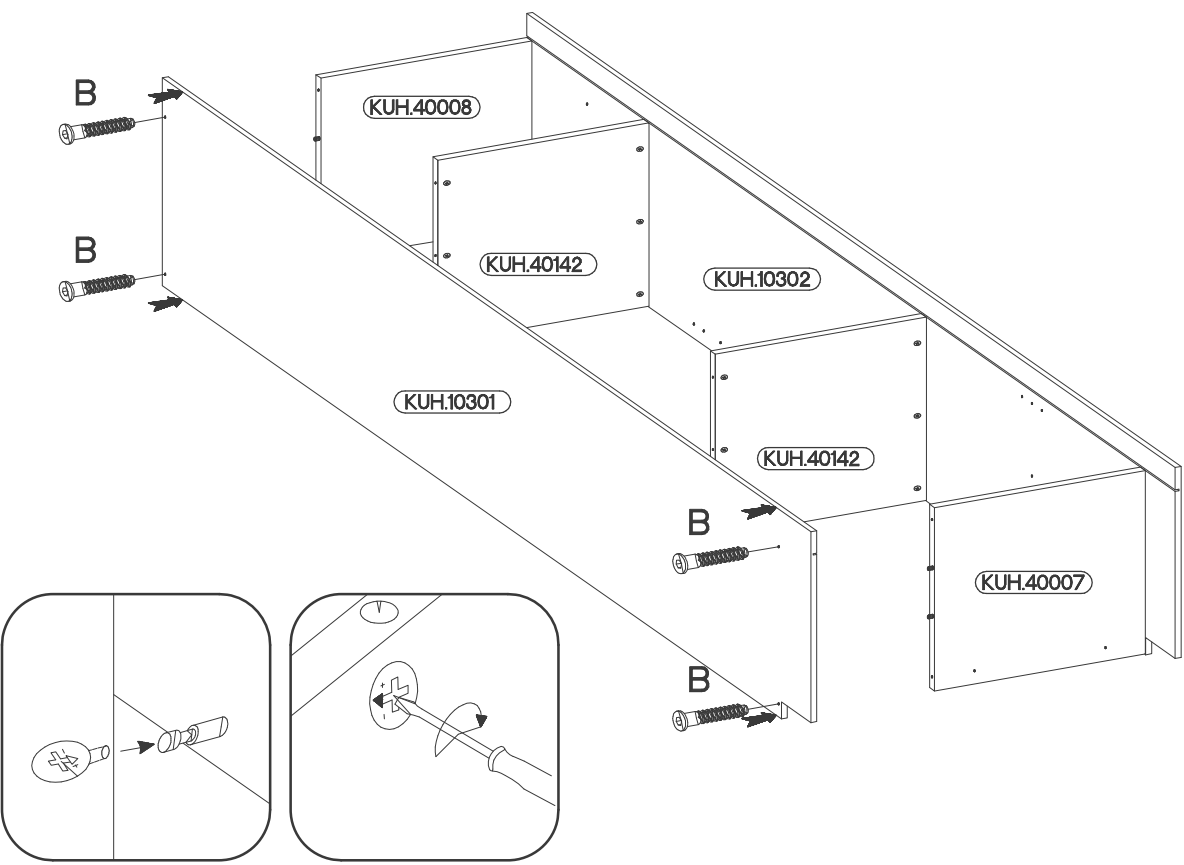
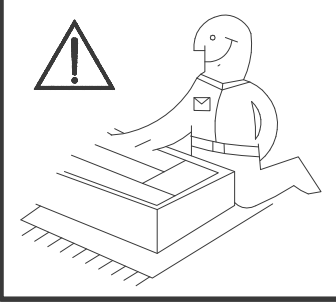
			
B	O	E1	E
4	1	4	12

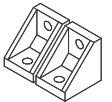

18

	
T4	P1
4	16

±4.0x16mm

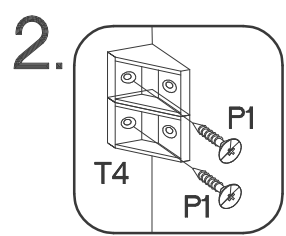
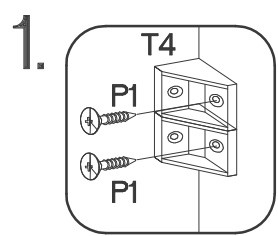
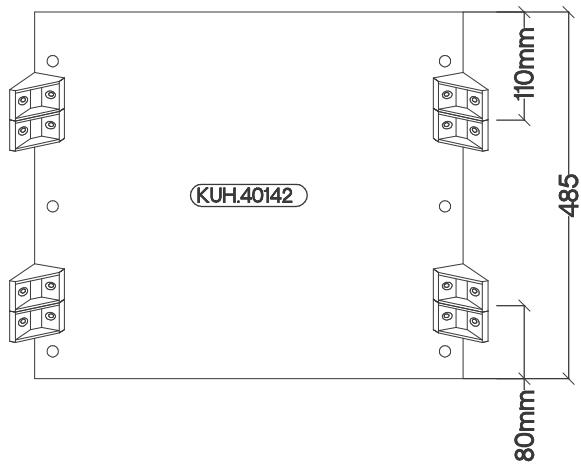
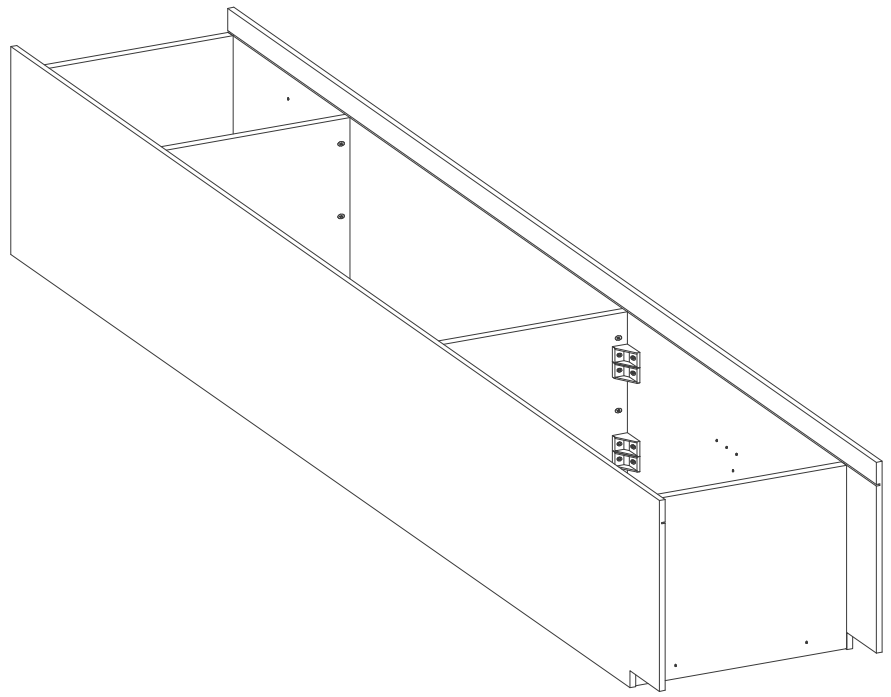

±3.0x20mm
P7
15-20

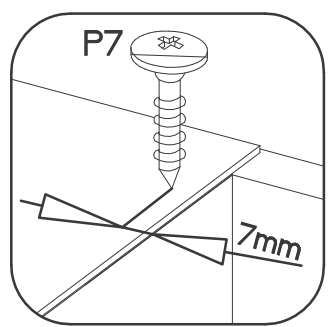
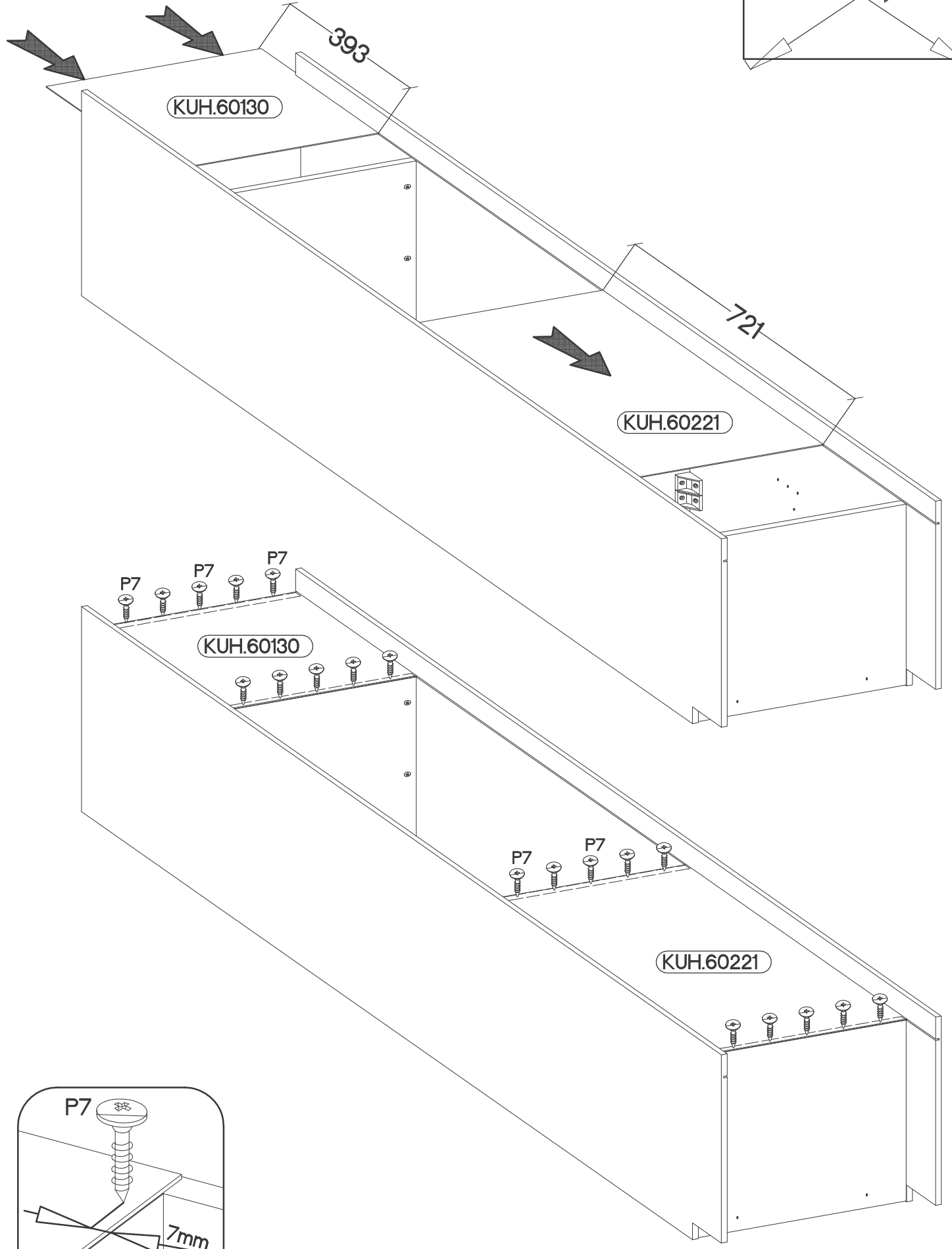
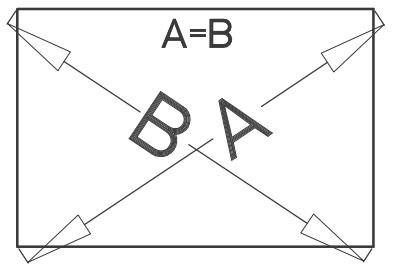

20

±4.0x45mm



P4

2



E9

2

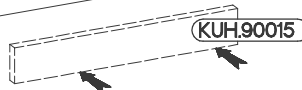
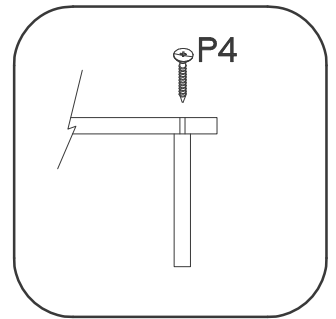
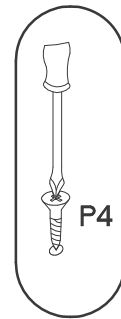
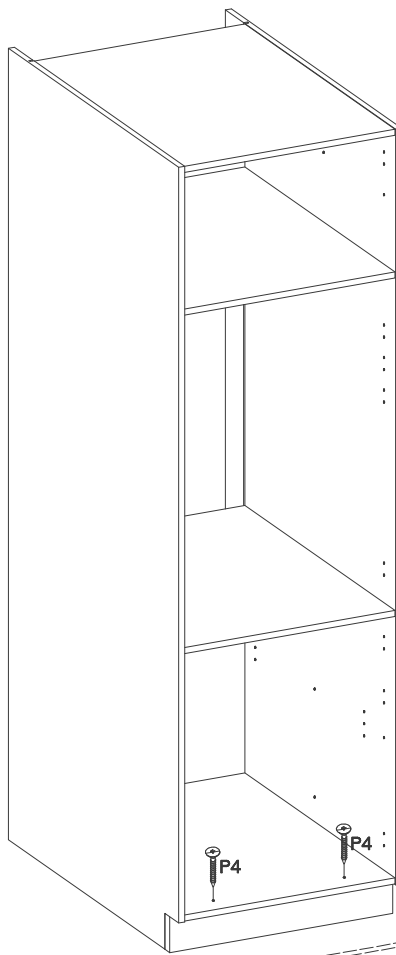

21



±5/19mm

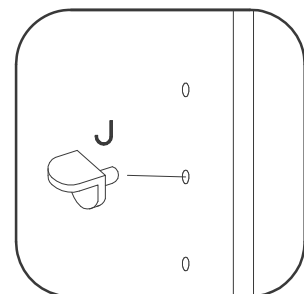
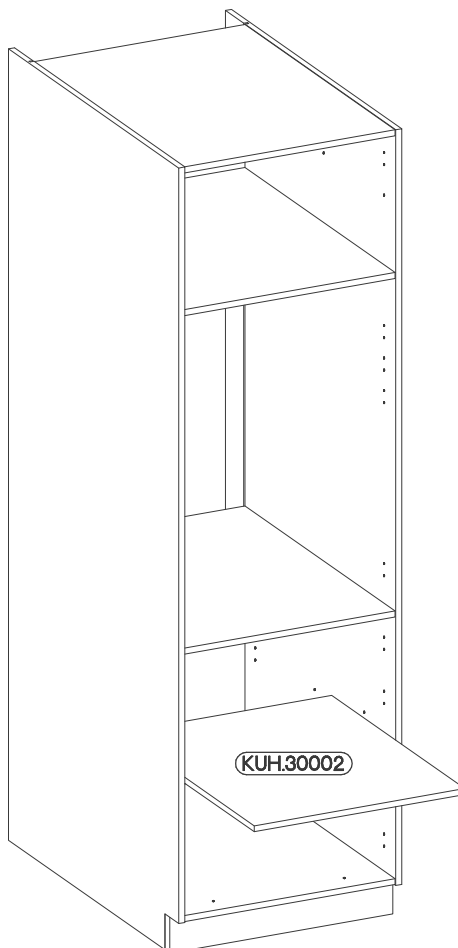

J

4

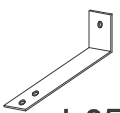

 L25 1	 3.5x13mm P5 2
--	---

1.

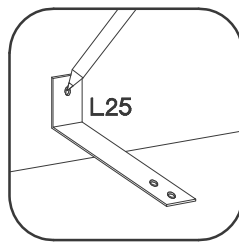

2.

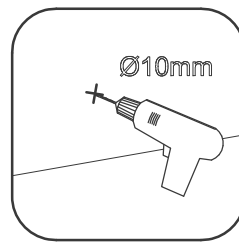

3.

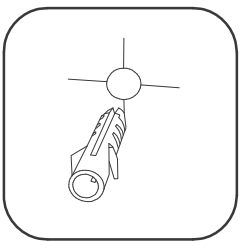

4.

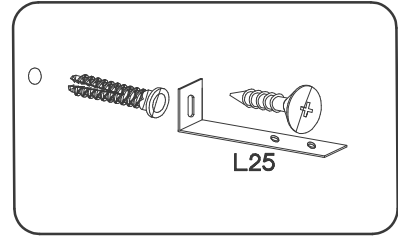

5.

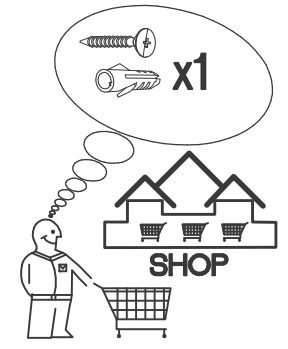
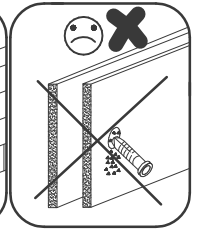
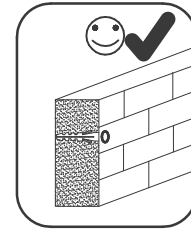
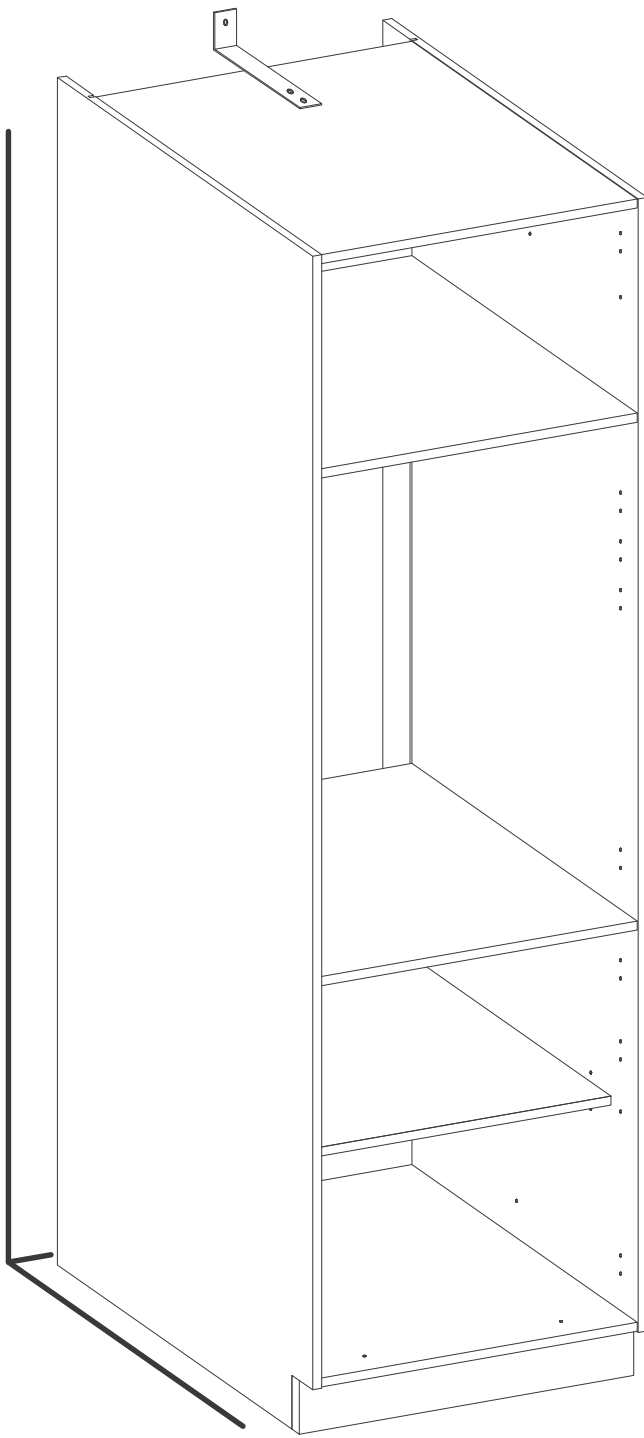
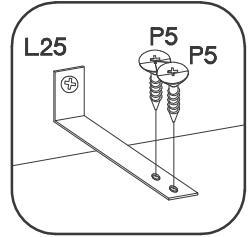

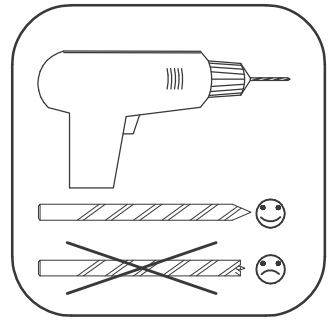
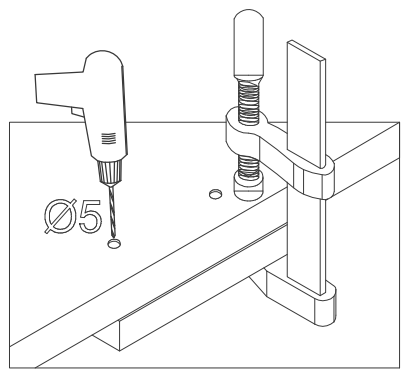
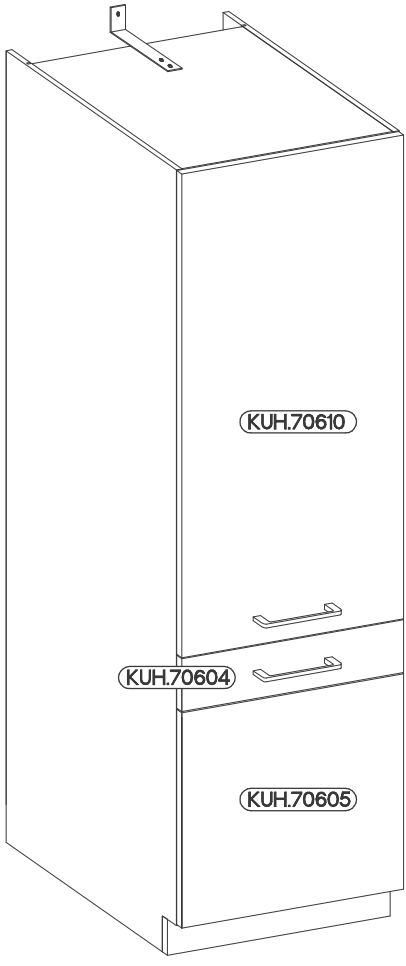

LEFT

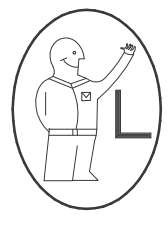
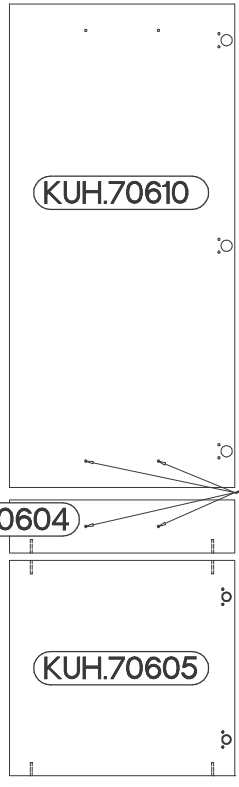
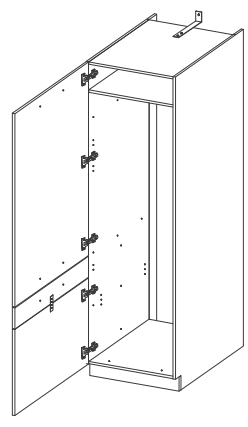

RIGHT

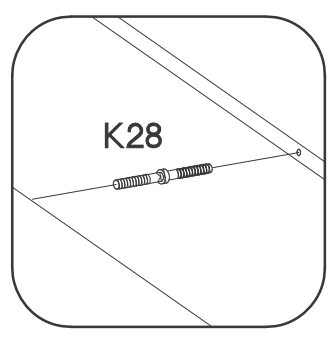
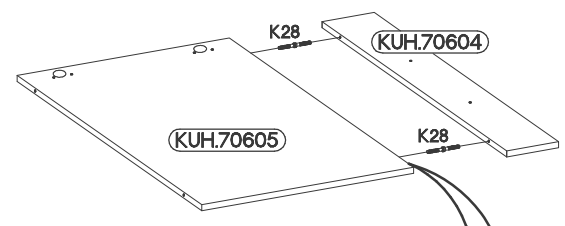
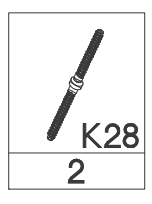
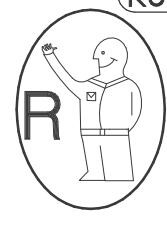
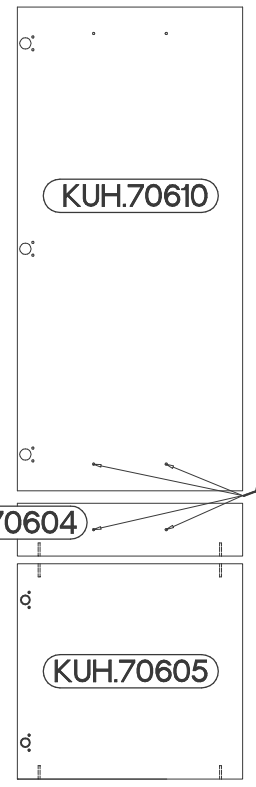
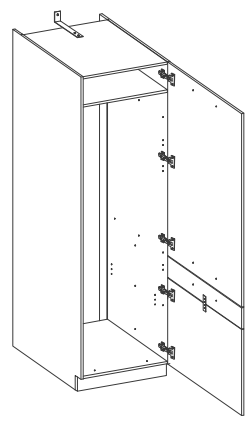

VARIANT HIGH GLOSS

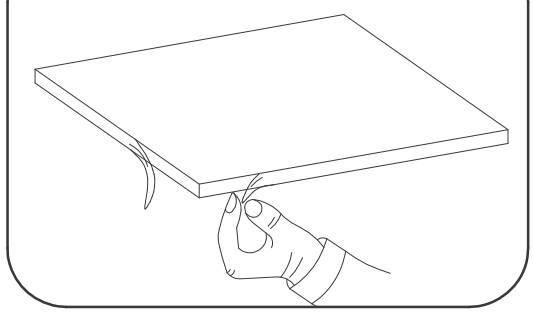

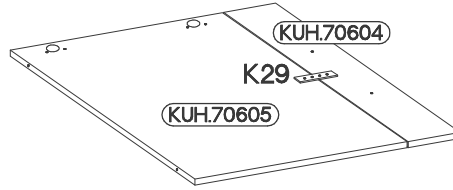
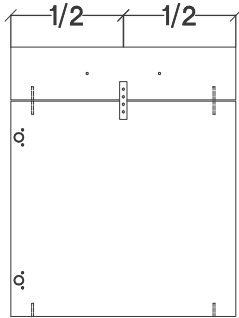
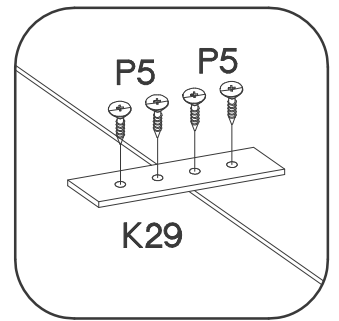
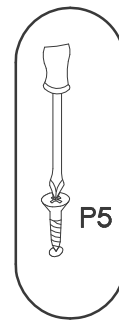

25

	±3.5x13mm
K29	P5
1	4



26

±35/0mm	±3.5x13mm
	
HG	P5
5	10

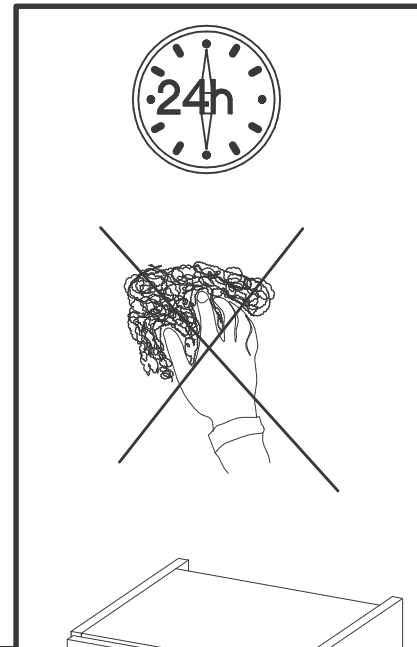
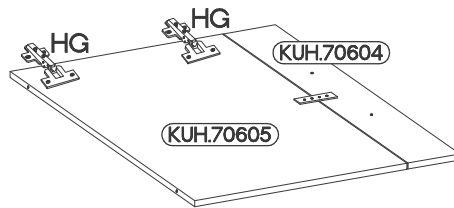
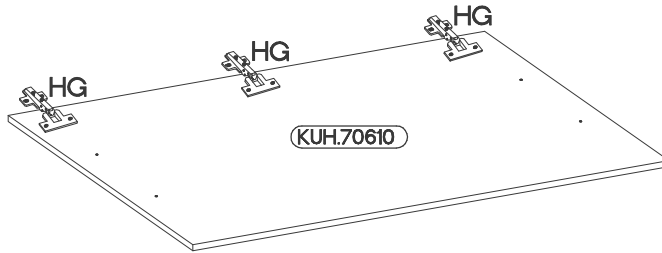
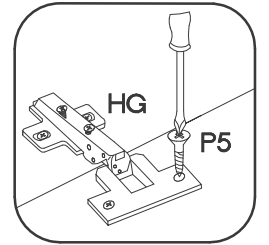
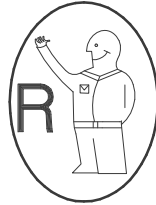

VARIANT HIGH GLOSS

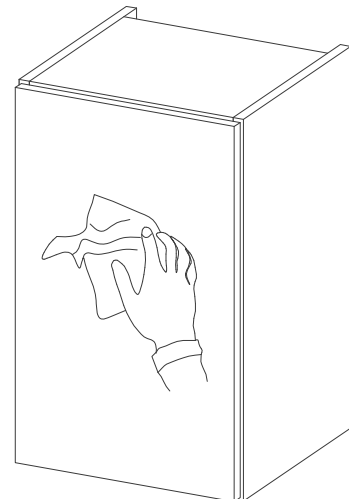
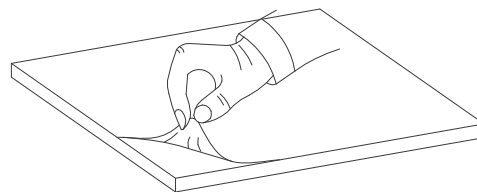
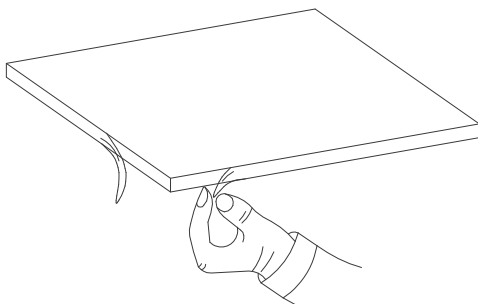

+4.0x30mm



R2

4



S15

2

