

Ø10mm

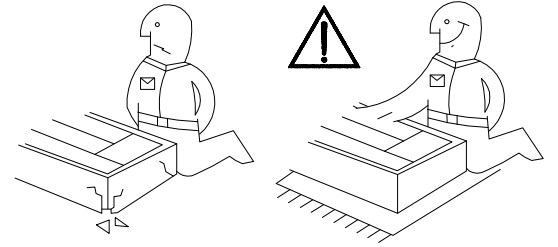

60 DP/DK-2100

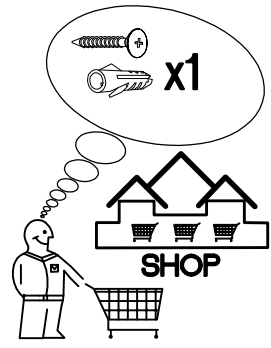
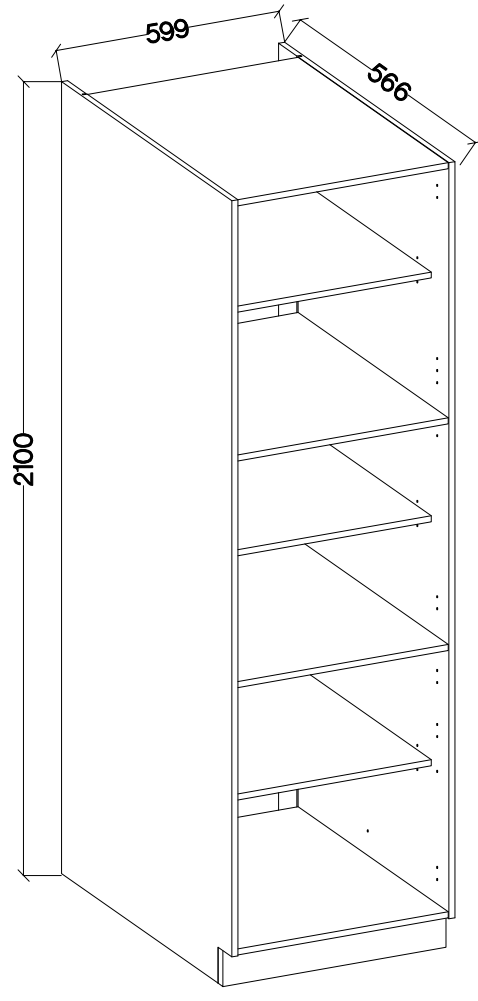
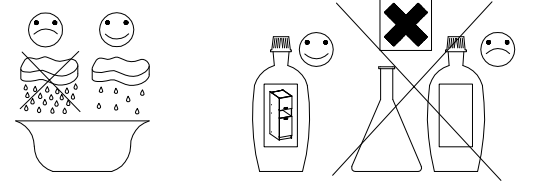

max. 10kg  
 KUH.30002  
 KUH.40007  
 KUH.40008

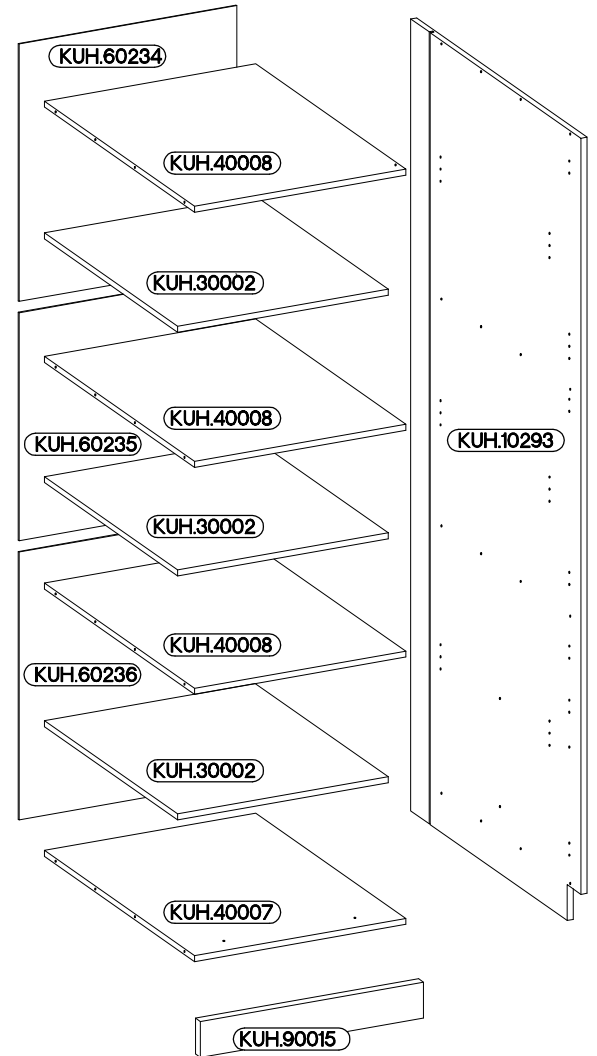
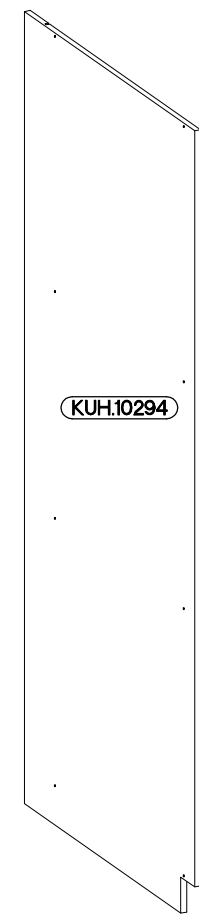
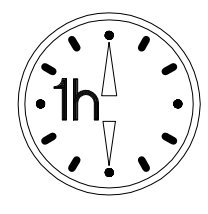

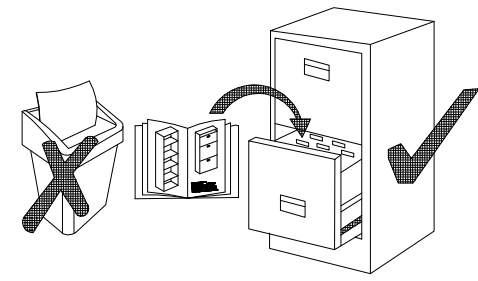

<b>A</b> 16	<b>B</b> 16	<b>E1</b> 16	<b>E9</b> 2	<b>F2</b> 4	<b>HG</b> 5	<b>J</b> 12
<b>L2</b> 8	<b>L25</b> 1	<b>O</b> 1	<b>P4</b> 2	<b>P5</b> 12	<b>P7</b> 15-20	<b>S23</b> 2
			<b>P4</b> 2	<b>P5</b> 12	<b>P7</b> 15-20	<b>U</b> 4



ISM-KUH-01099

1

6.5x48x16	+8x30mm
	
F2	A
4	16

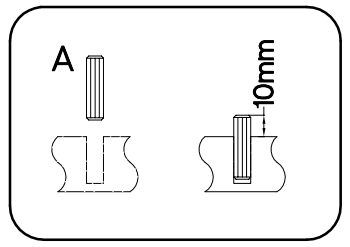
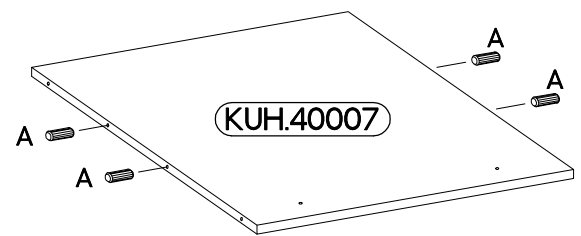
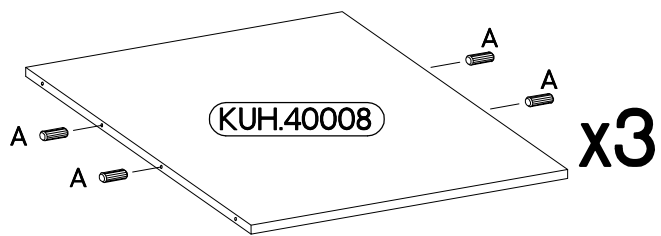
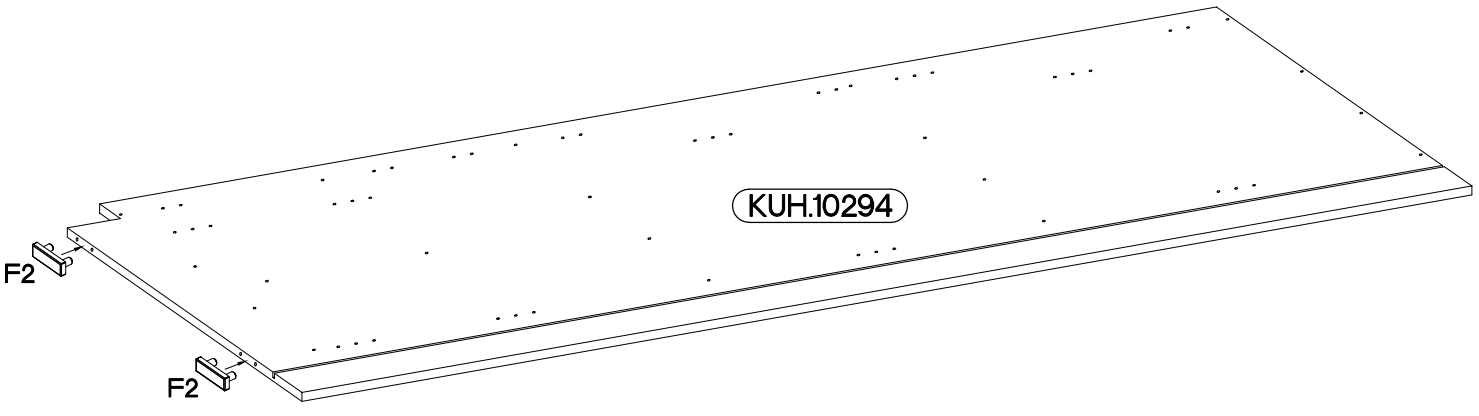
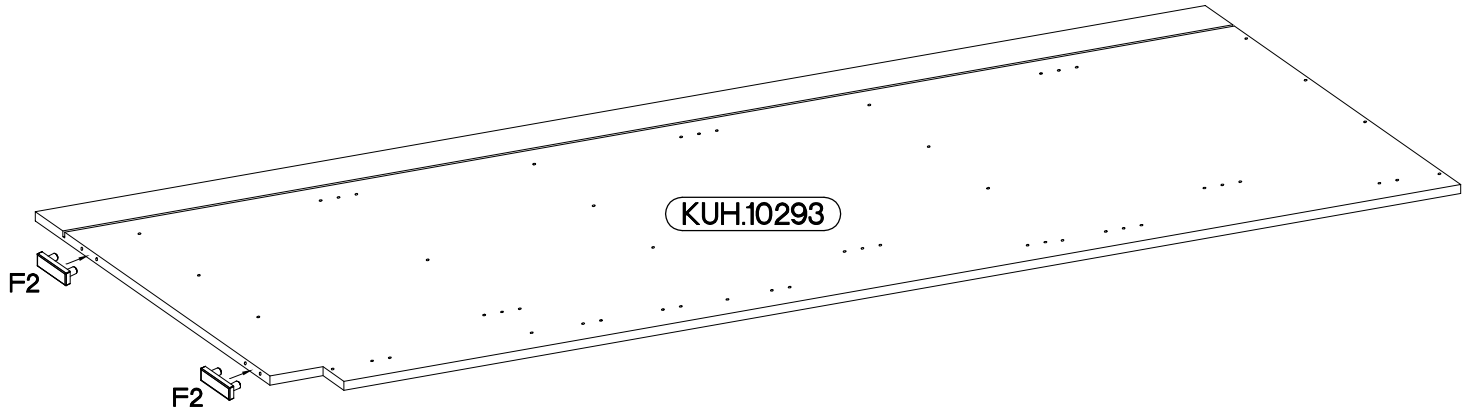
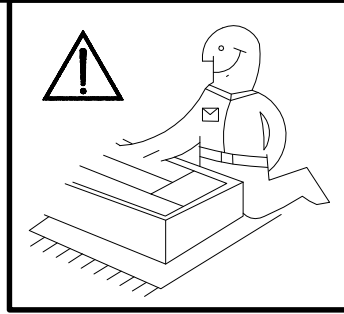
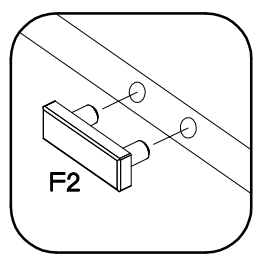

# 2

6,4 x 50mm

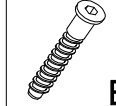

B

8

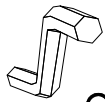

O

1



E1

8

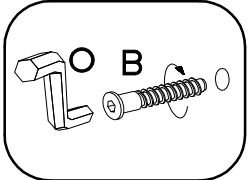
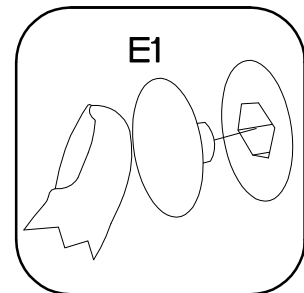
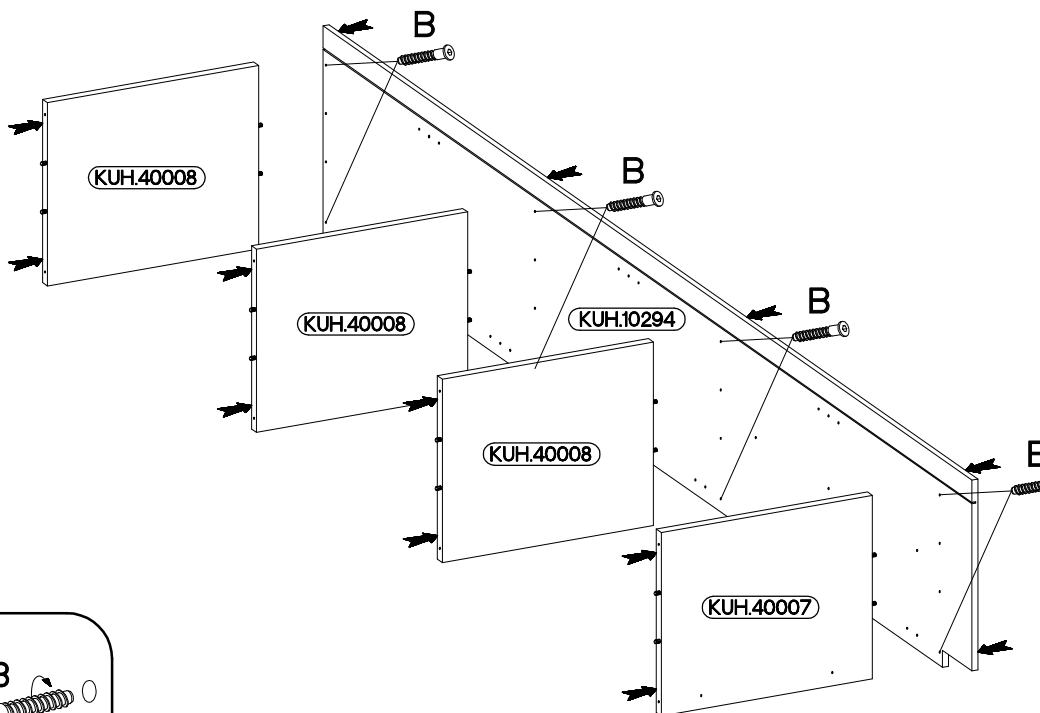
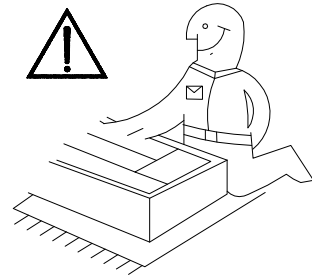

# 3

6,4 x 50mm

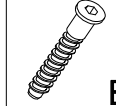

B

8

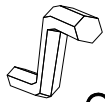

O

1



E1

8

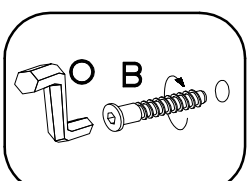
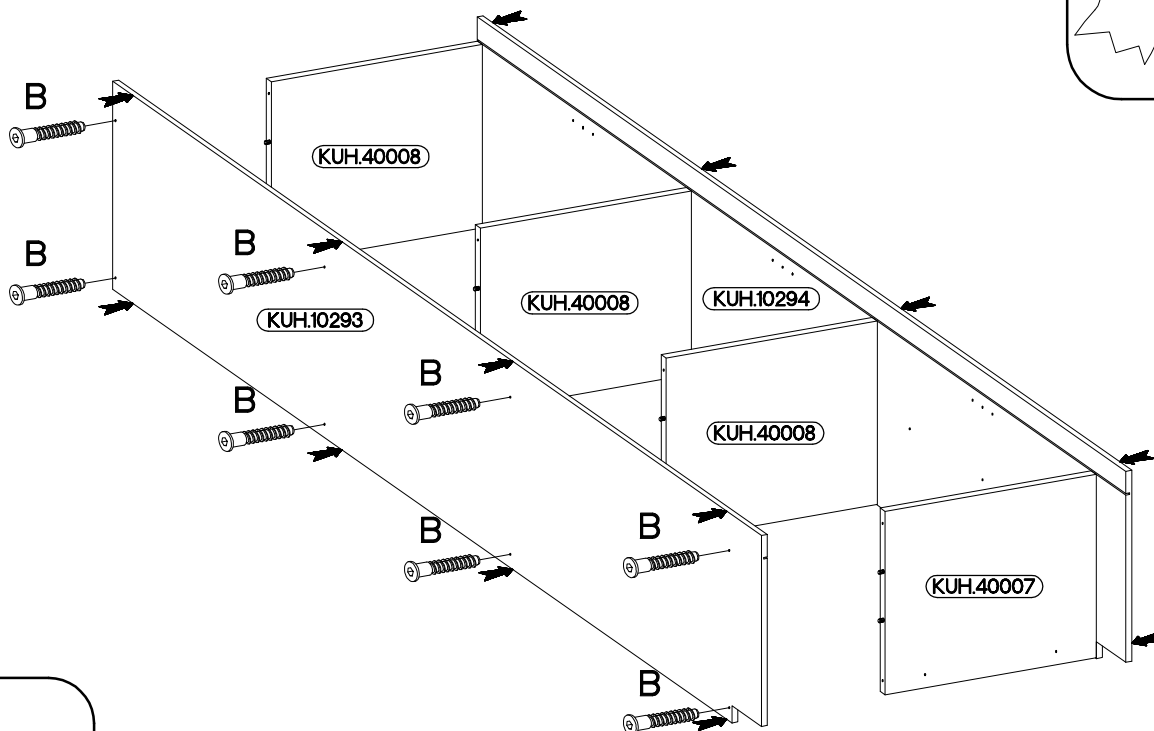
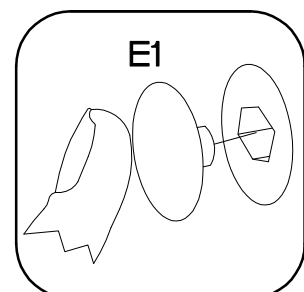

4

60 DP-2100 2F

60 DPS-2100 1F 3S

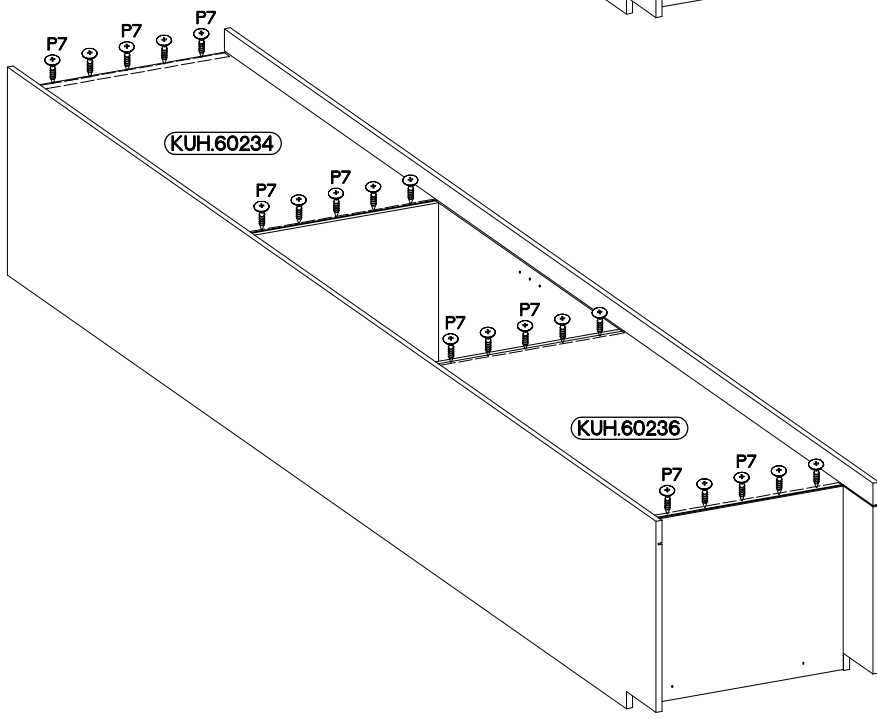
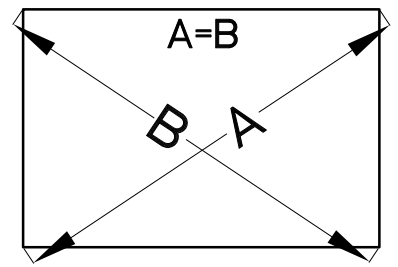
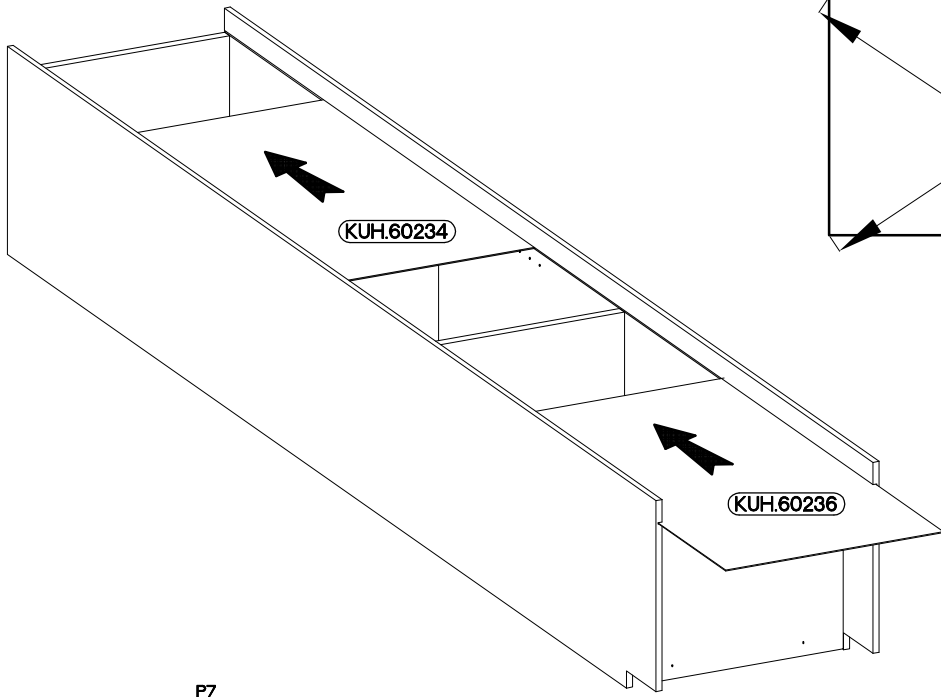
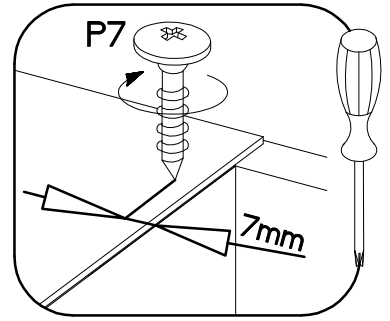
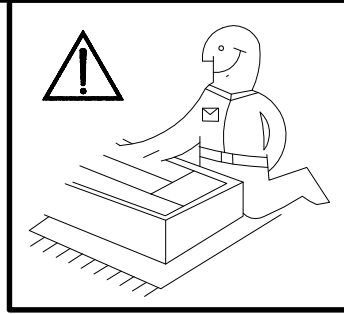
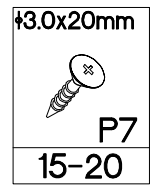
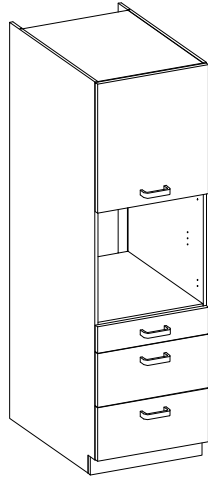
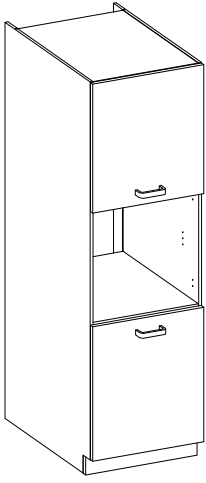

5

60 DK-2100 2F

60 DKS-2100 1F 3S

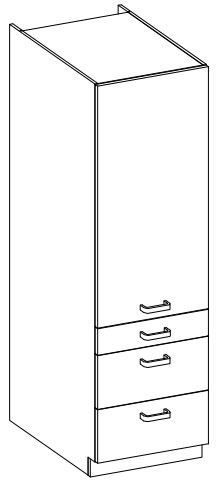
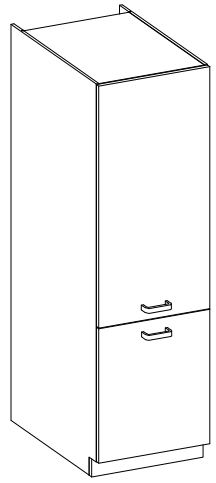

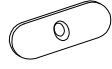
±3.0x20mm  P7 15-20	 L2 8
--	--

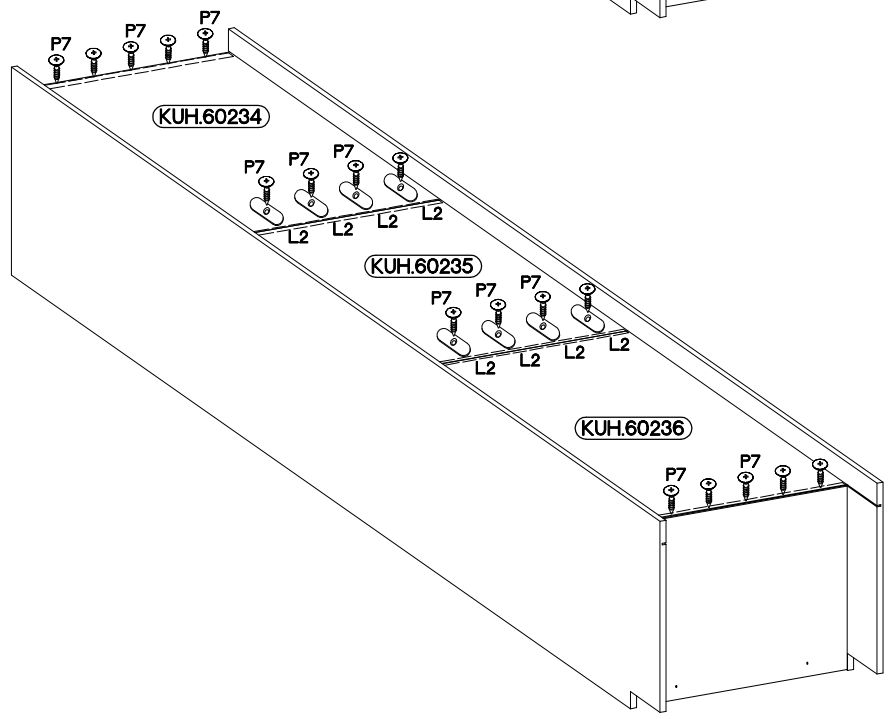
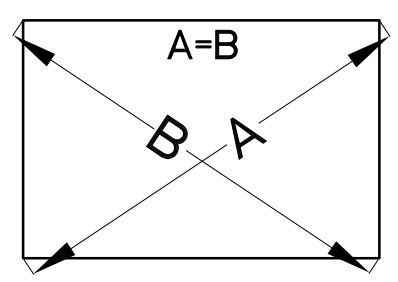
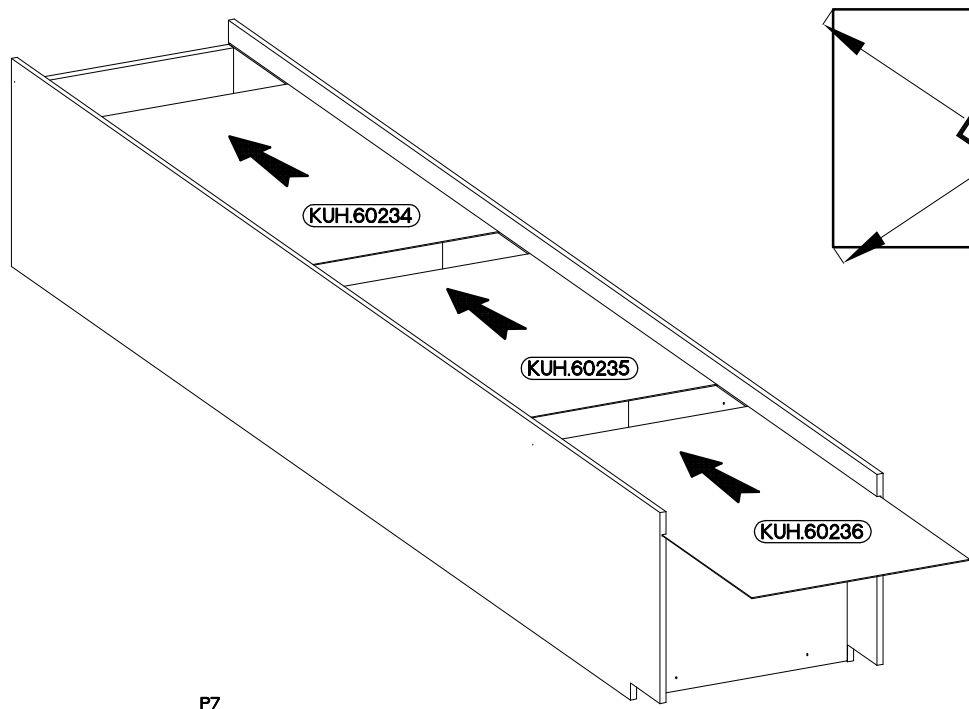
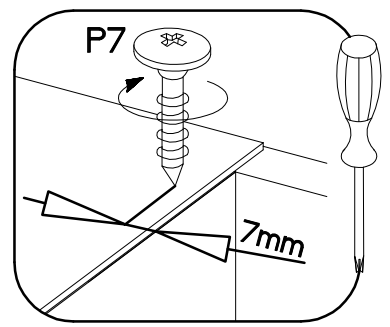
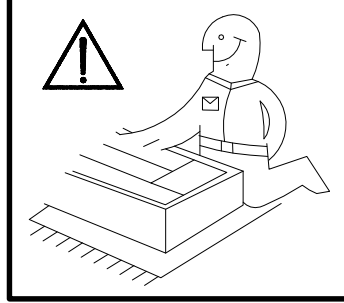

6

±4.0x45mm



P4

2



E9

2

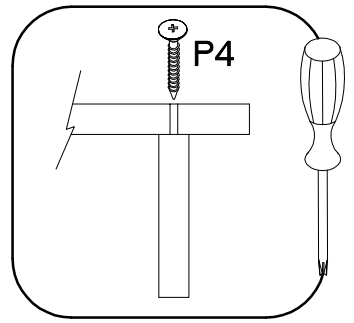
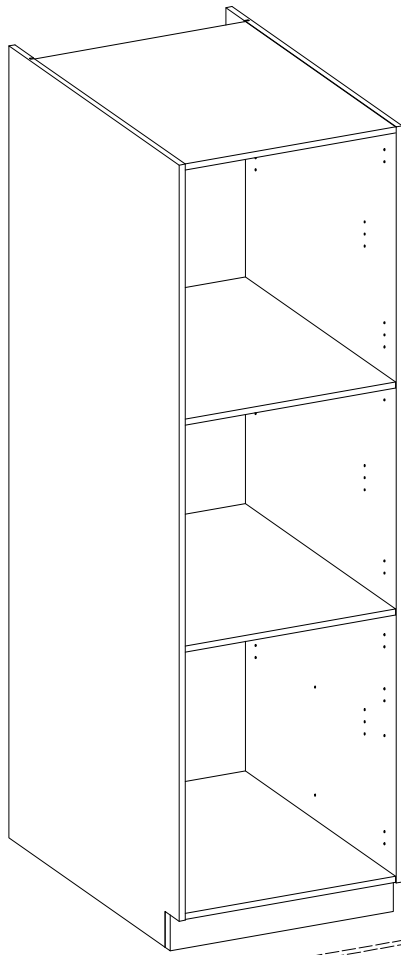

(KUH.90015)

7

±5/19mm



J

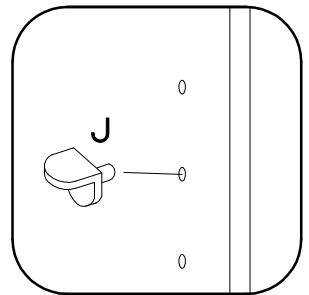
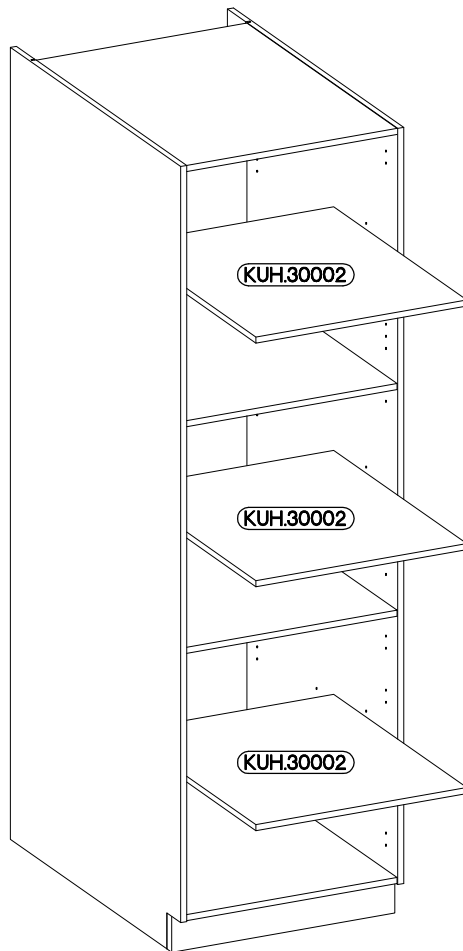

12



(KUH.30002)

(KUH.30002)

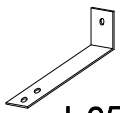
(KUH.30002)

 L25 1	$\pm 3.5 \times 13 \text{mm}$  P5 2
--	--

