

Ø10mm

60 G-90 1F

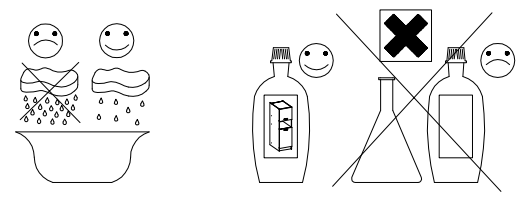

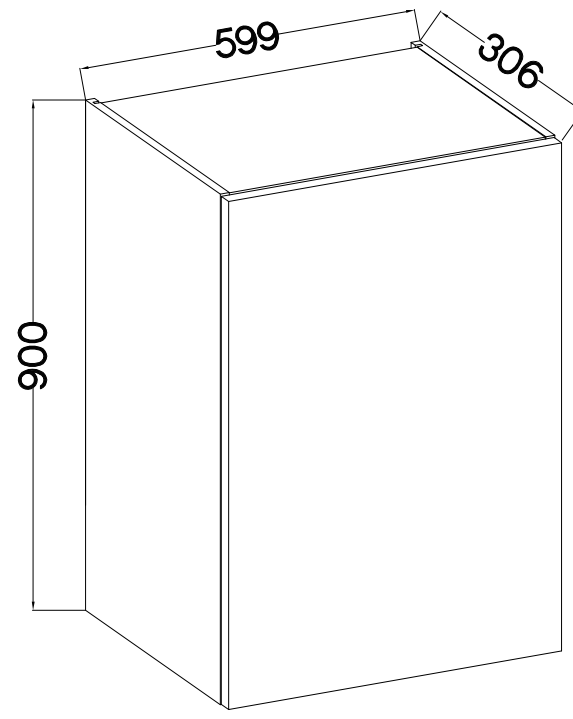
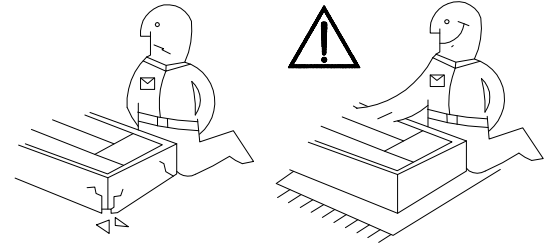
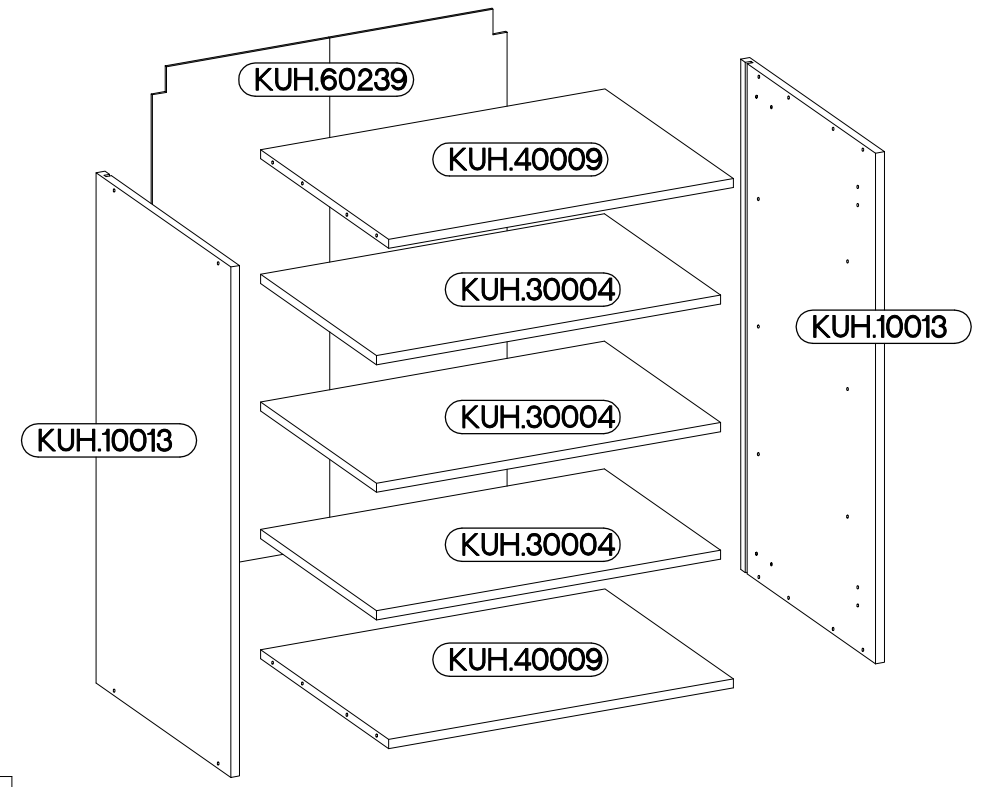
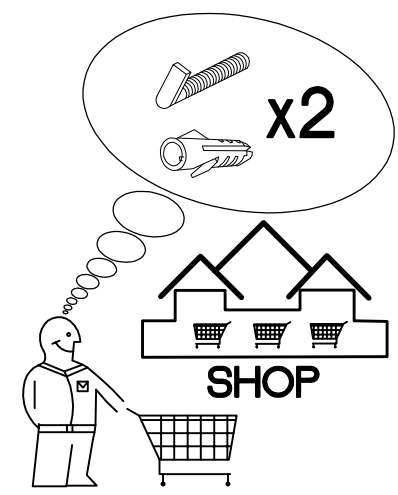
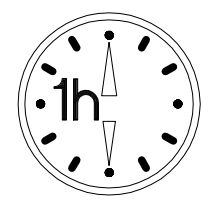

KUH.30004
KUH.40009

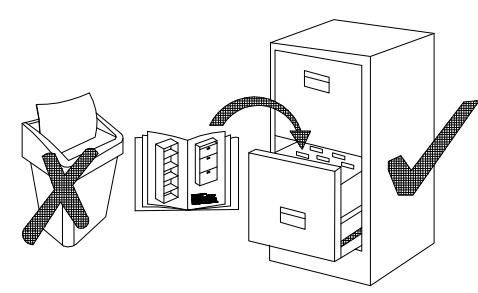

 †8x30mm A 8	 6,4 x 50mm B 8	 E1 8	 †35/0mm HG 2
 †5/19mm J 12	 K 2	 O 1	 †3.5x13mm P5 4
			 †3.0x20mm P7 8-10
			 †4.0x30mm P8 4



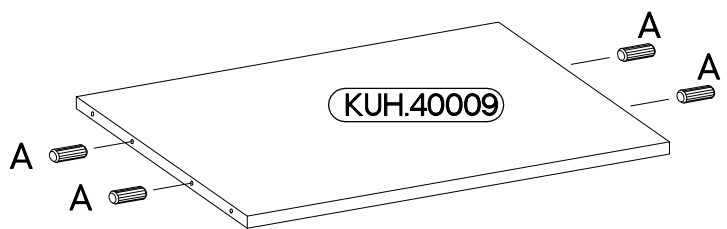
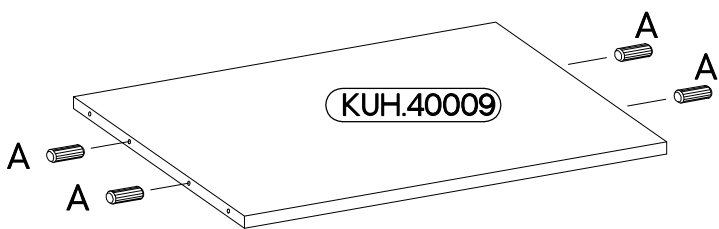
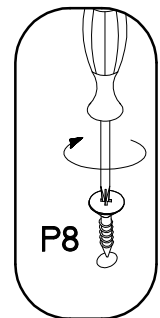
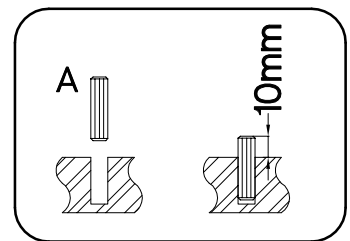
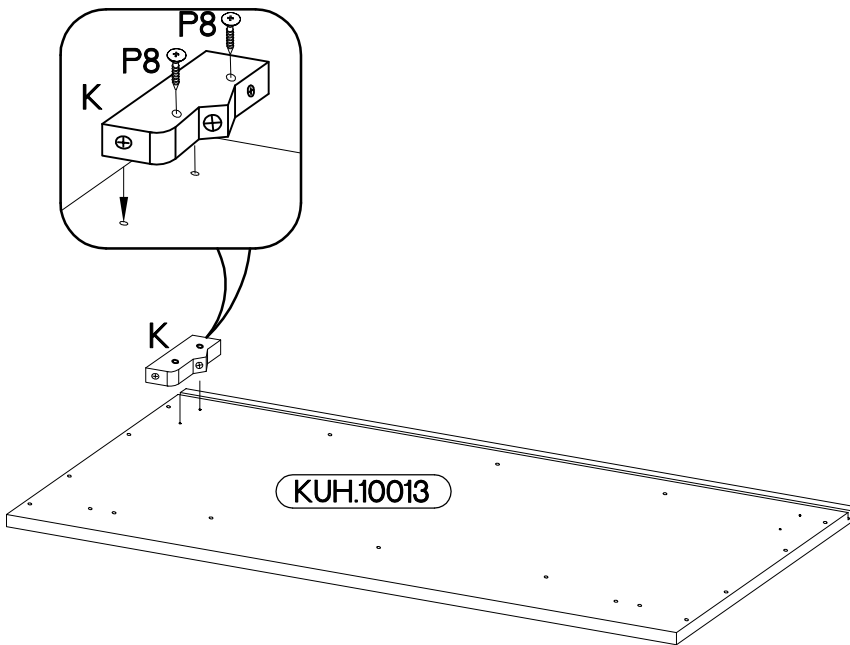
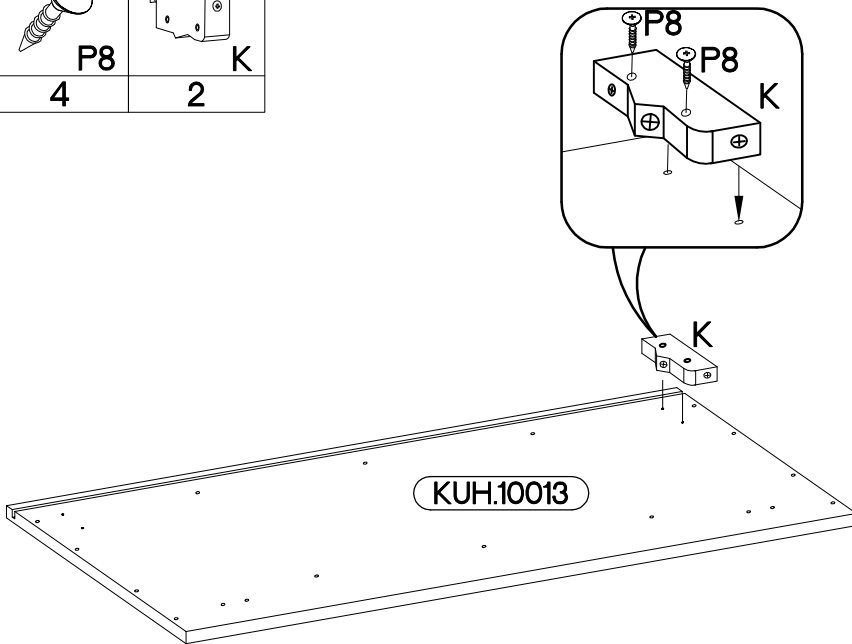
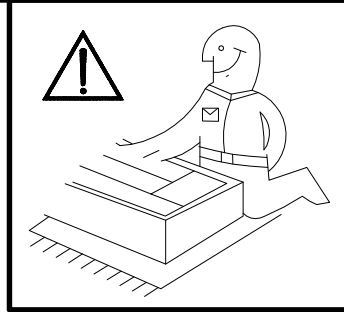

ISM-KUH-01130

 ø8x30mm A	 ø4.0x30mm P8	 K
8	4	2



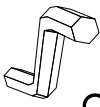

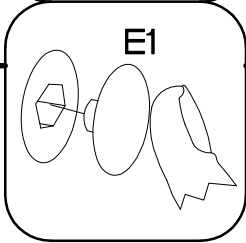
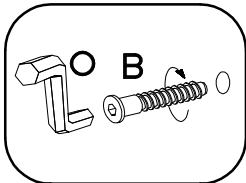
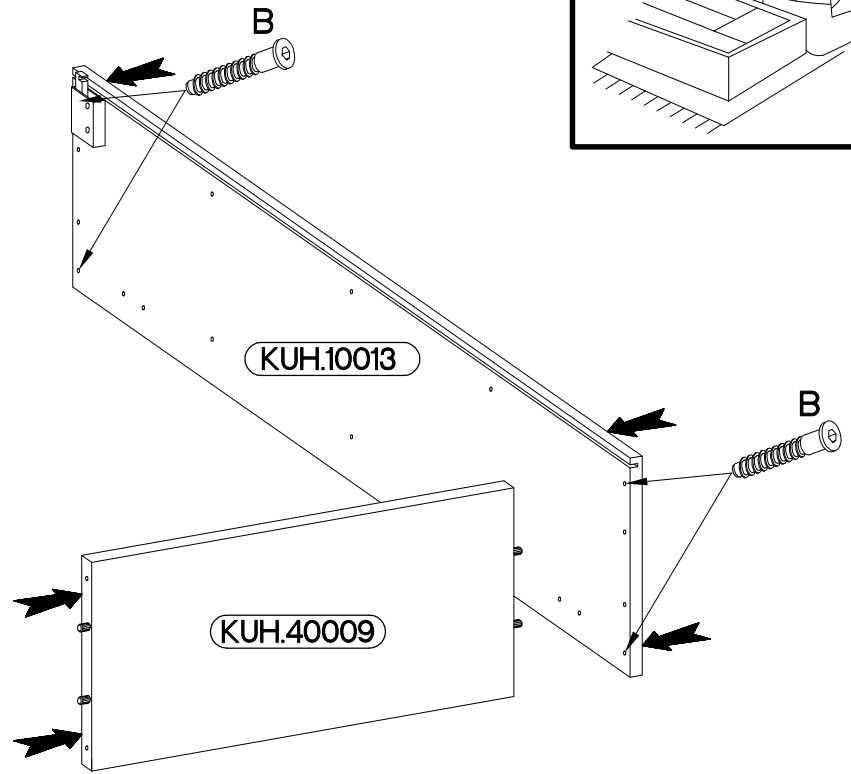
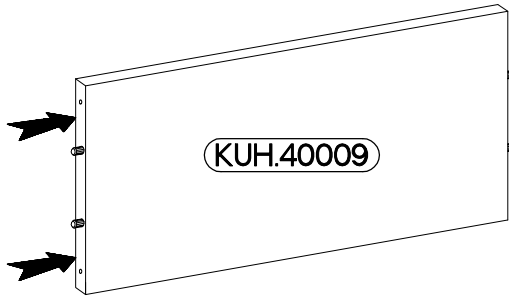
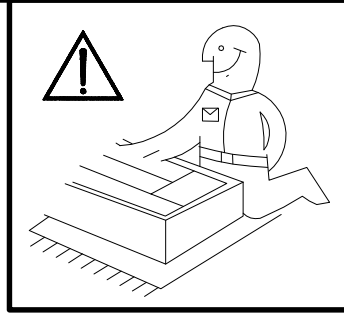

2

6,4 x 50mm		
		
B	O	E1
4	1	4

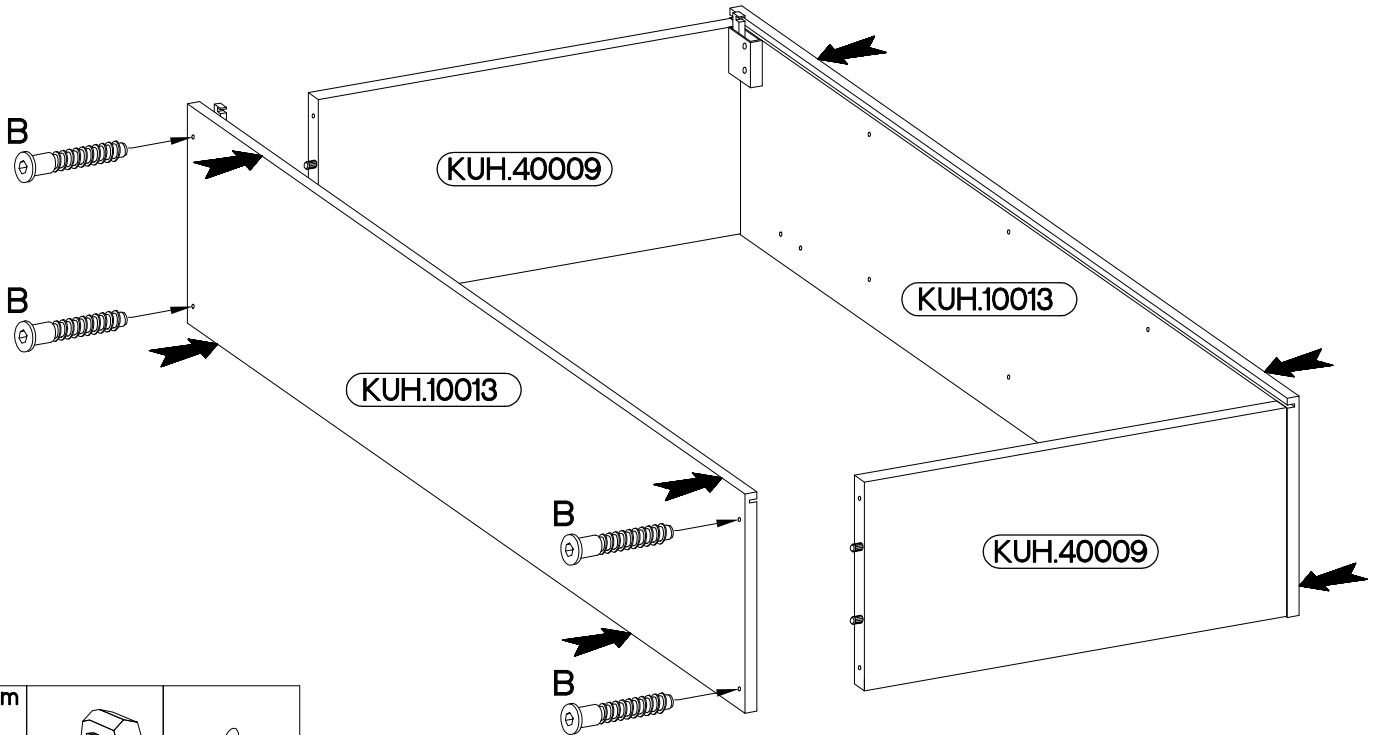

3

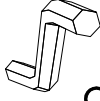

6,4 x 50mm		
		
B	O	E1
4	1	4

4

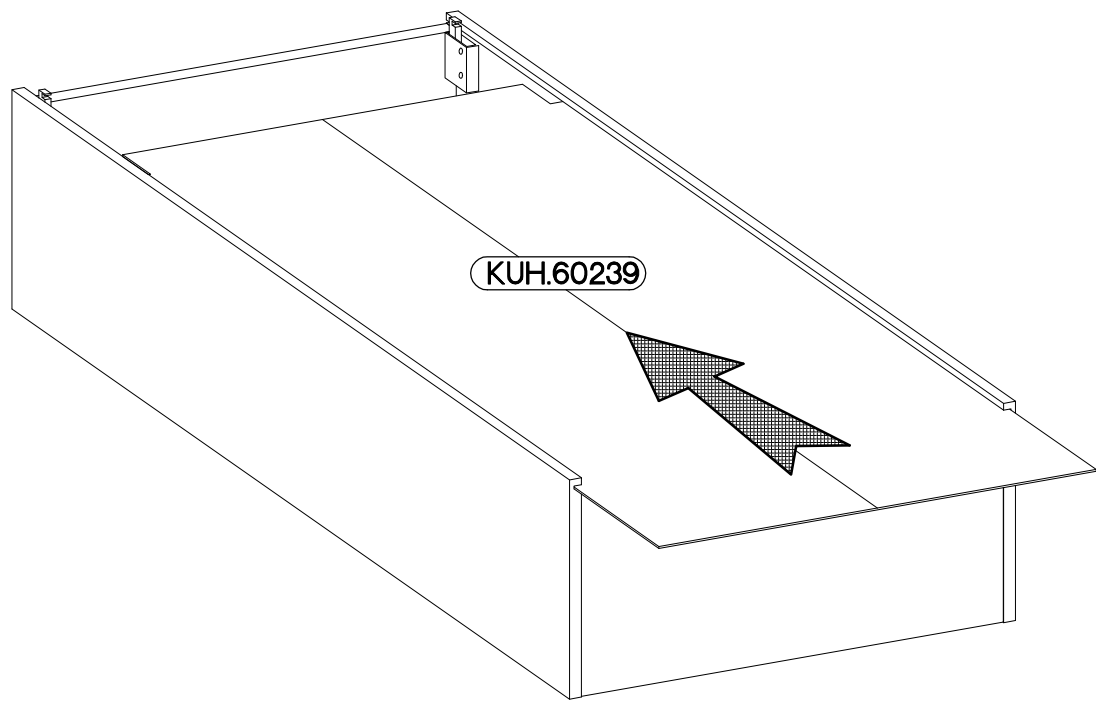
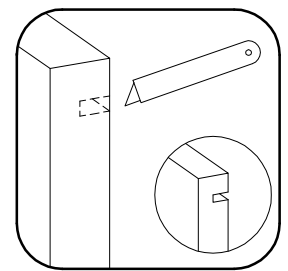
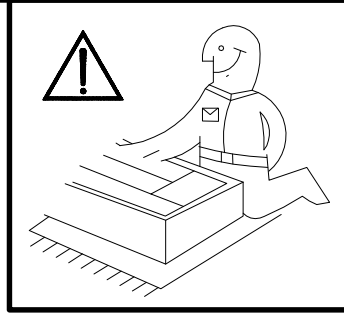

5

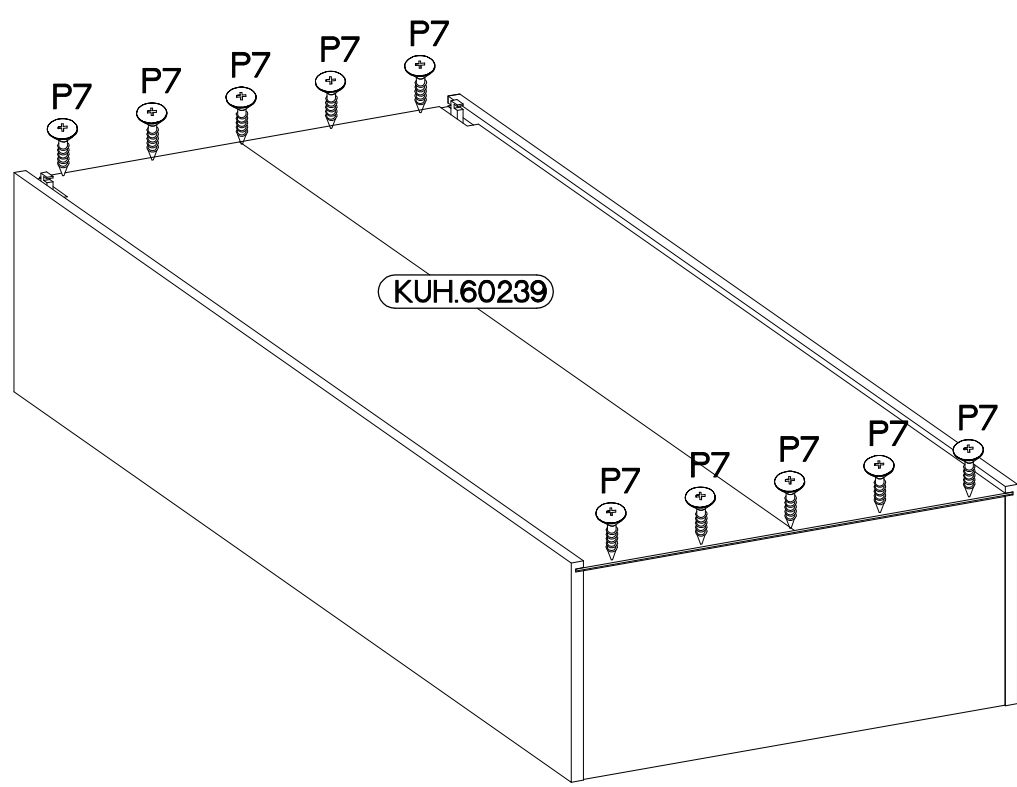
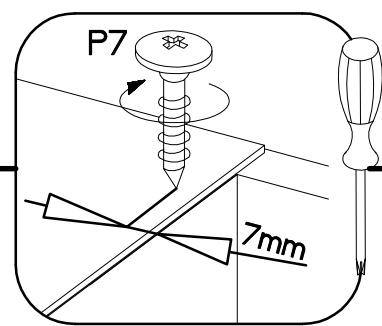
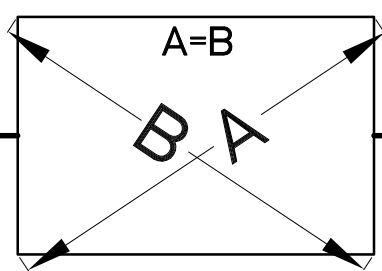
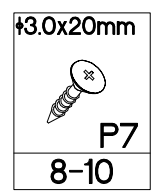

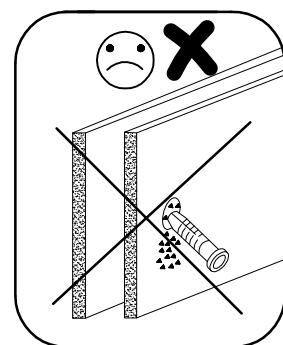
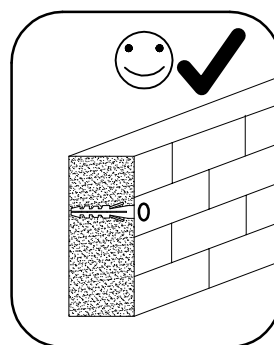
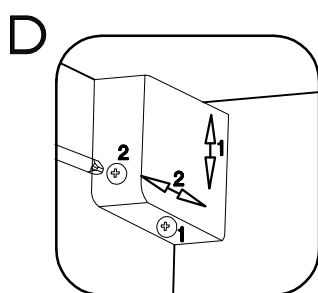
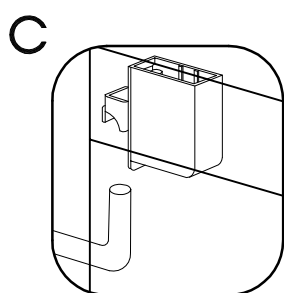
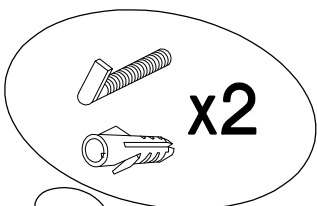
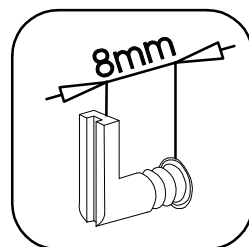
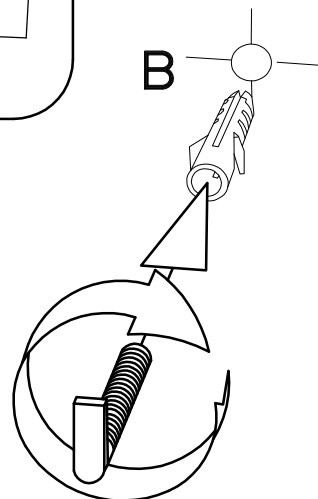
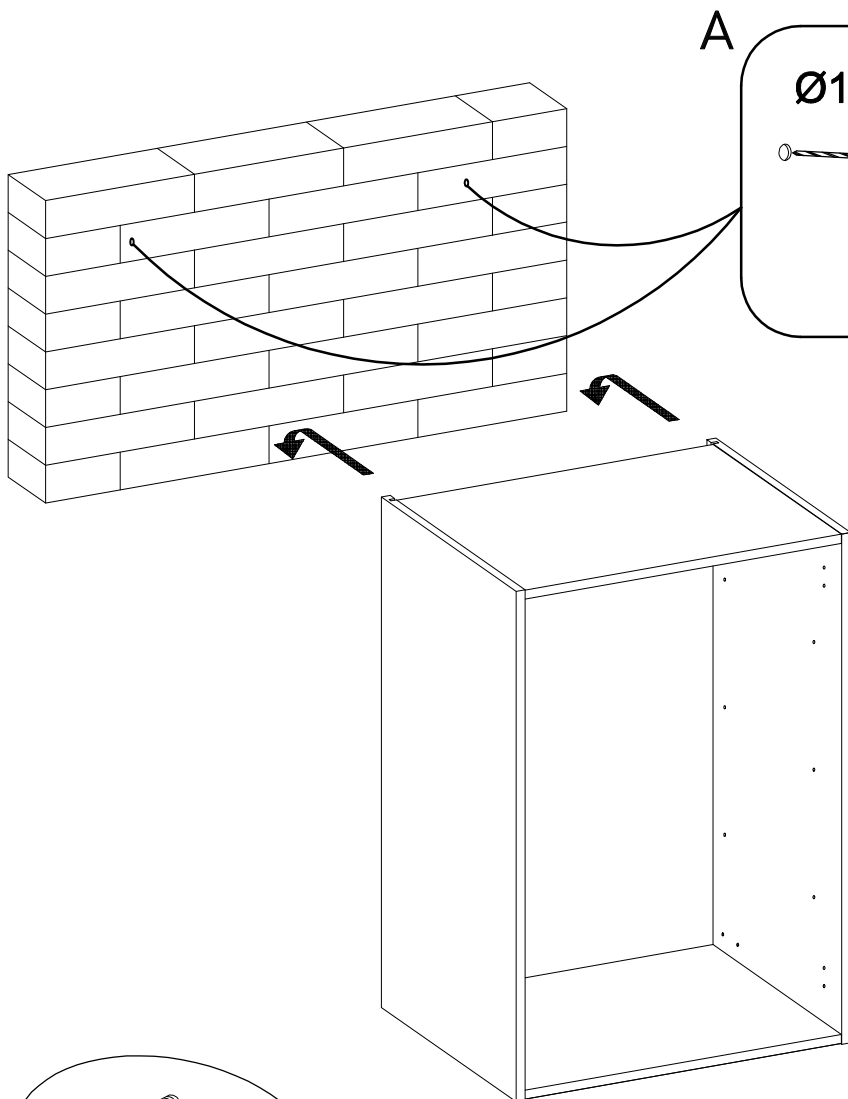
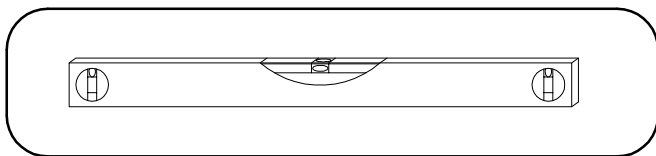

7

±5/19mm
J
12

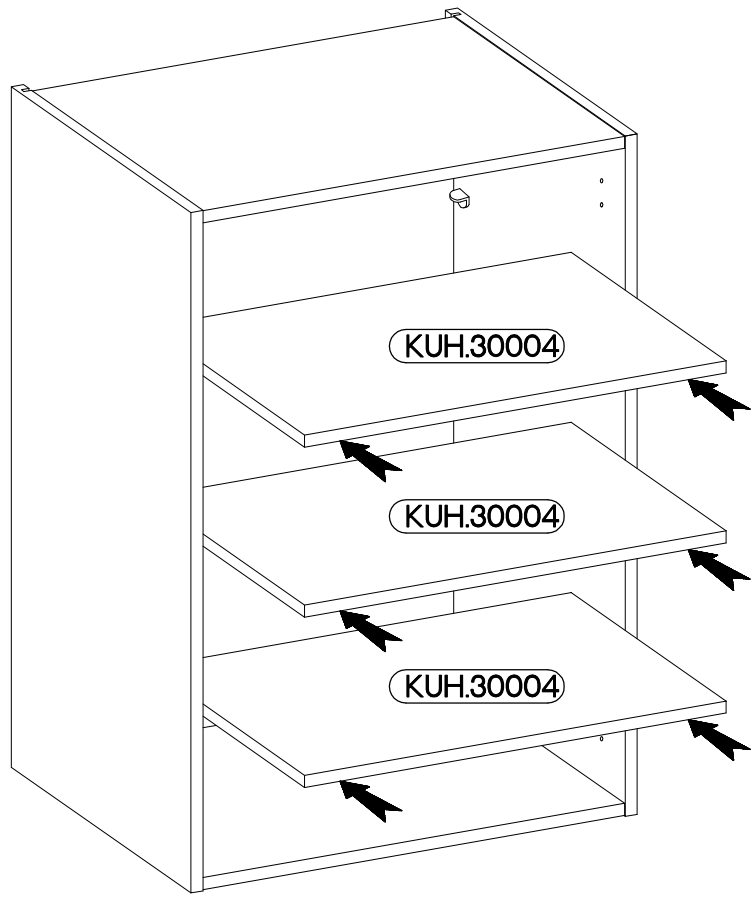
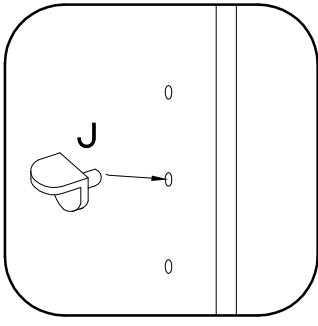

8

FRONT

