

Ø10mm
40 G-72 1F

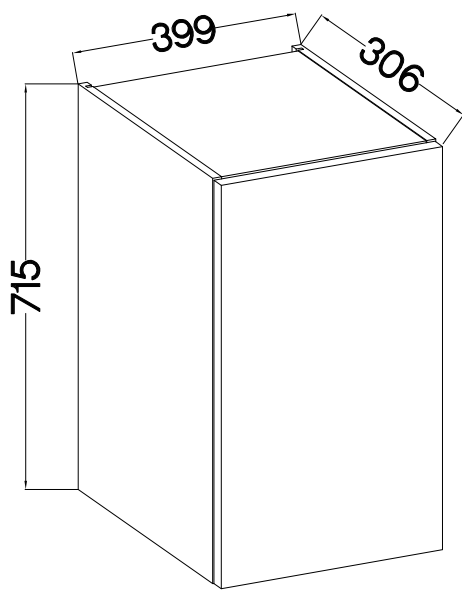

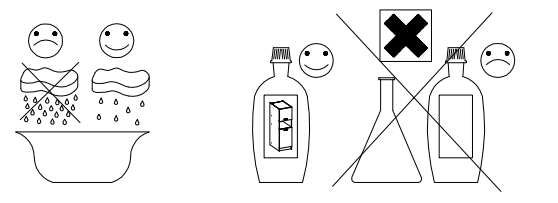

max. 5kg
KUH.30008
KUH.40019

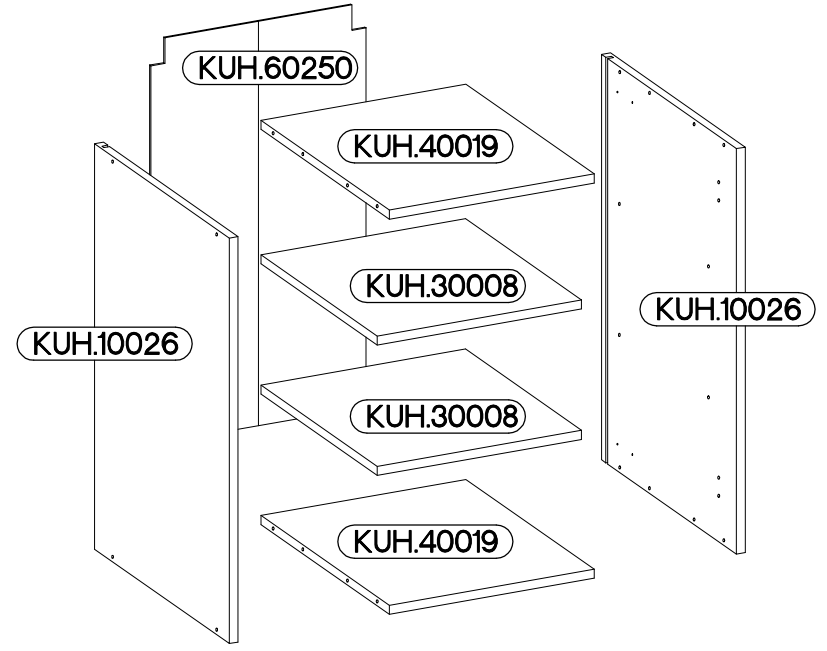
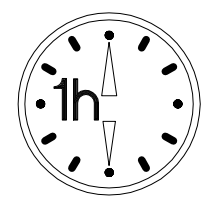

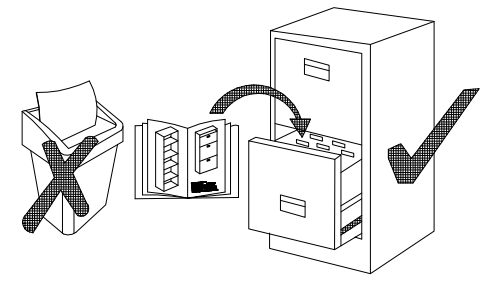
 8x30mm A 8	 6,4 x 50mm B 8	 E1 8	 HG 2	 3.5x13mm P5 4	 3.0x20mm P7 8-10	 4.0x30mm P8 4
 J 8	 K 2	 O 1				



ISM-KUH-01134

 A 8	 P8 4	 K 2
--	---	--

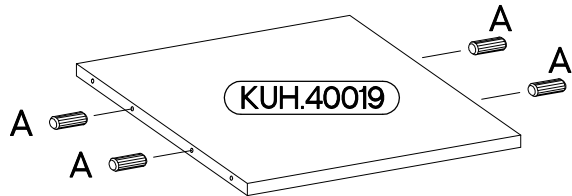
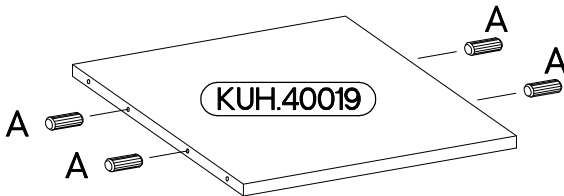
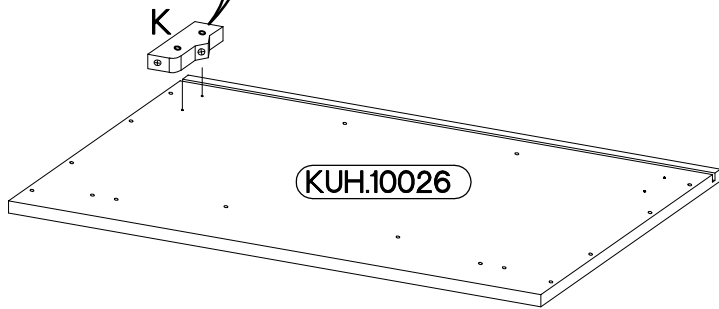
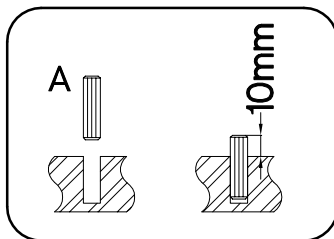
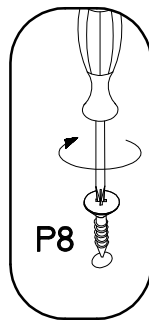
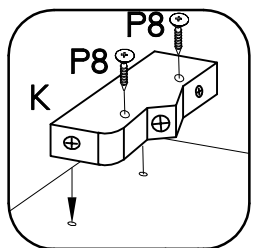
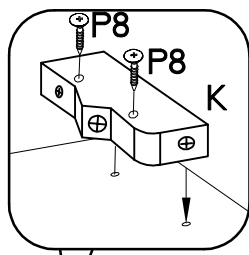
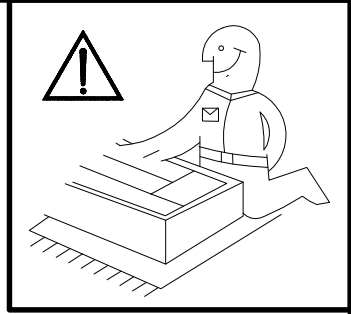

2

6,4 x 50mm

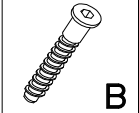

B

4

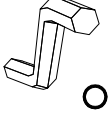

O

1



E1

4

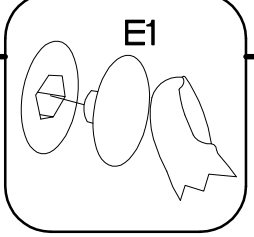
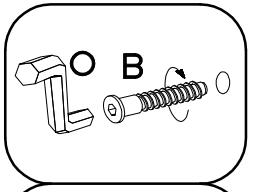
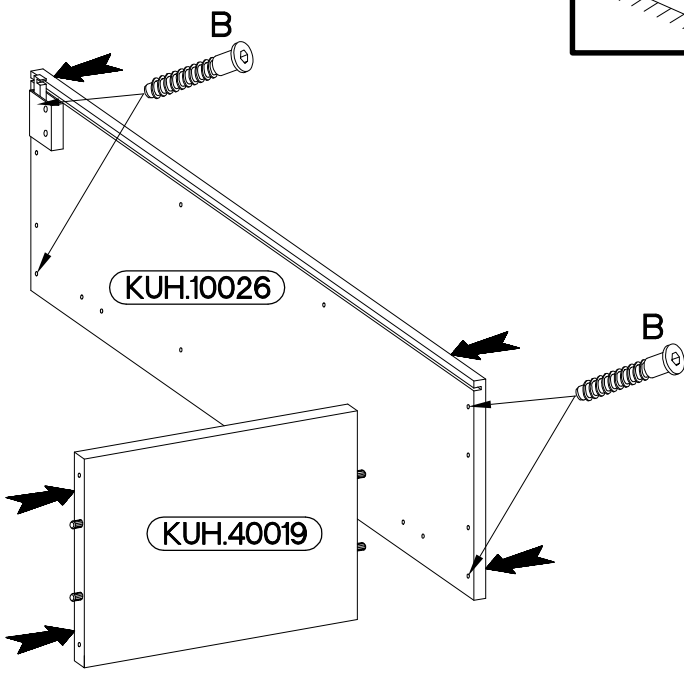
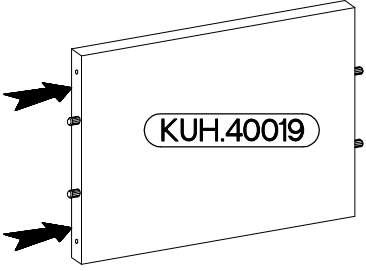
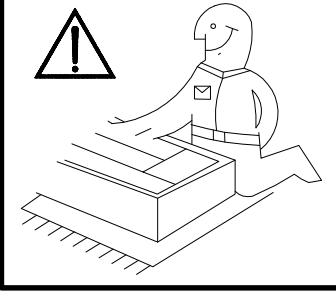

3

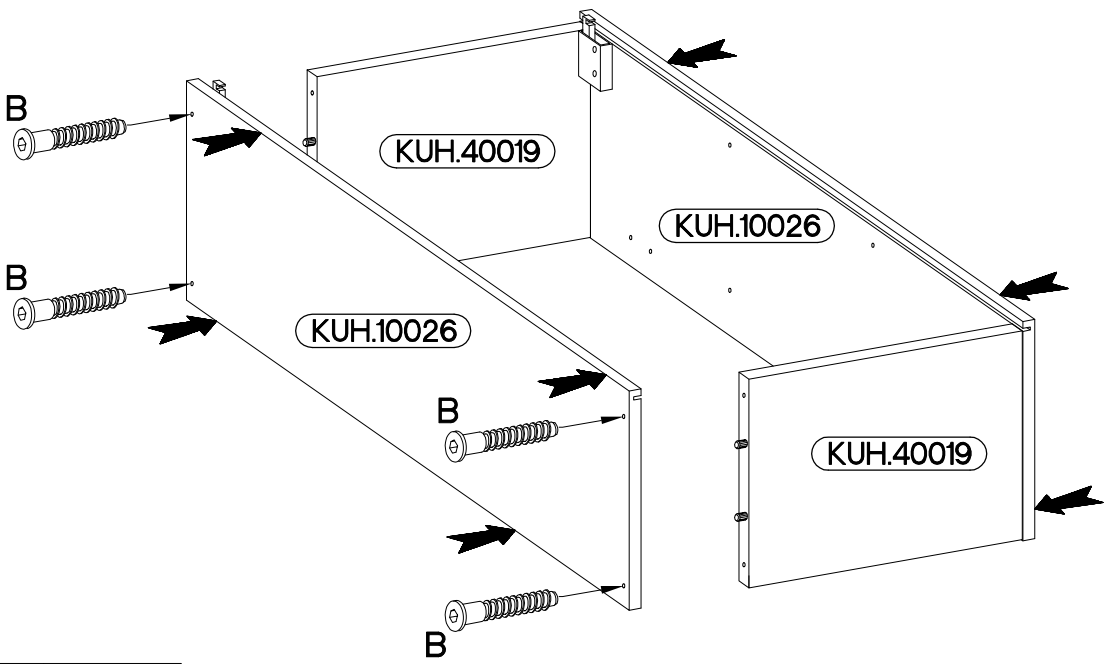

6,4 x 50mm

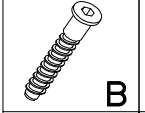

B

4

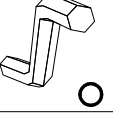

O

1



E1

4

4

4

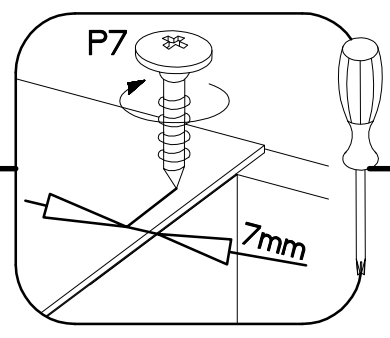
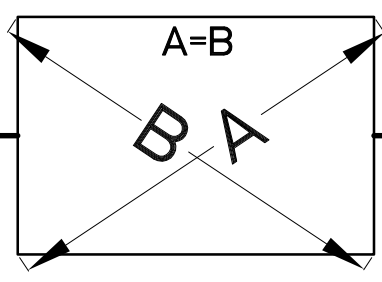
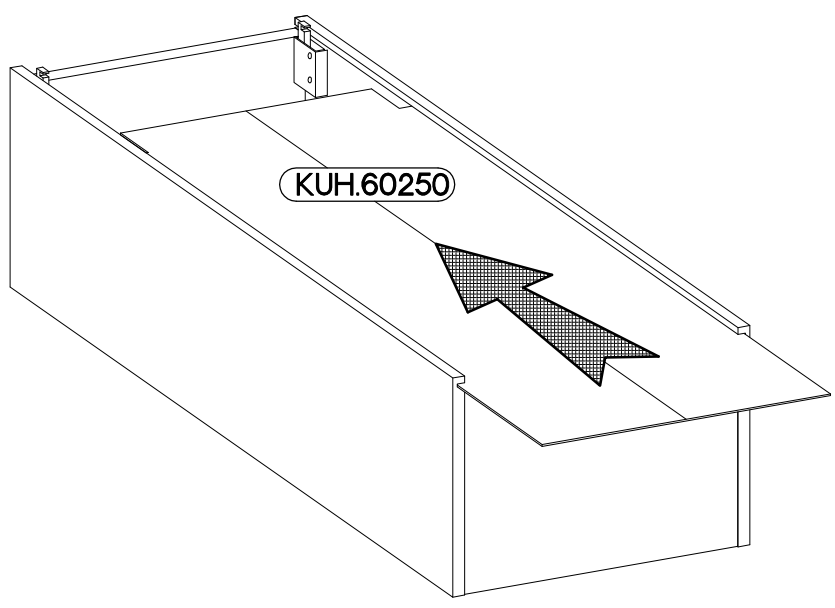
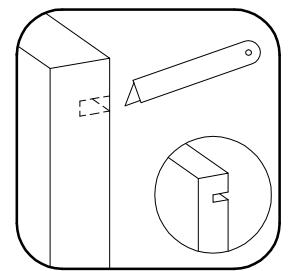
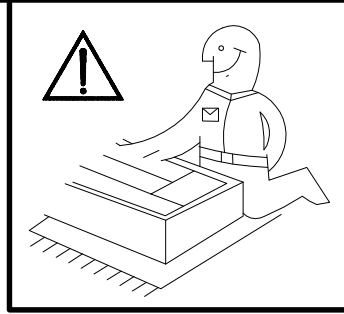

5

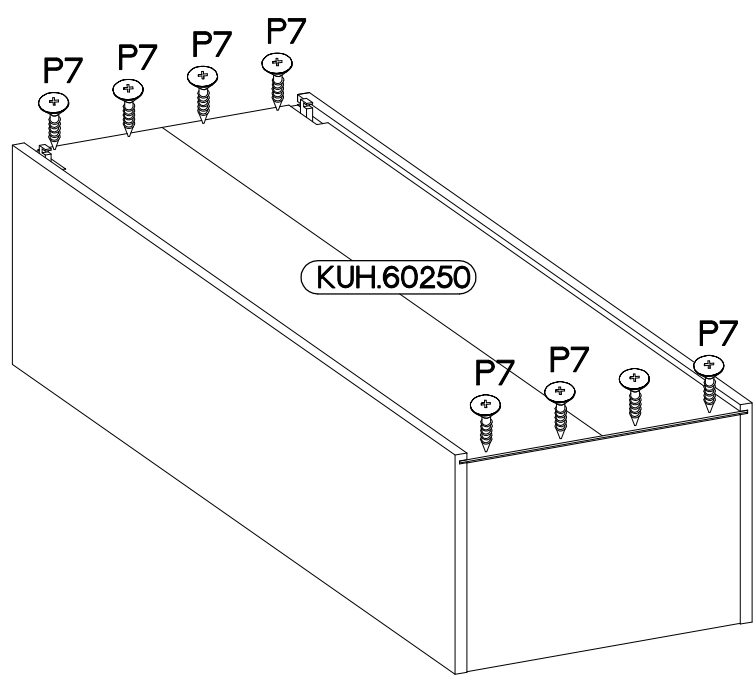
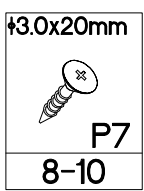

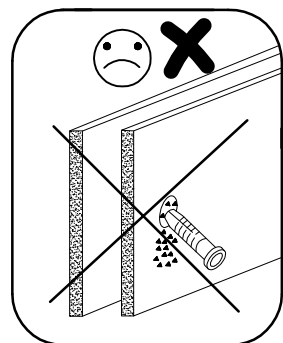
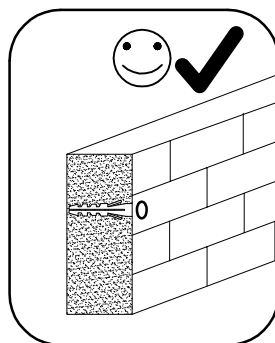
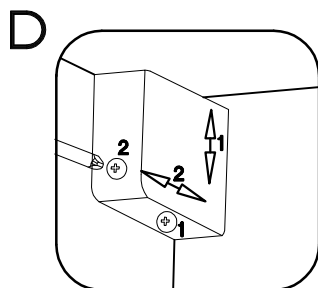
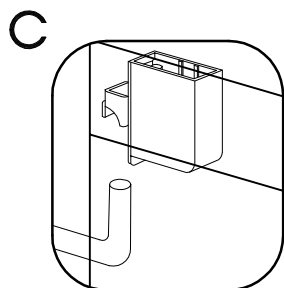
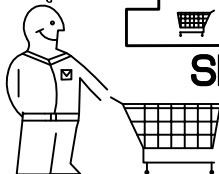
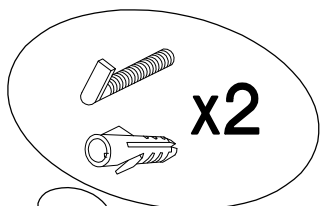
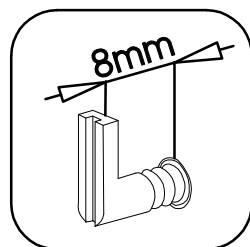
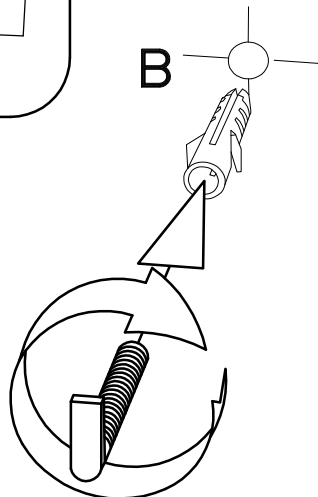
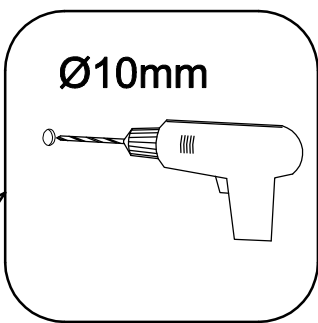
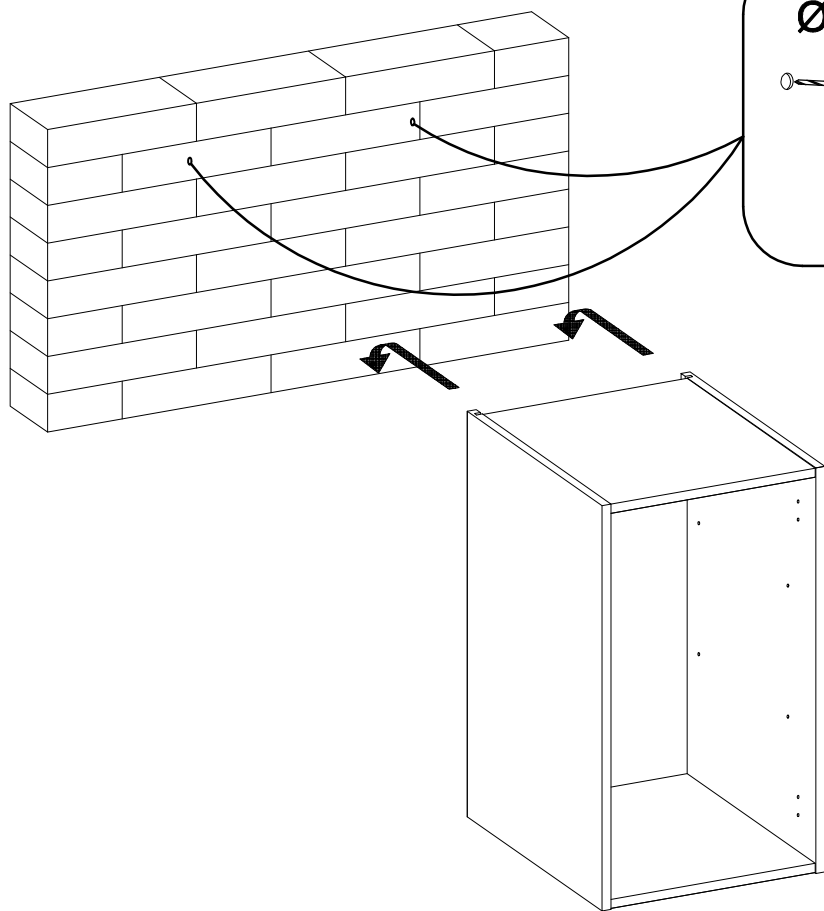
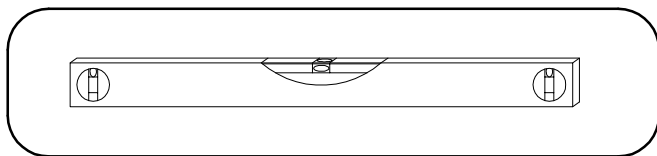

7

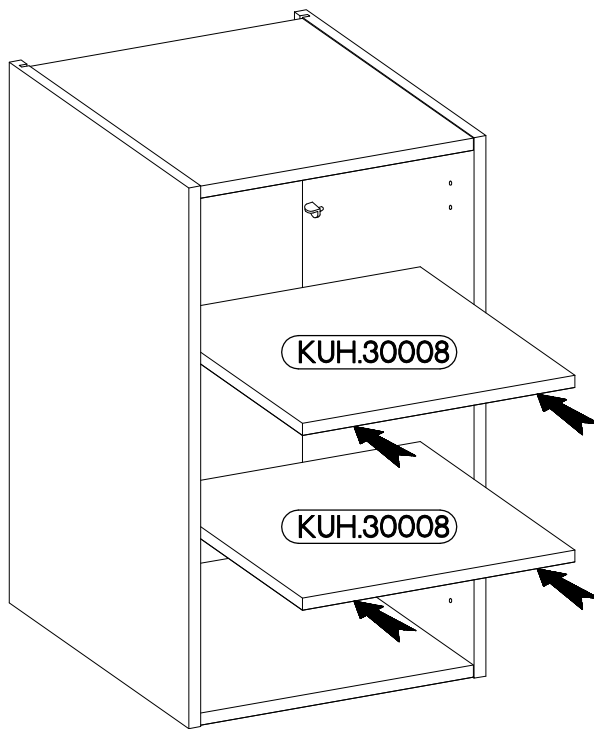
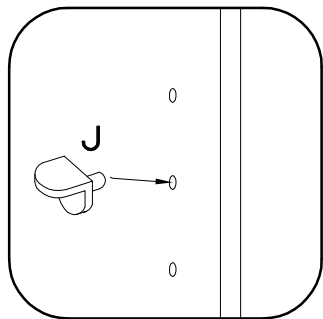
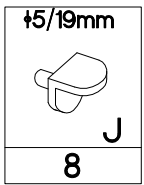

8

FRONT

