

60 LO-2100

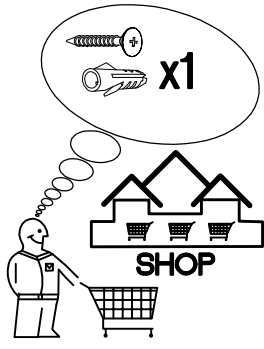

$\pm 8 \times 30 \text{mm}$	$6,4 \times 50 \text{mm}$	$\pm 15/12 \text{mm}$
A	B	C
8	8	12

L=20mm				6.5x48x16	$\pm 35/0 \text{mm}$	$\pm 5/19 \text{mm}$
D2	E	E1	E9	F2	HG	J
12	12	8	2	4	5	4
		$\pm 4.0 \times 16 \text{mm}$	$\pm 4.0 \times 45 \text{mm}$	$\pm 3.5 \times 13 \text{mm}$	$\pm 3.0 \times 20 \text{mm}$	
L25	O	P1	P4	P5	P7	T4
1	1	16	2	12	15-20	4

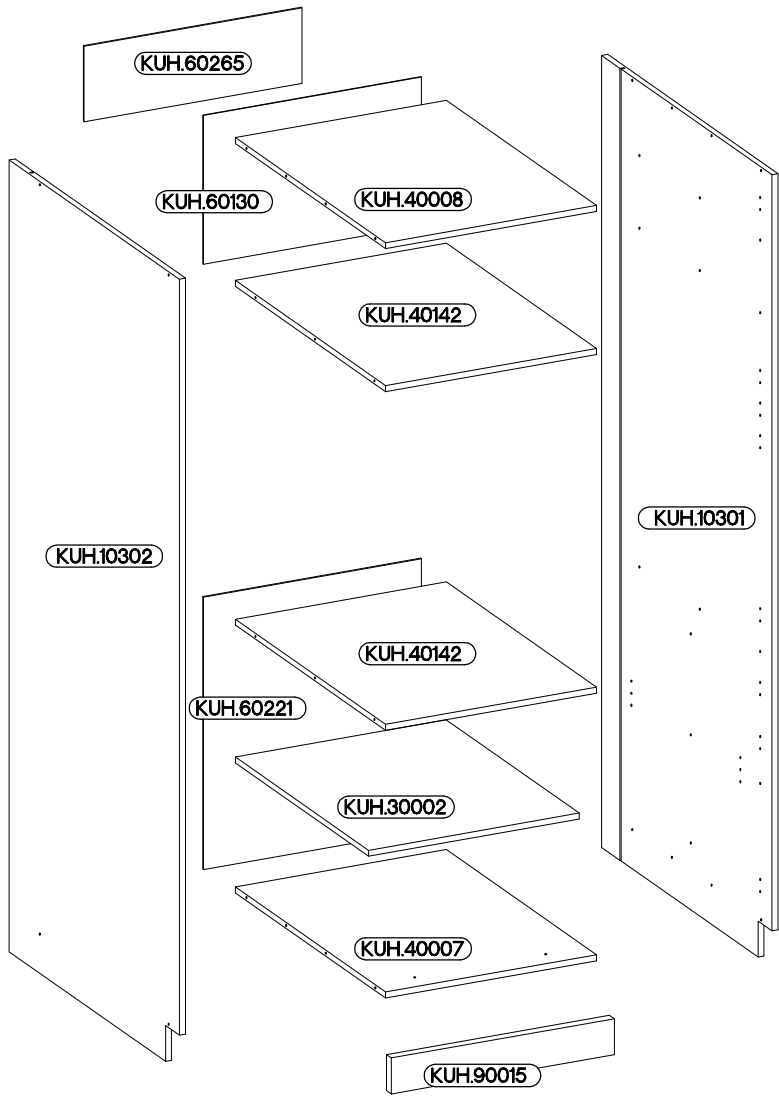
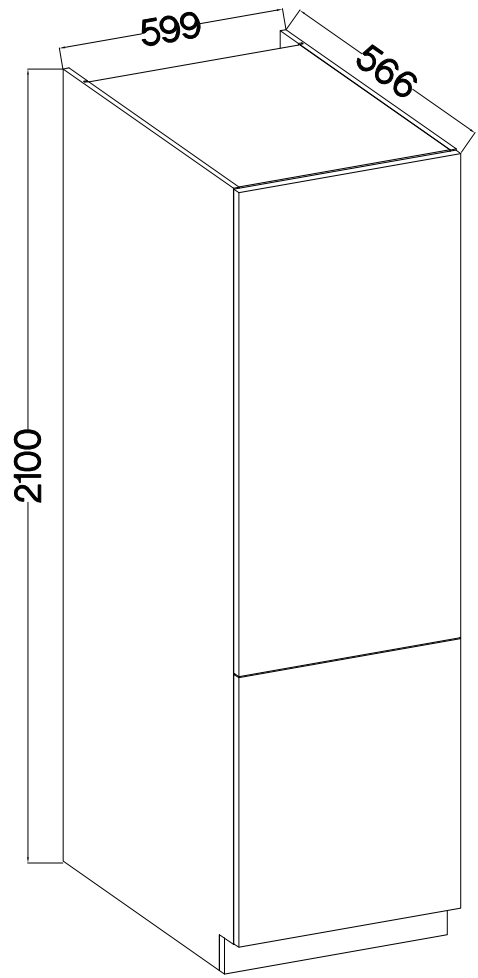
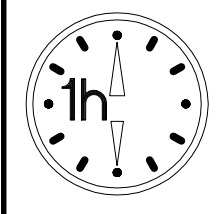
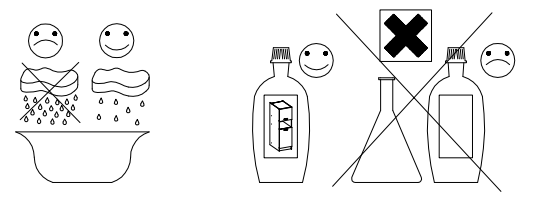
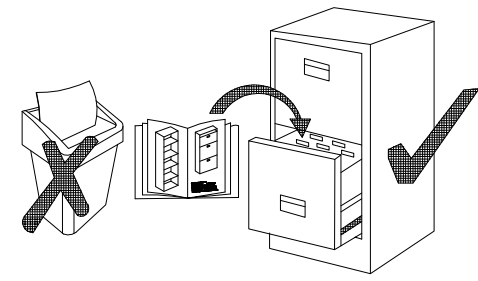

ISM-KUH-01148

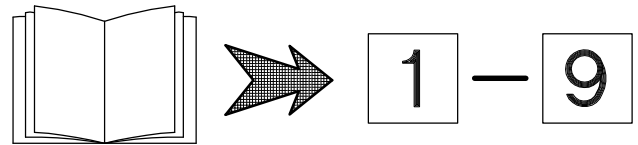
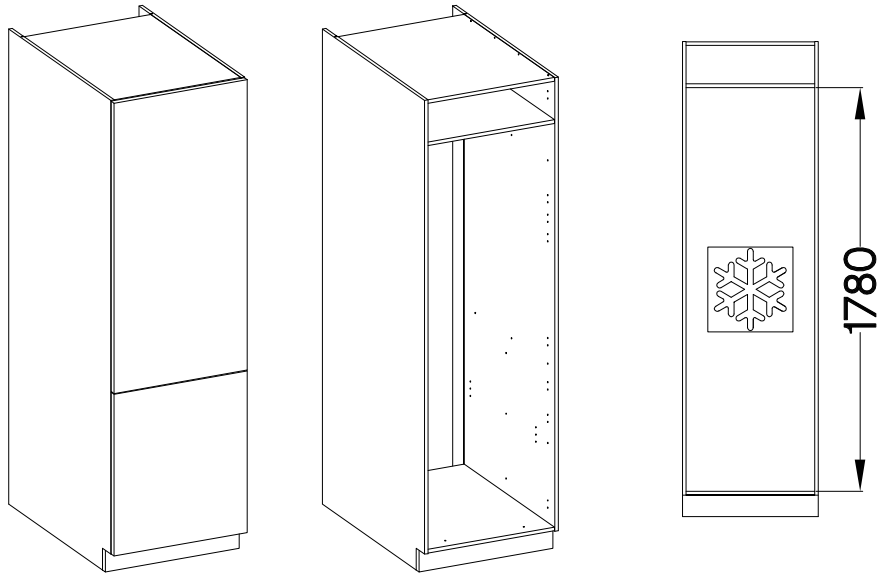



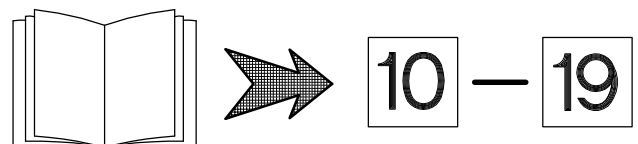
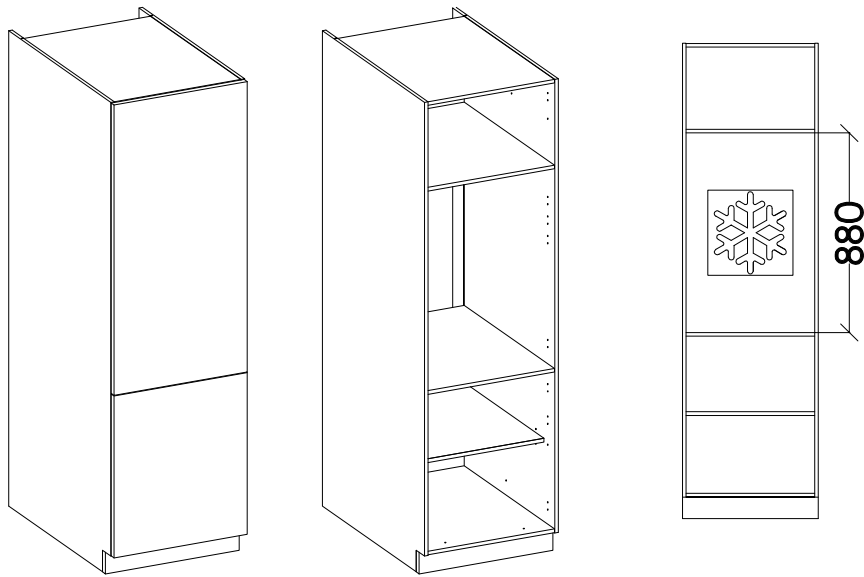

## WARIANT B

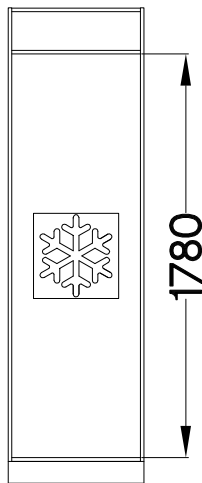
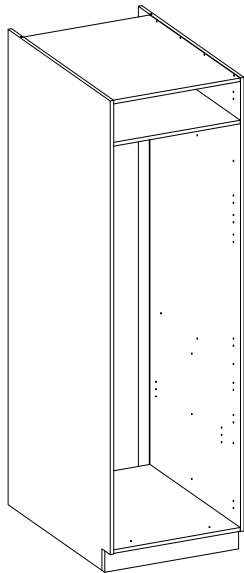

1

# WARIANT A



$\varnothing 8 \times 30 \text{mm}$  A	$6.5 \times 48 \times 16$  F2
8 L=20mm	4 $\varnothing 15 / 12 \text{mm}$
 D2	 C
6	6

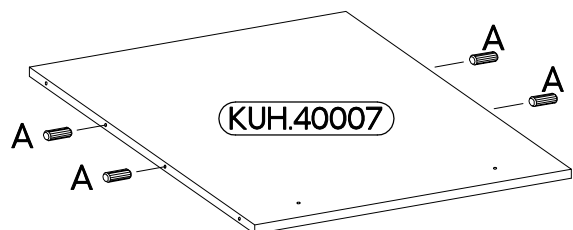
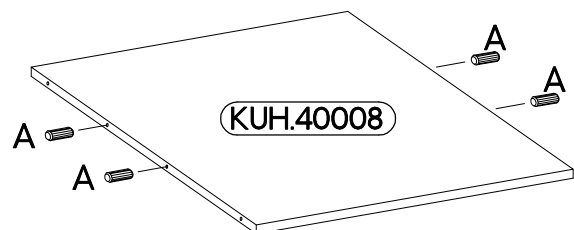
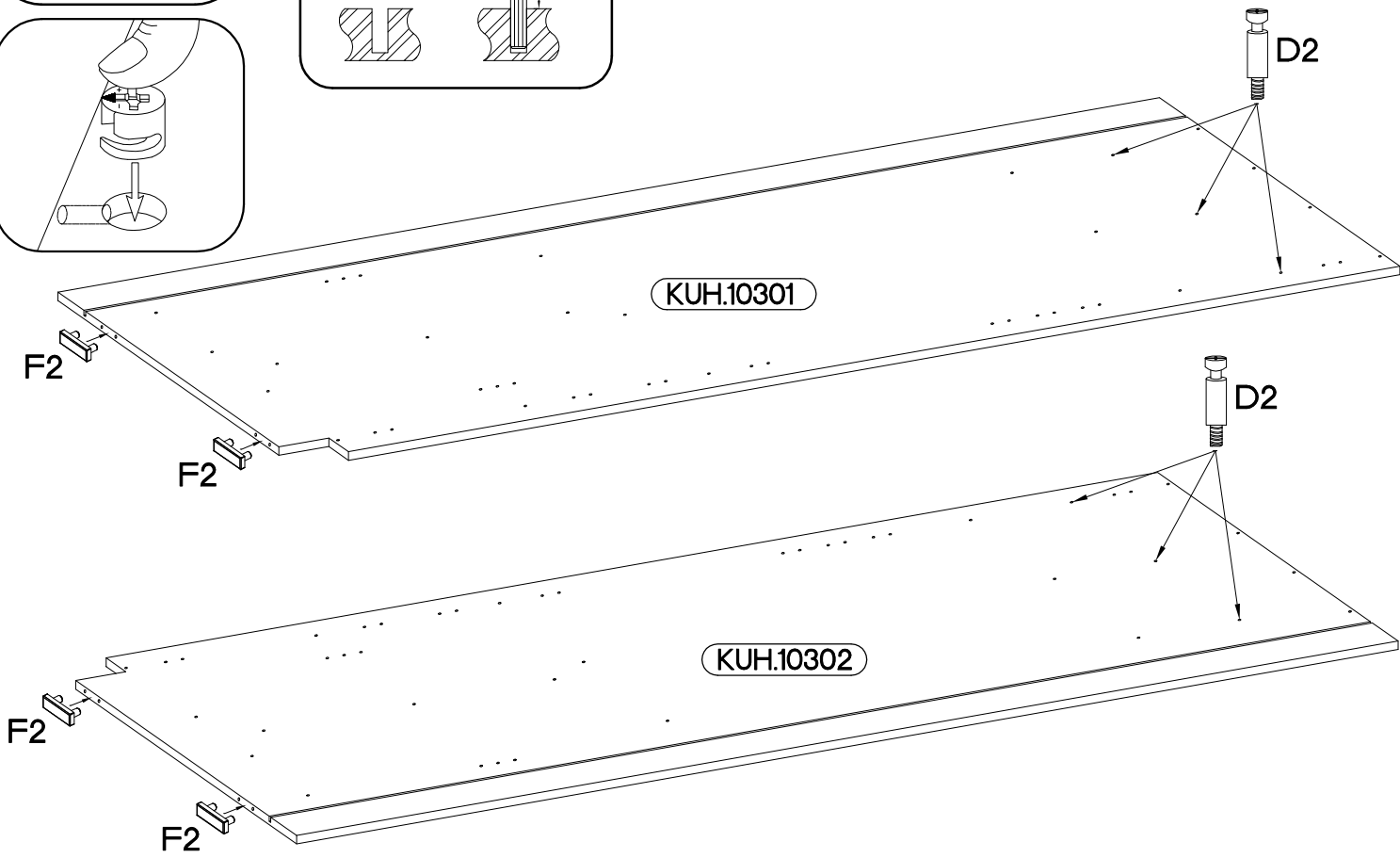
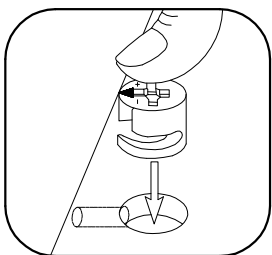
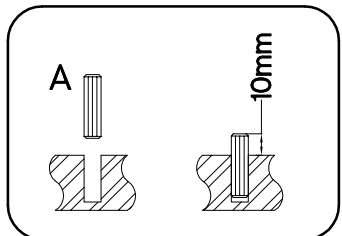
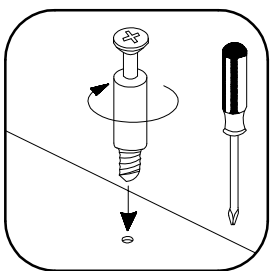
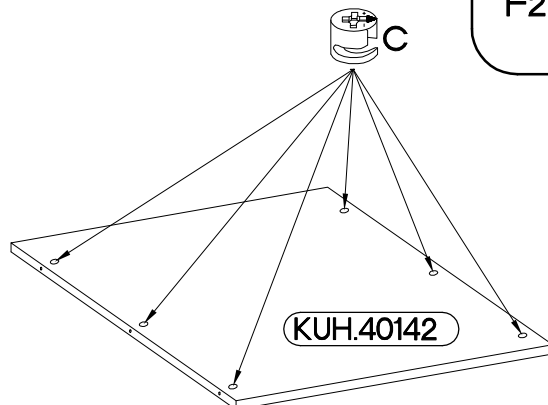
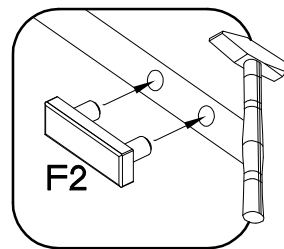
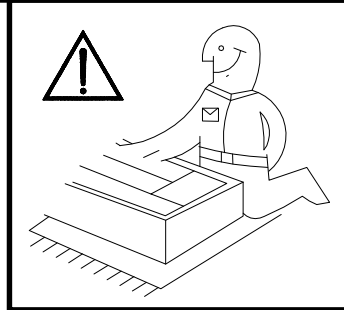

# 2

6,4 x 50mm

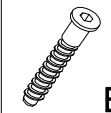

B

4

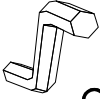

O

1



E1

4

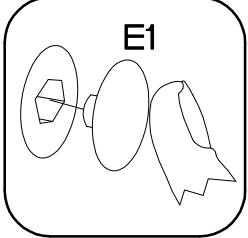
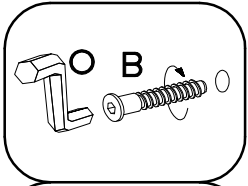
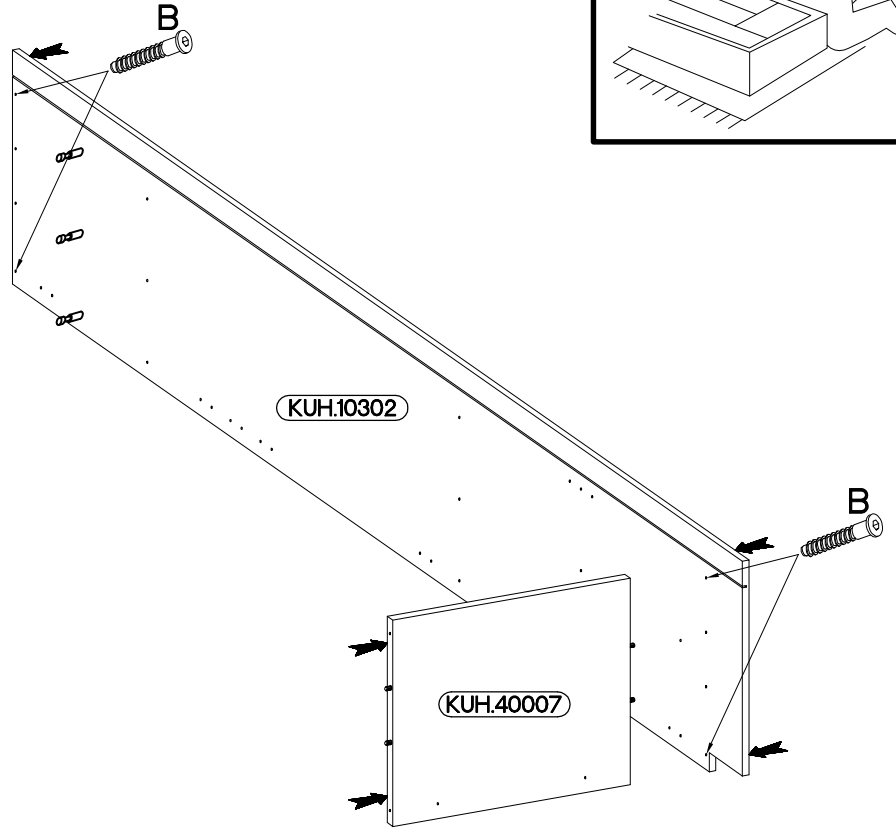
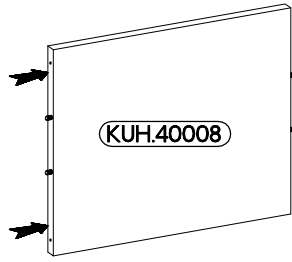
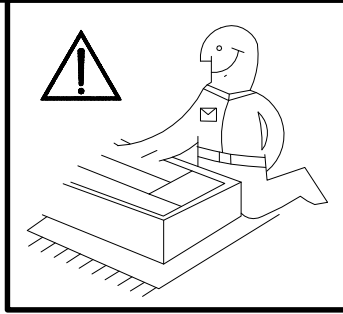



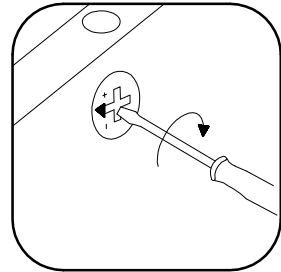
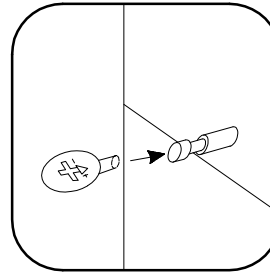
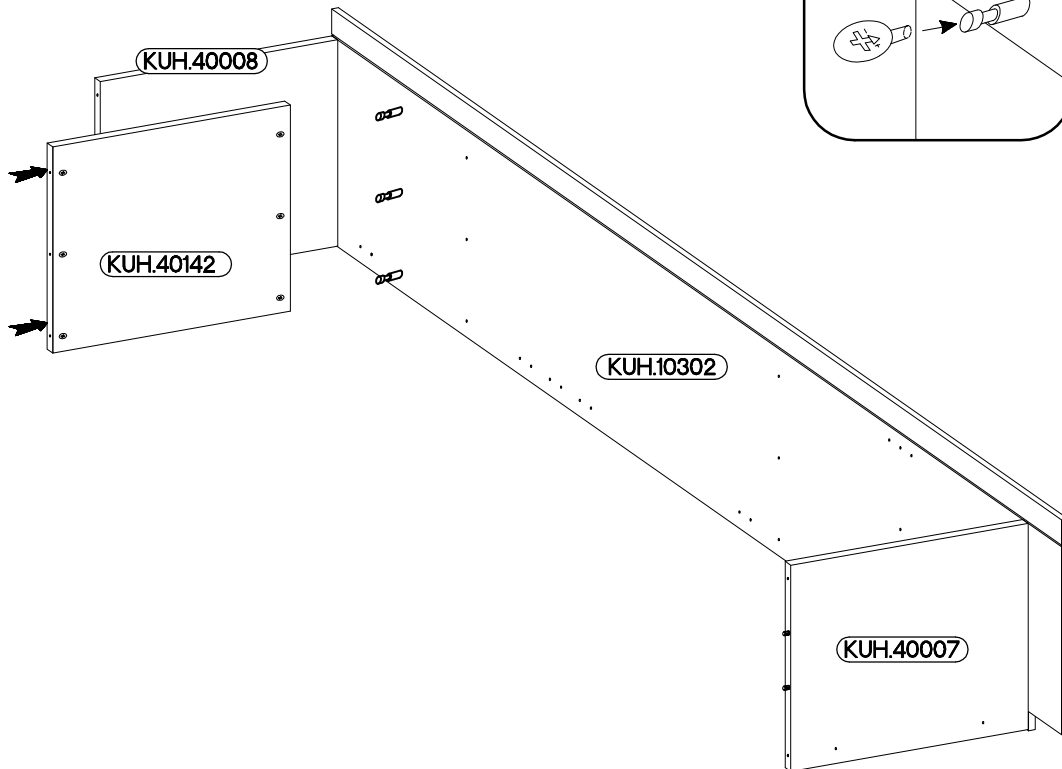

# 3





# 4

6,4 x 50mm

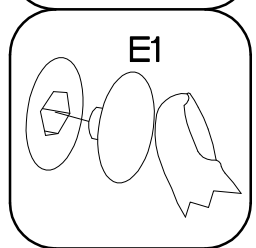
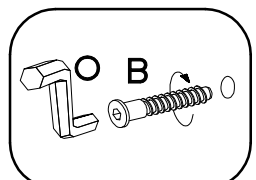
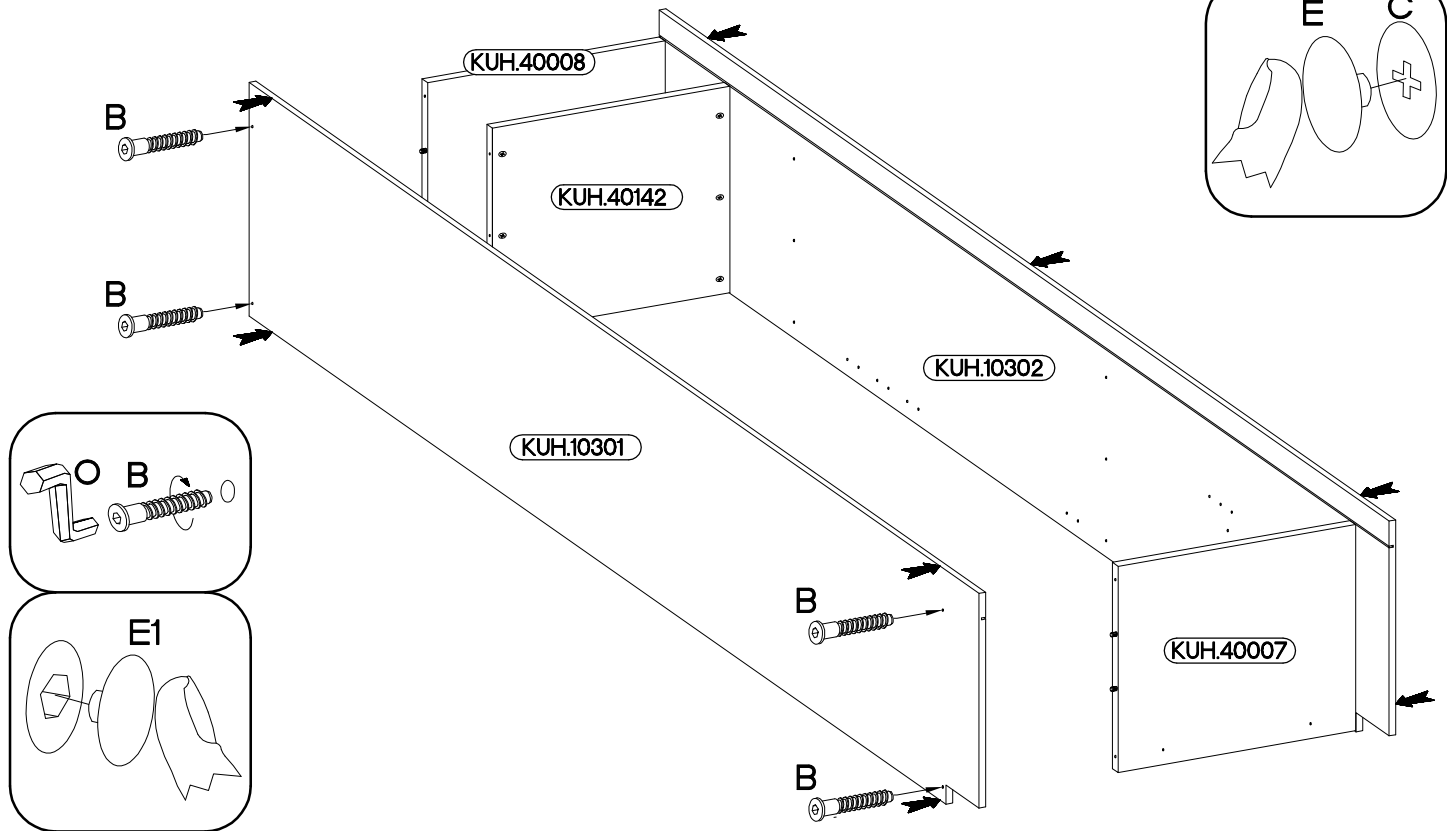
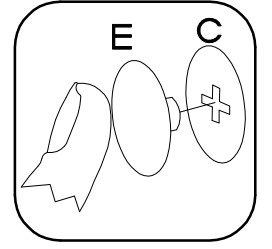
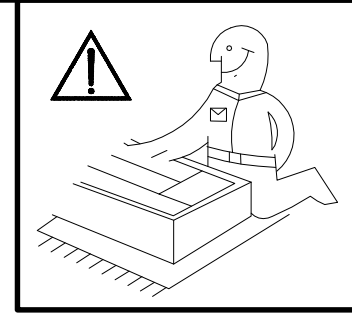
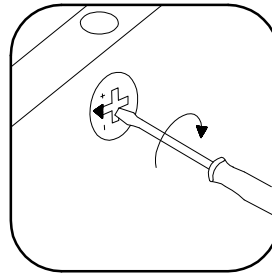
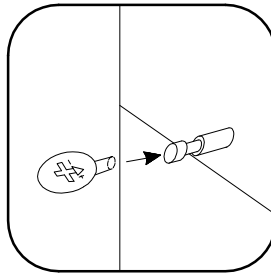
			
<b>B</b>	<b>O</b>	<b>E1</b>	<b>E</b>
4	1	4	6



# 5

	
<b>T4</b>	<b>P1</b>
4	16

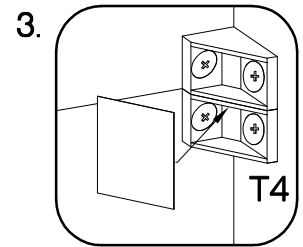
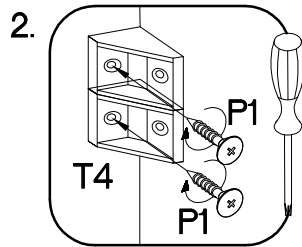
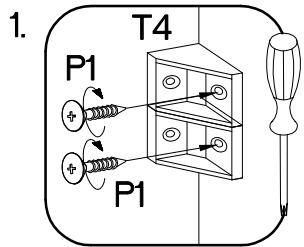
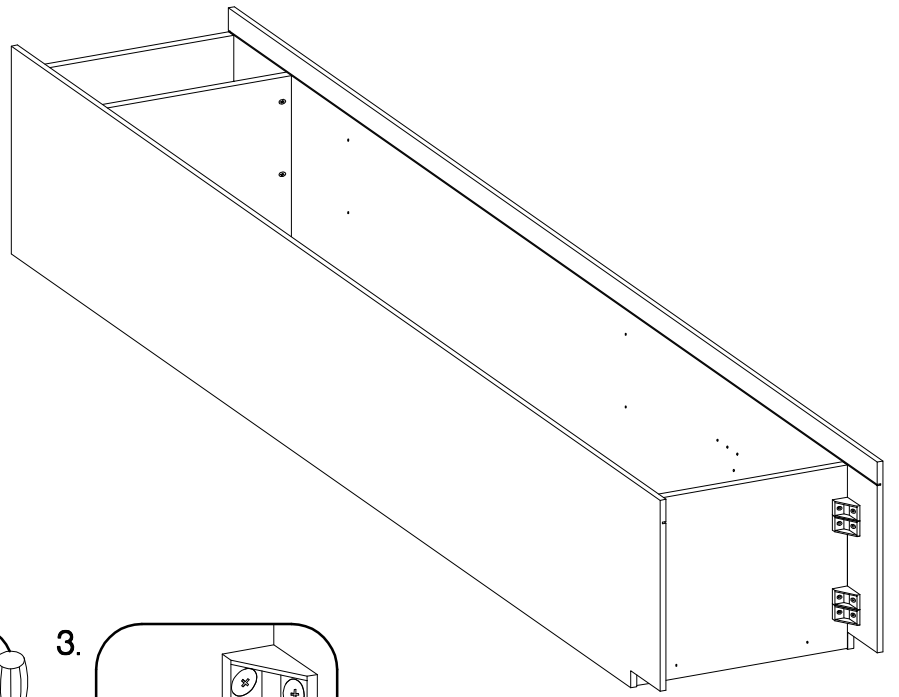
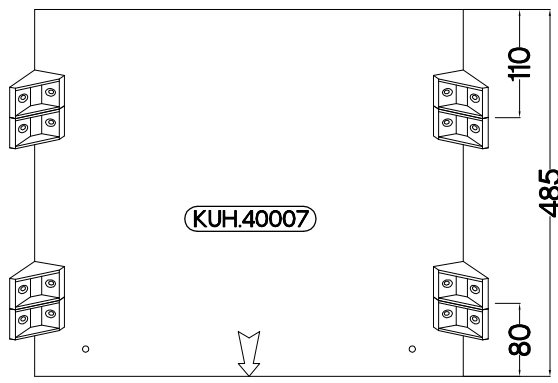

+4.0x16mm

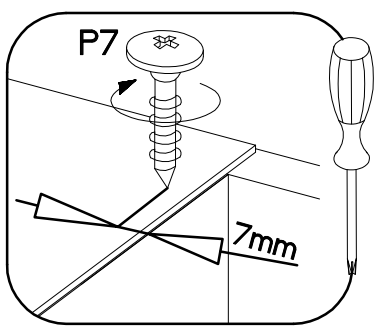
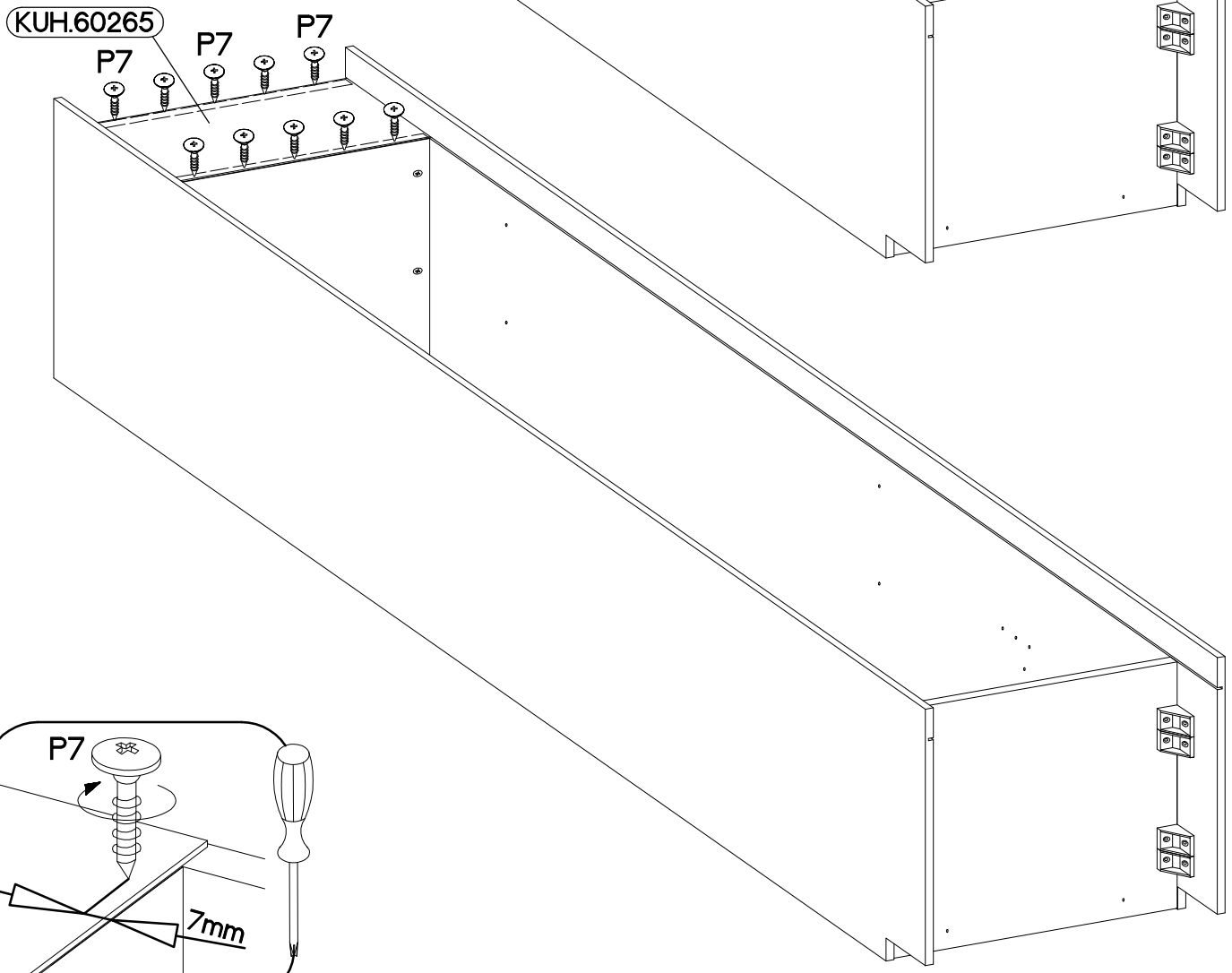
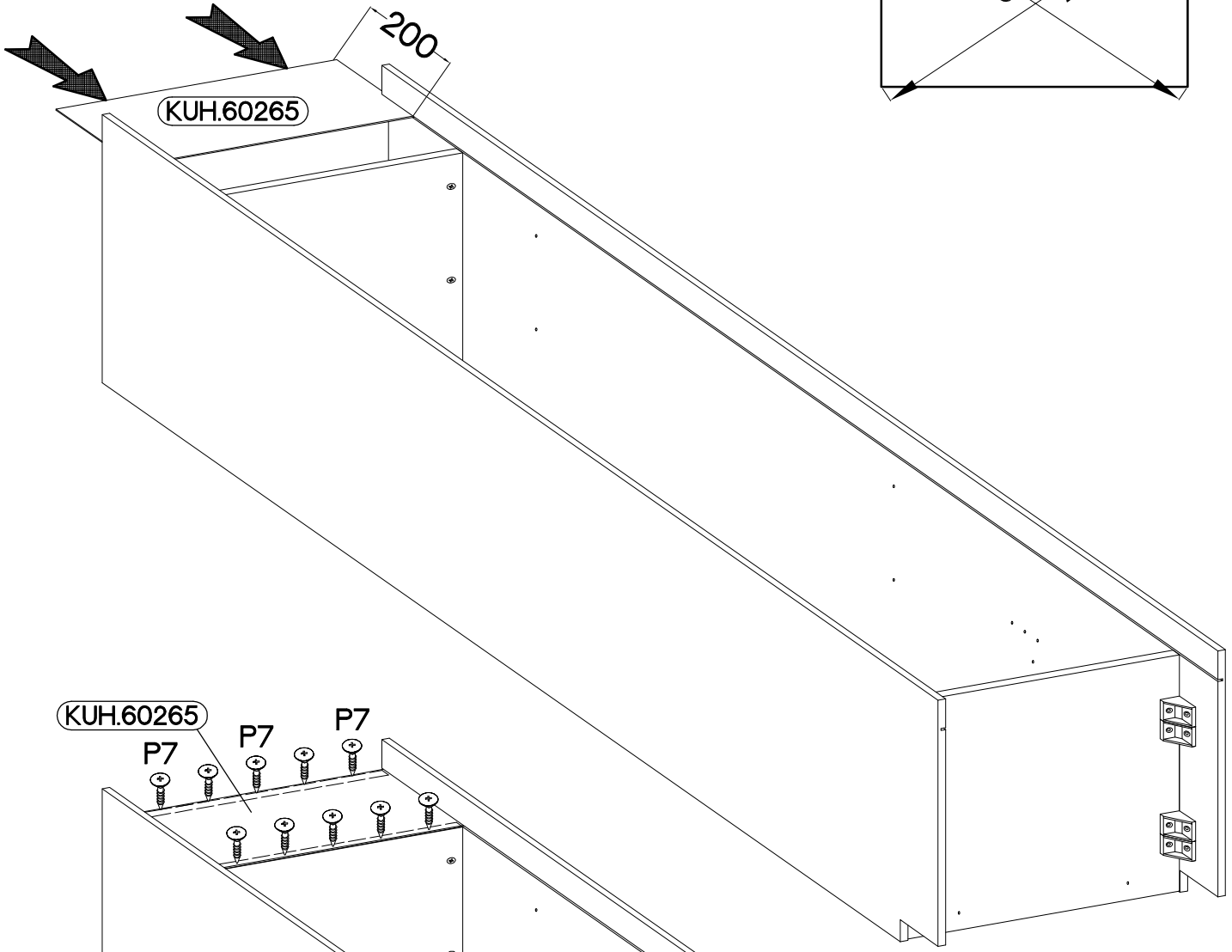
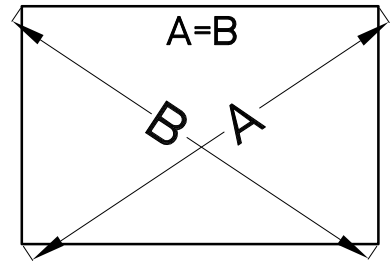

6

±3.0x20mm  
P7  
8-10

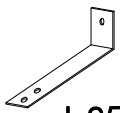

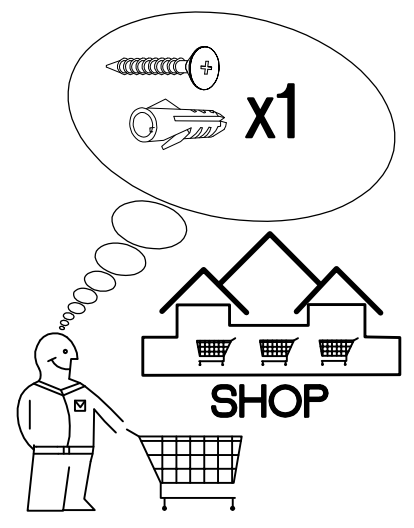
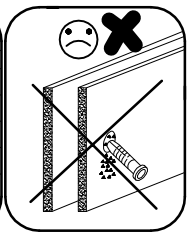
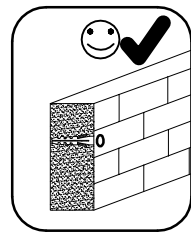
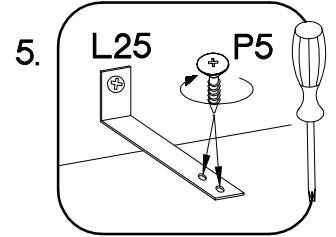
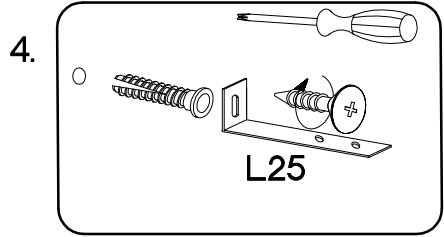
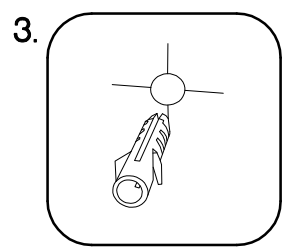
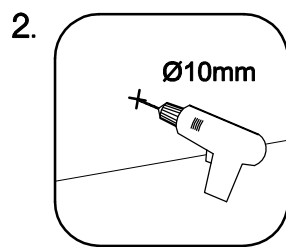
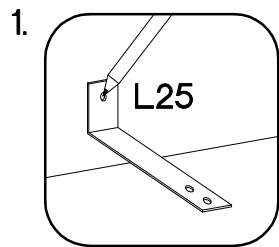

 L25 1	 P5 2
--	---

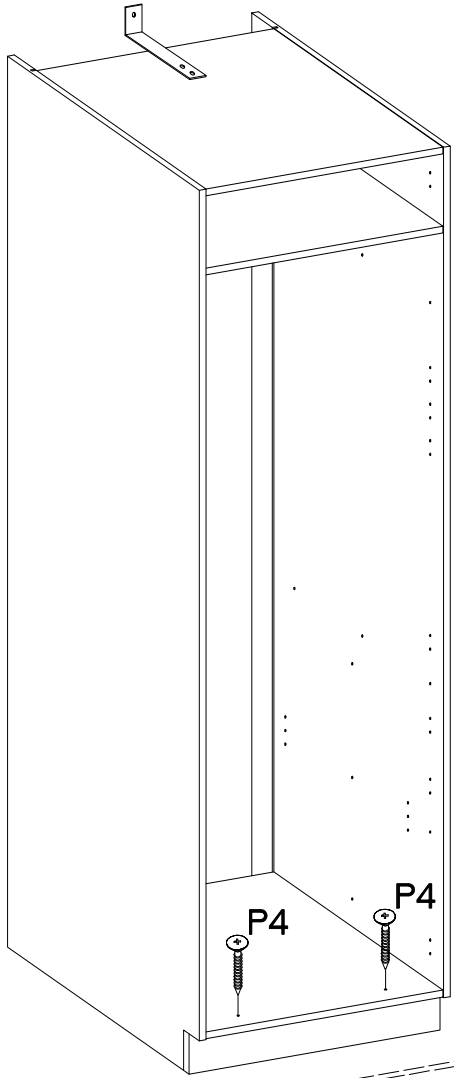

8



+4.0x45mm  P4	 E9
2	2

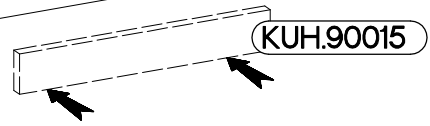
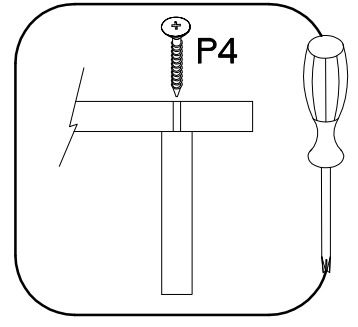

9

