

Ø10mm

40 G-90 1F WS

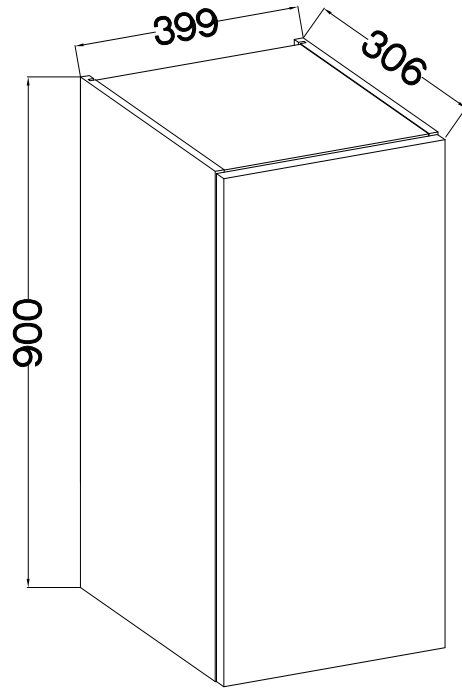

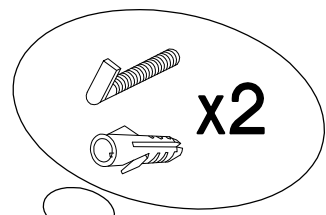
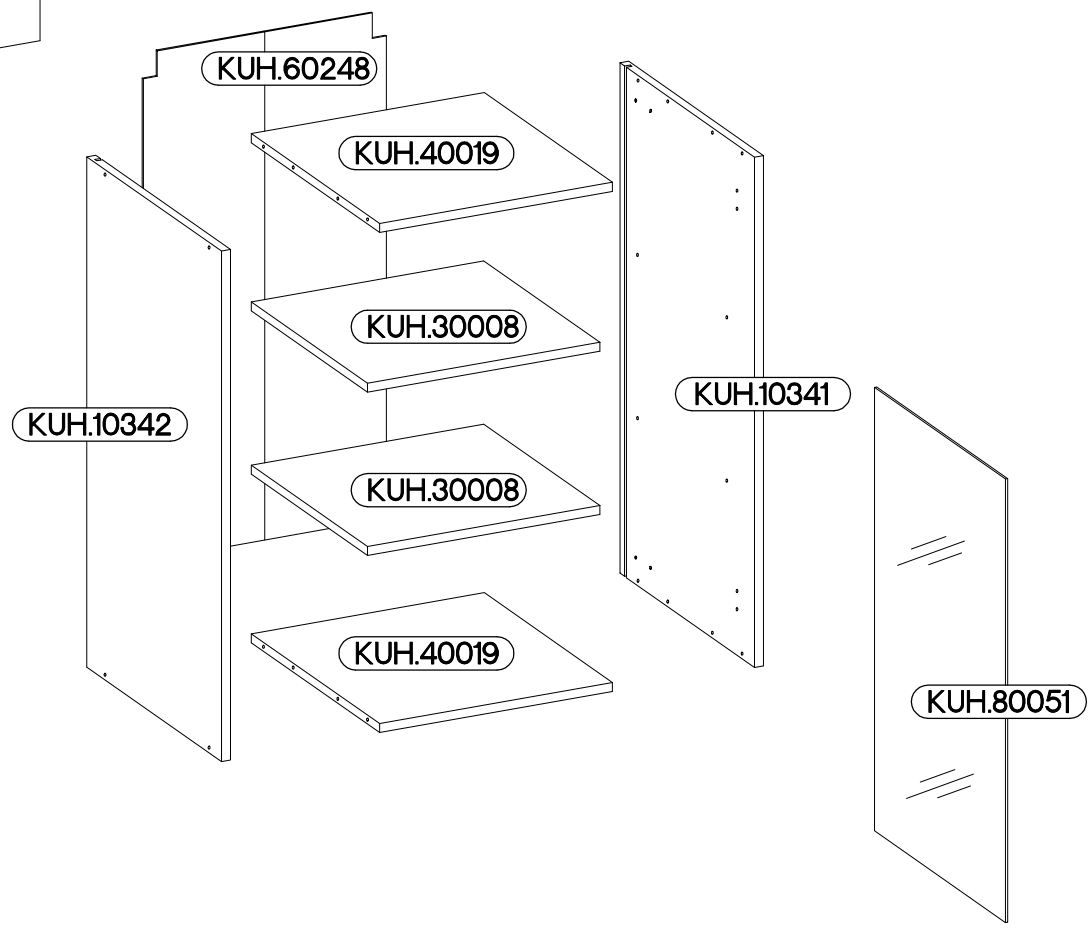
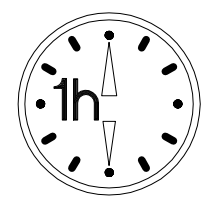

KUH.30068  
KUH.40019

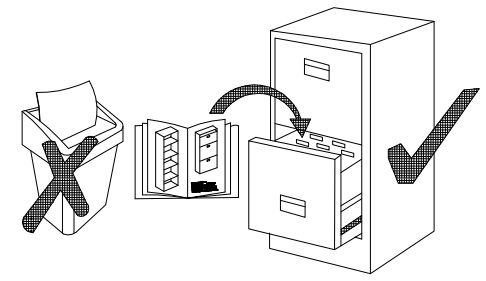

†8x30mm  A 8	6,4 x 50mm  B 8	 E1 8	†35/0mm  HG 2	†5/19mm  J 8		
 J8 10	 K 2	 O 1	†3.5x13mm  P5 4	†3.0x20mm  P7 8-10	†4.0x30mm  P8 4	†3.0x16mm  P11 10



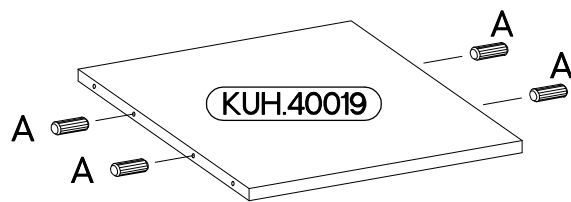
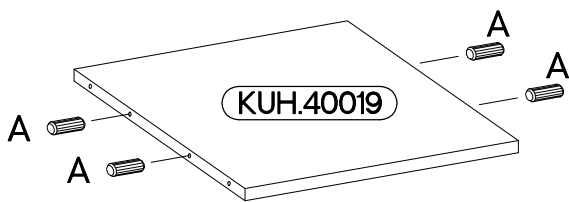
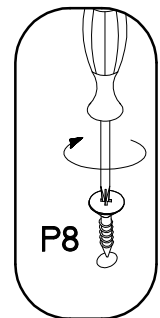
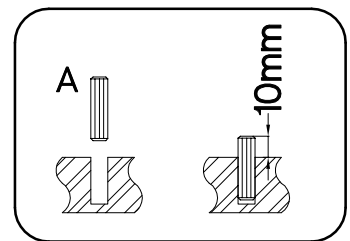
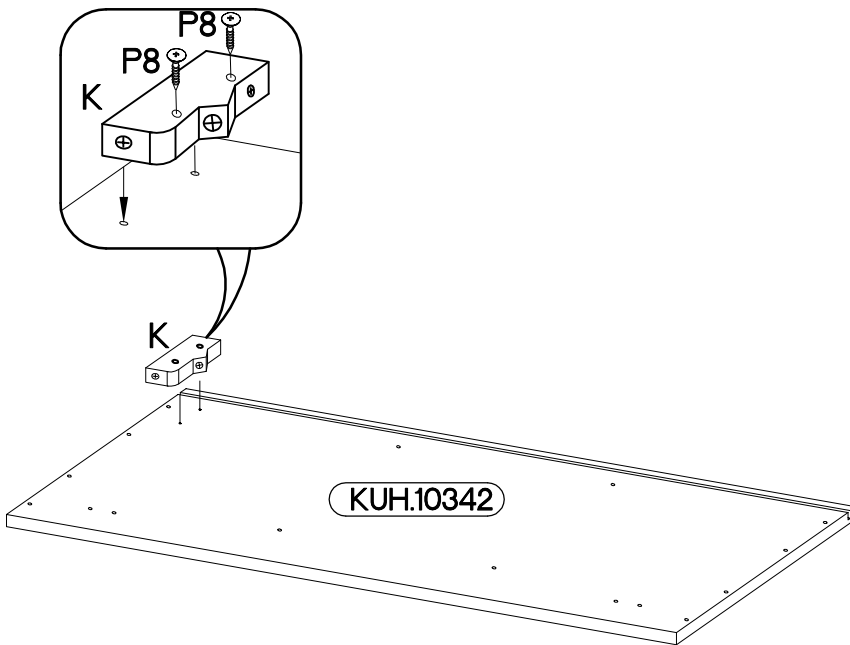
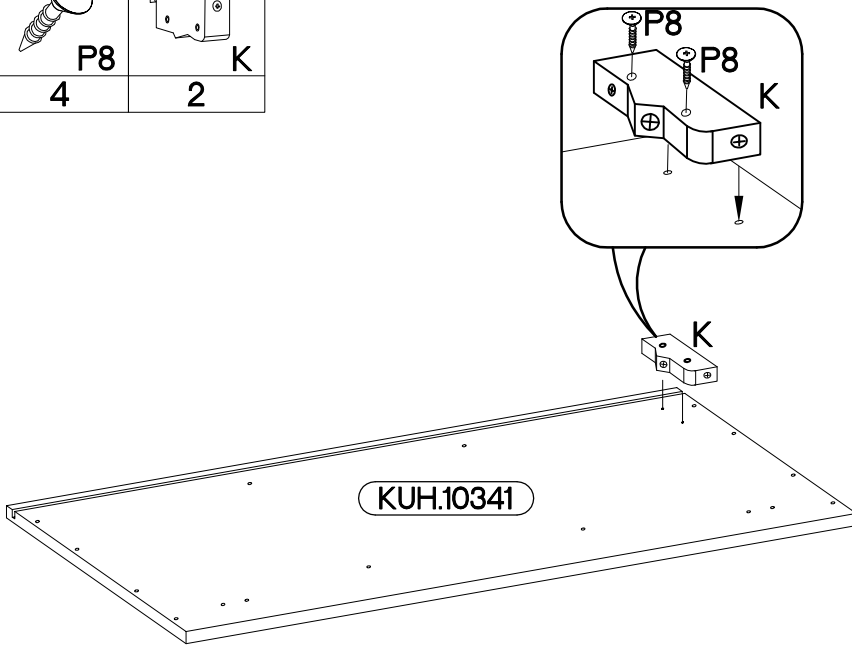
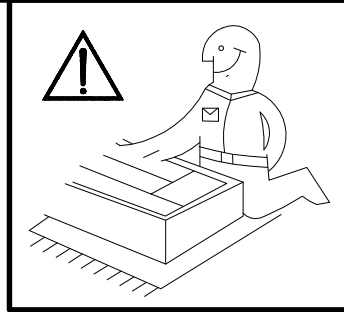

ISM-KUH-01150

 ±8x30mm A	 ±4.0x30mm P8	 K
8	4	2



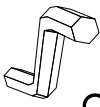

2

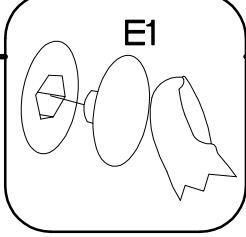
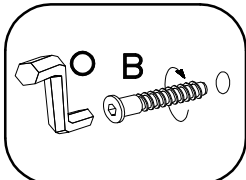
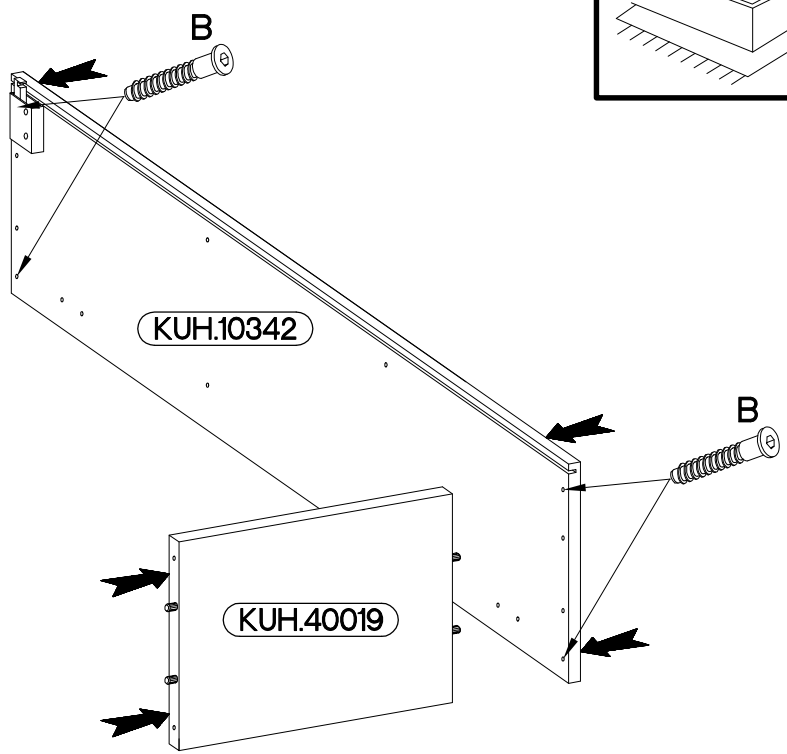
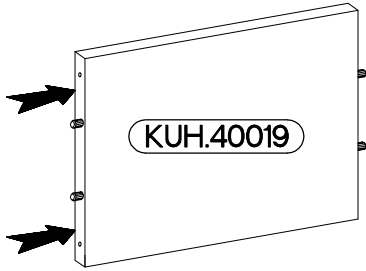
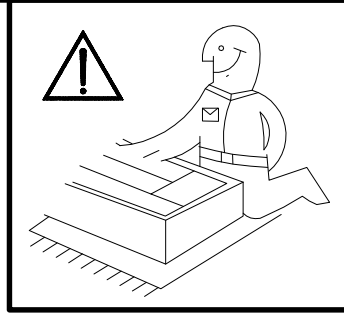
6,4 x 50mm		
		
<b>B</b>	<b>O</b>	<b>E1</b>
4	1	4

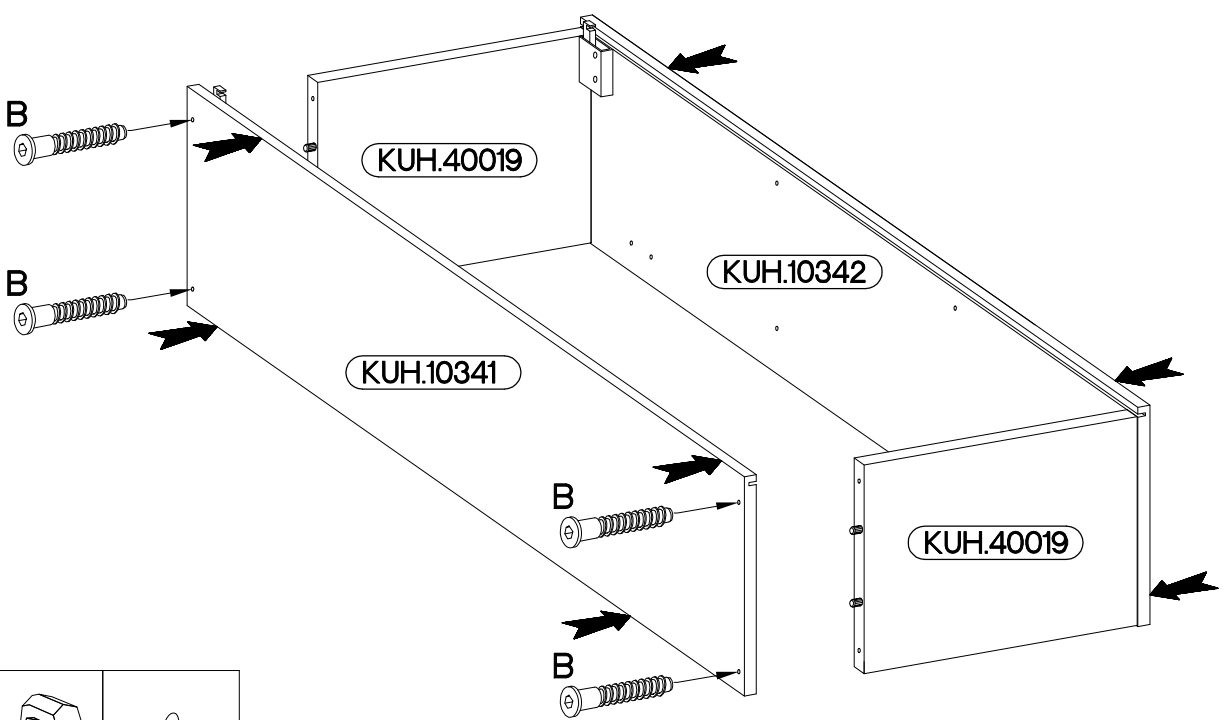

3

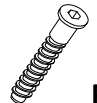
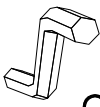

6,4 x 50mm		
		
<b>B</b>	<b>O</b>	<b>E1</b>
4	1	4

4

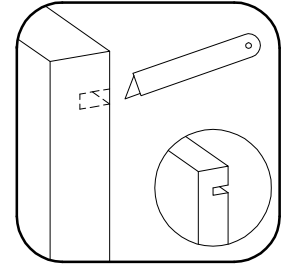
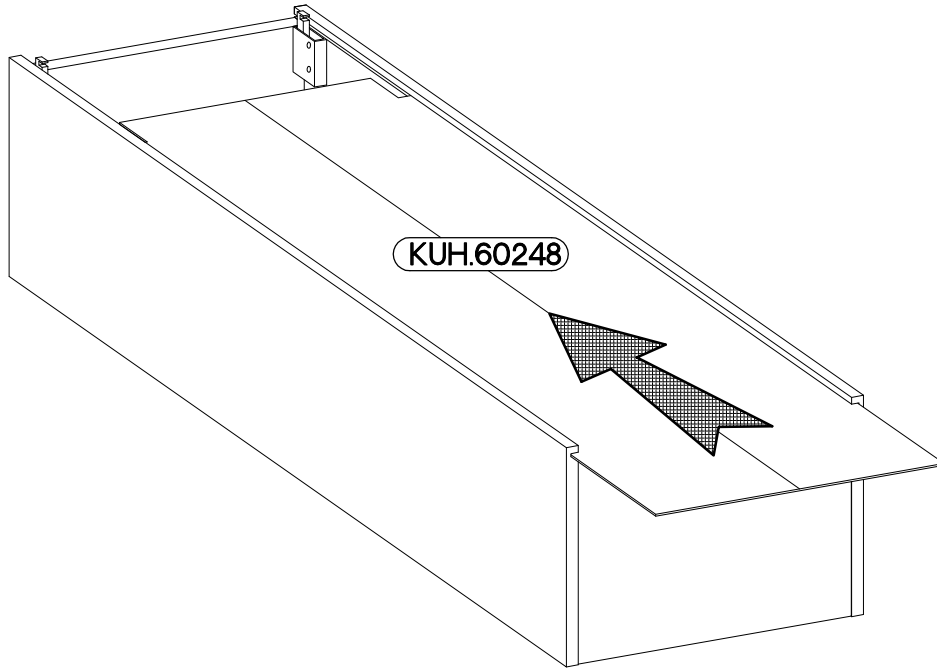
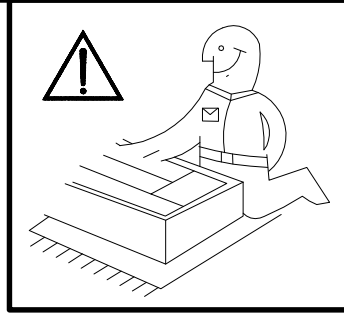

5

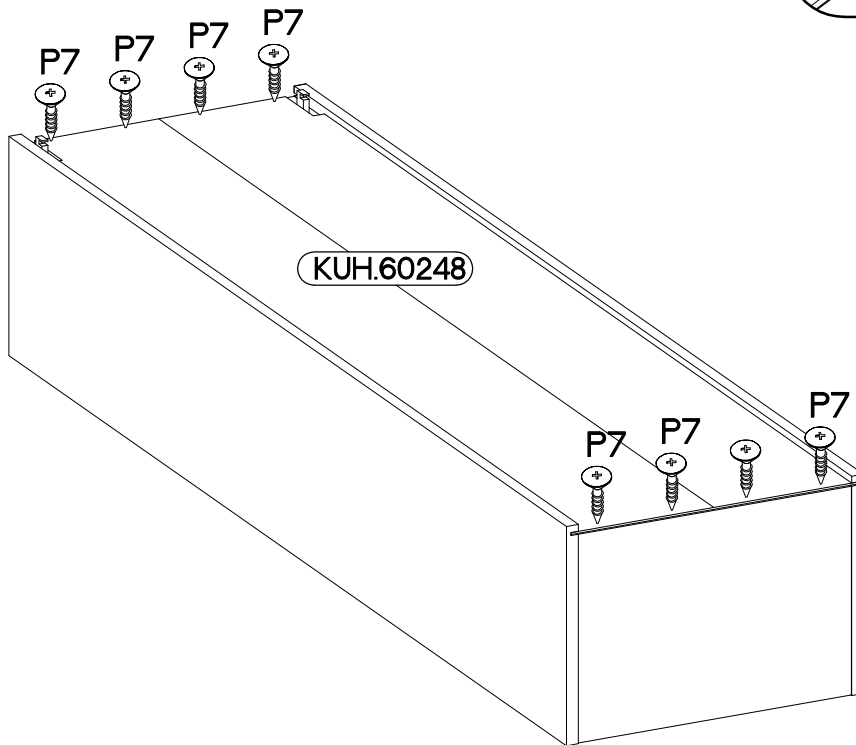
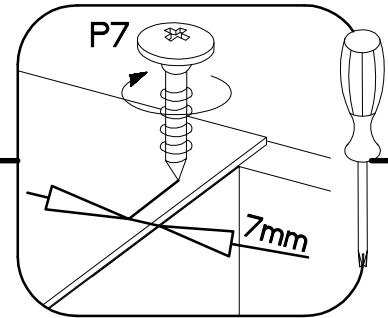
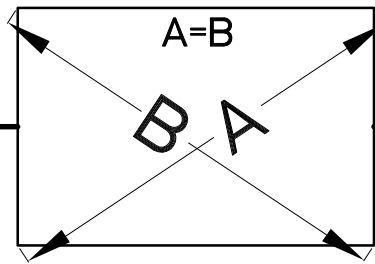
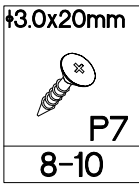

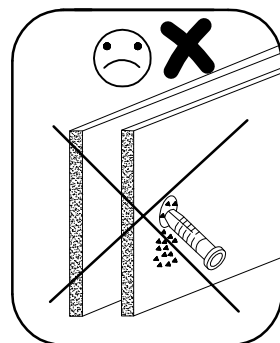
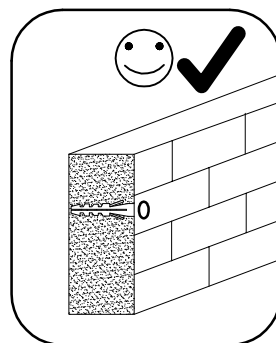
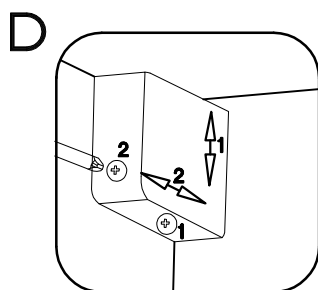
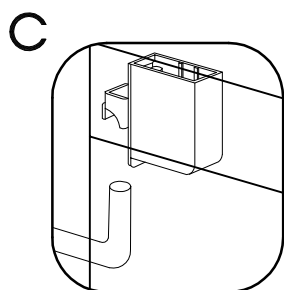
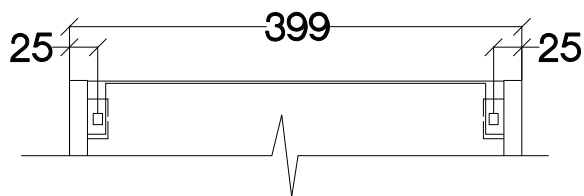
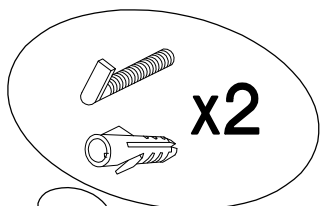
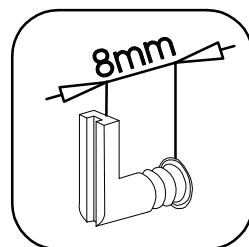
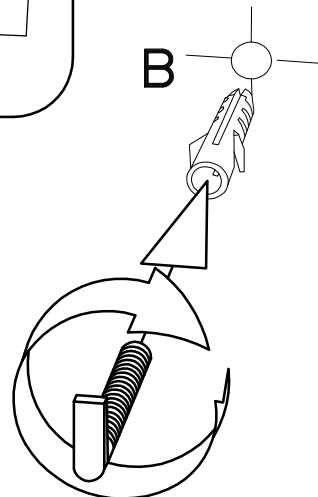
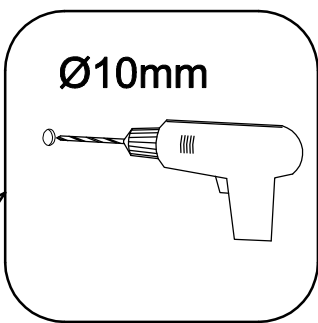
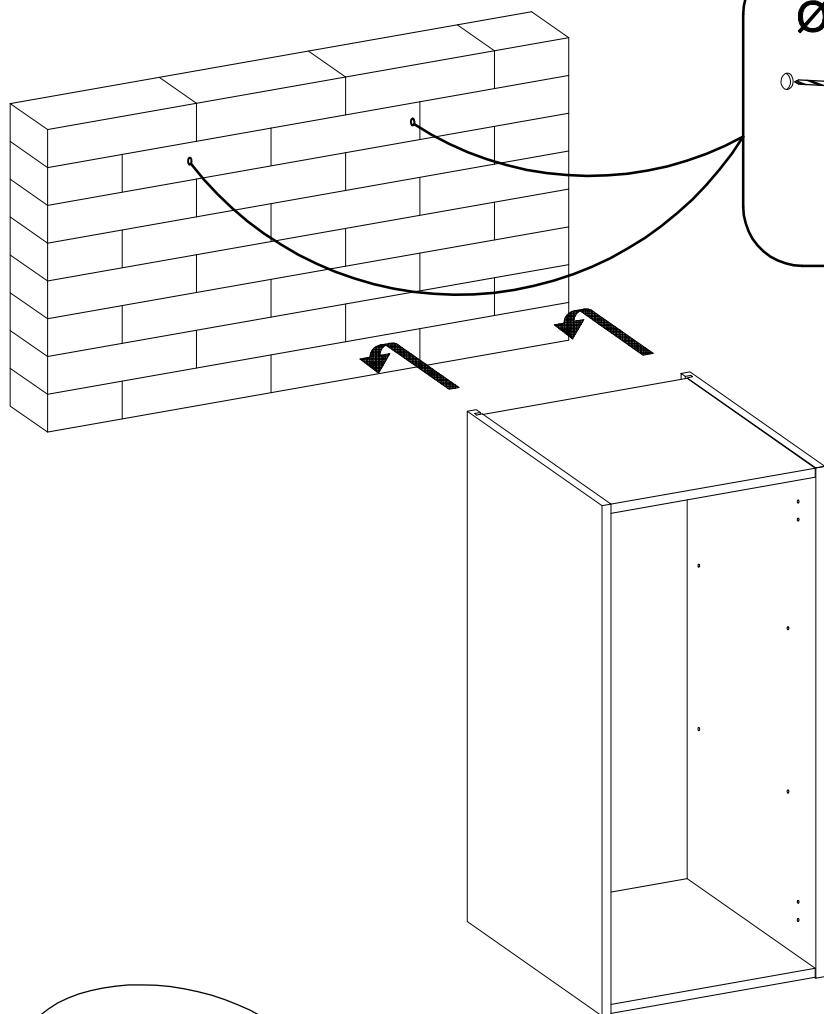
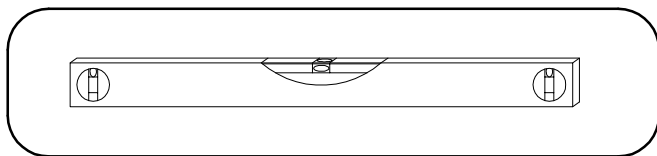

7

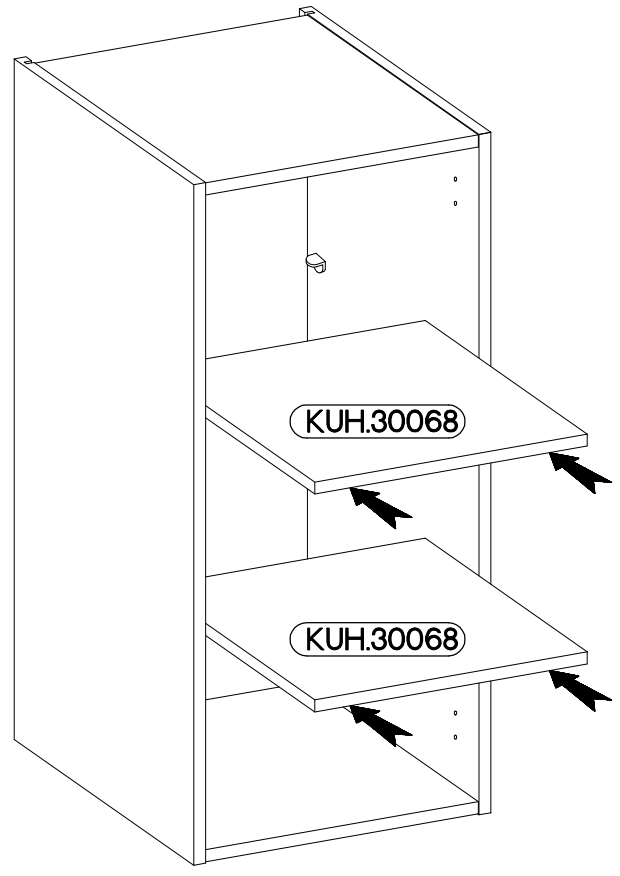
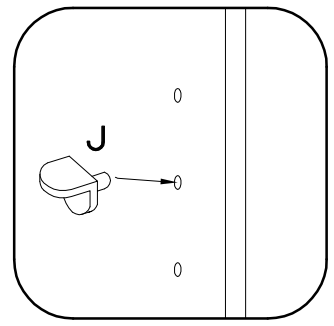
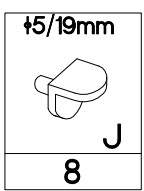

8

FRONT

