

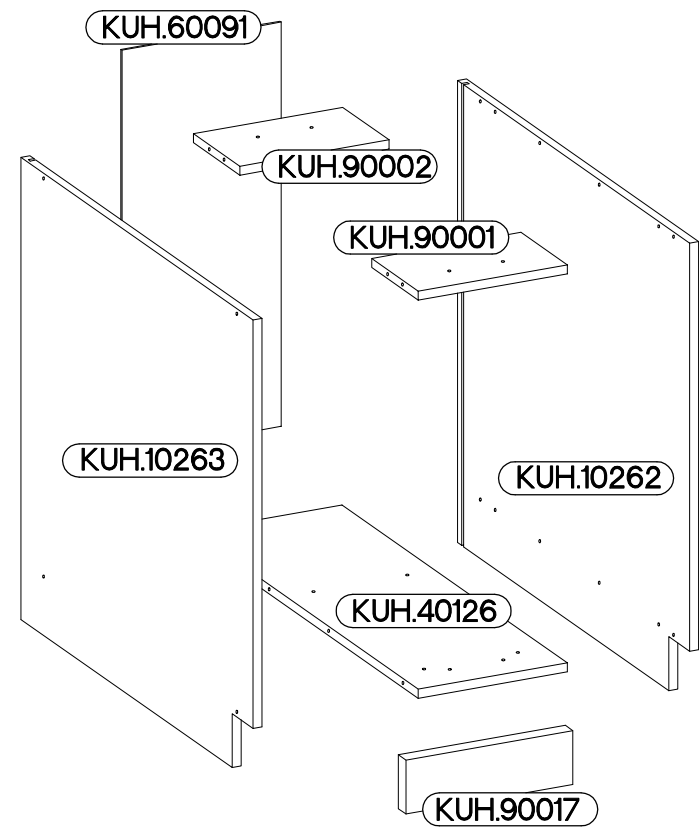

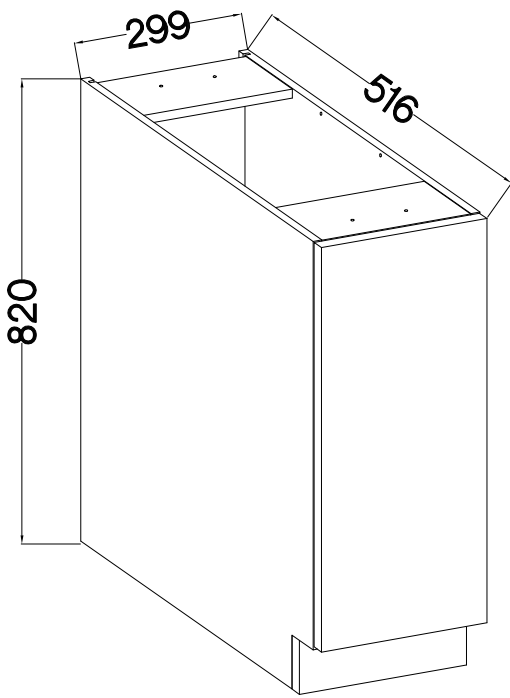

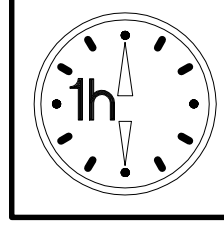

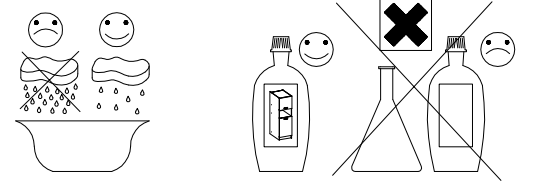
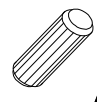

30 D CARGO BB



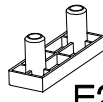
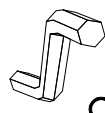

$\pm 8 \times 30 \text{mm}$ 	$6,4 \times 50 \text{mm}$ 
A 8	B 8

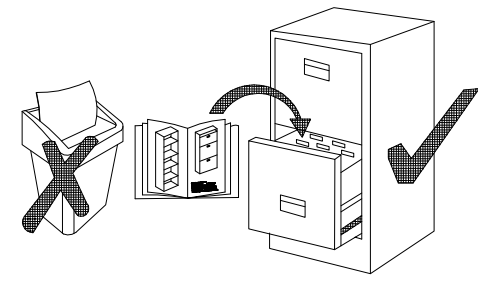
		$6.5 \times 48 \times 16$ 		$\pm 4.0 \times 45 \text{mm}$ 	$\pm 3.0 \times 20 \text{mm}$ 	$\pm 4.0 \times 35 \text{mm}$ 
E1 8	E9 2	F2 4	O 1	P4 2	P7 8-10	R3 4



ISM-KUH-01153

1

6.5x48x16  F2 4	†8x30mm  A 8
--	---

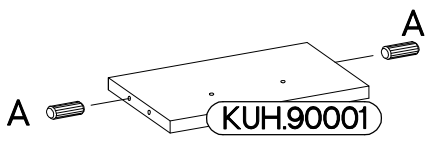
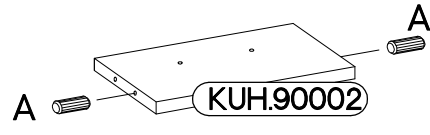
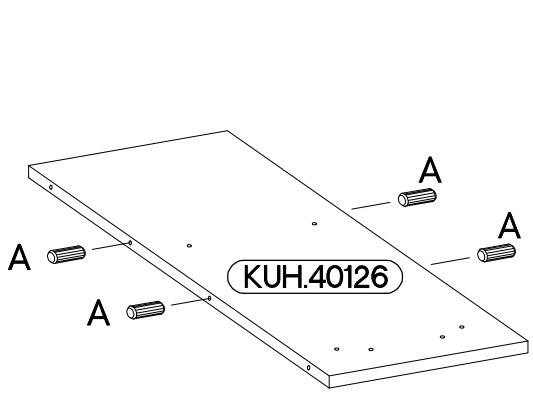
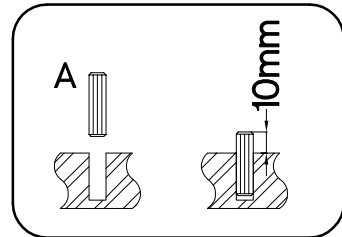
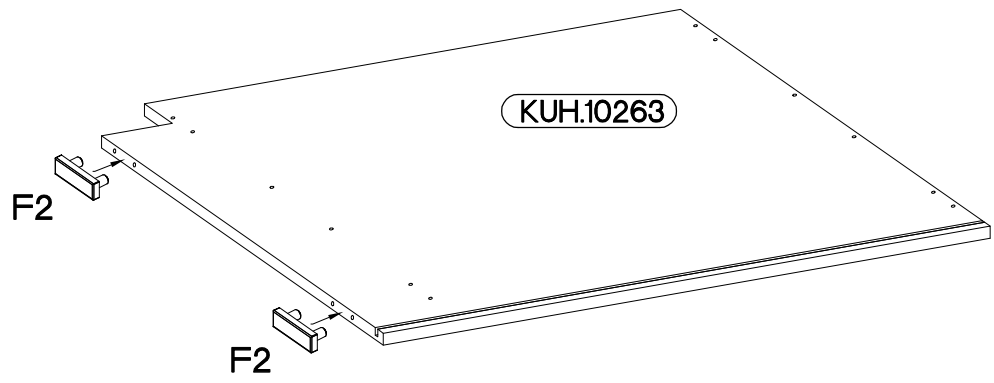
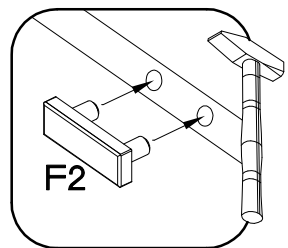
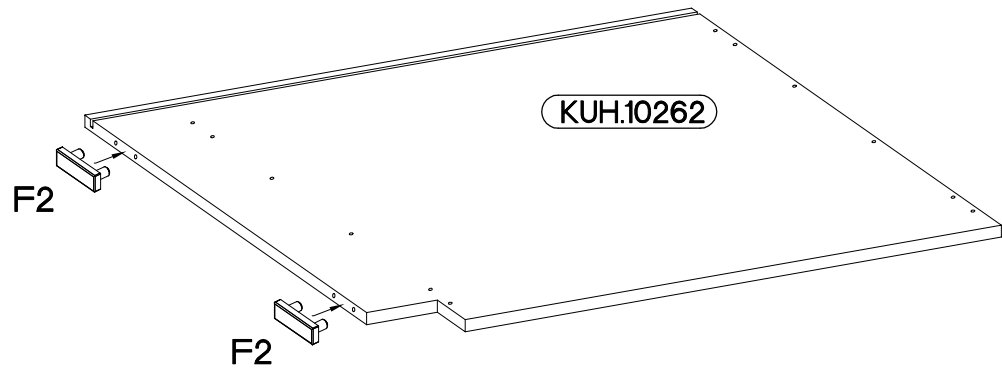
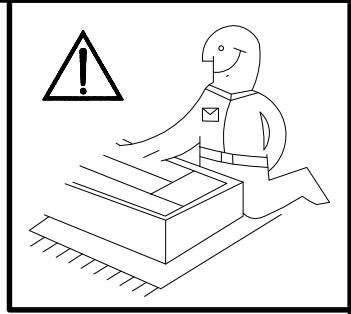

2

6,4 x 50mm

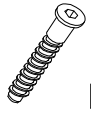

B

4

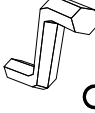

O

1



E1

4

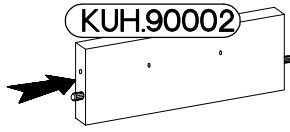

KUH.90002

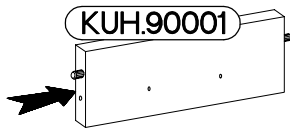

KUH.90001

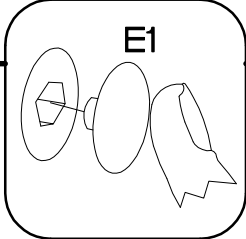
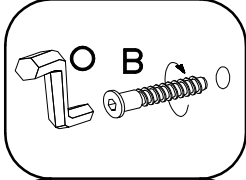
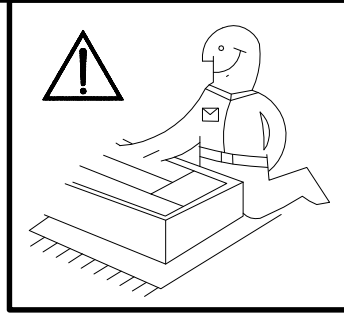
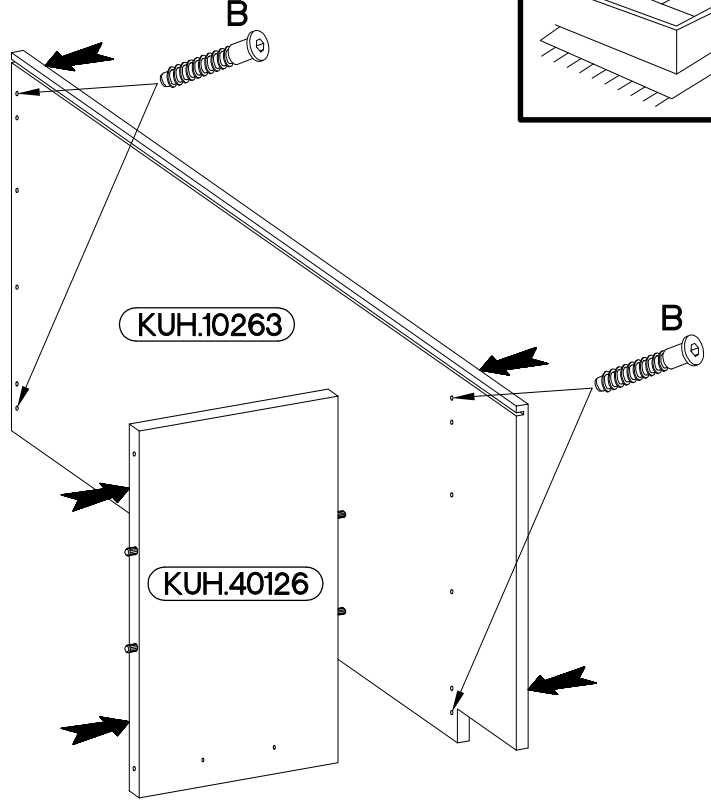

3

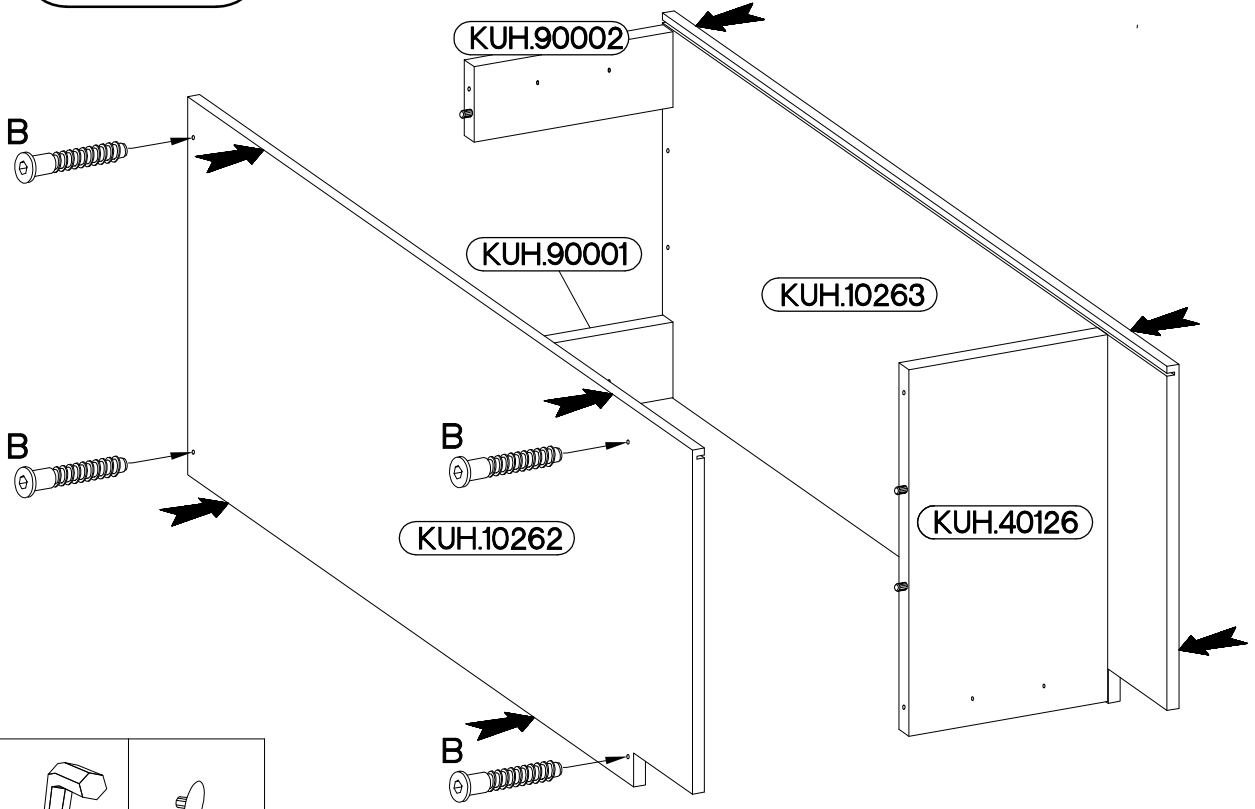

6,4 x 50mm

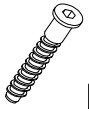

B

4

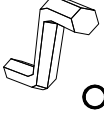

O

1



E1

4

4

1

4

4

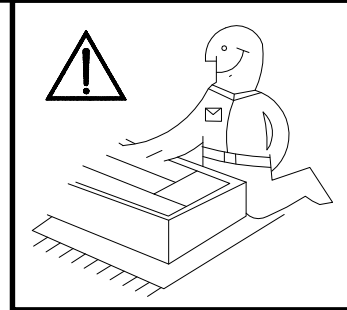
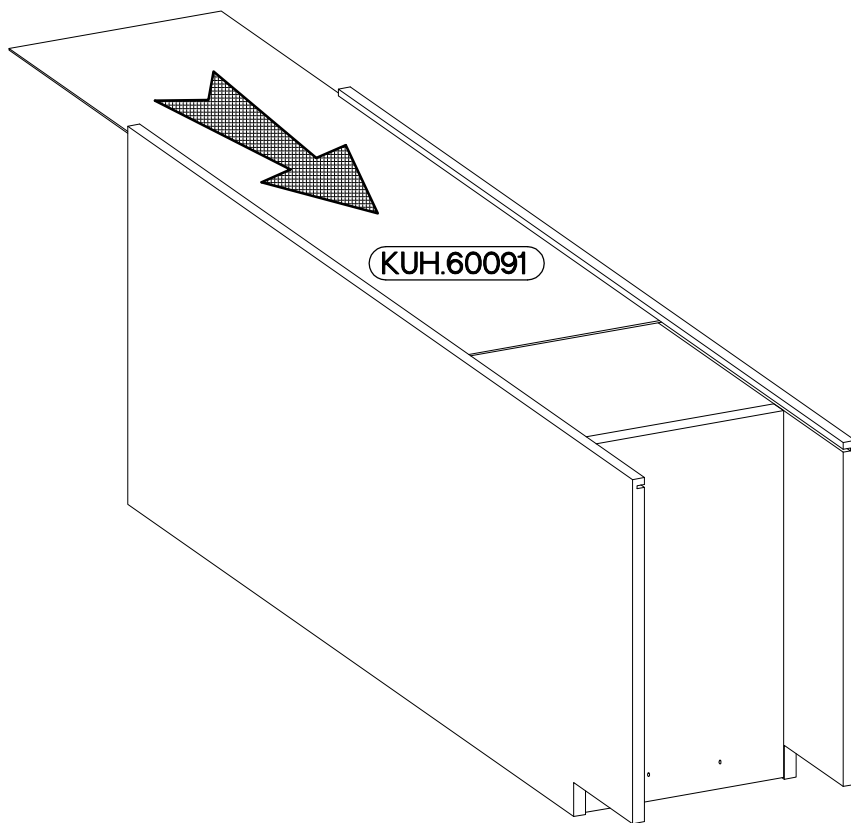

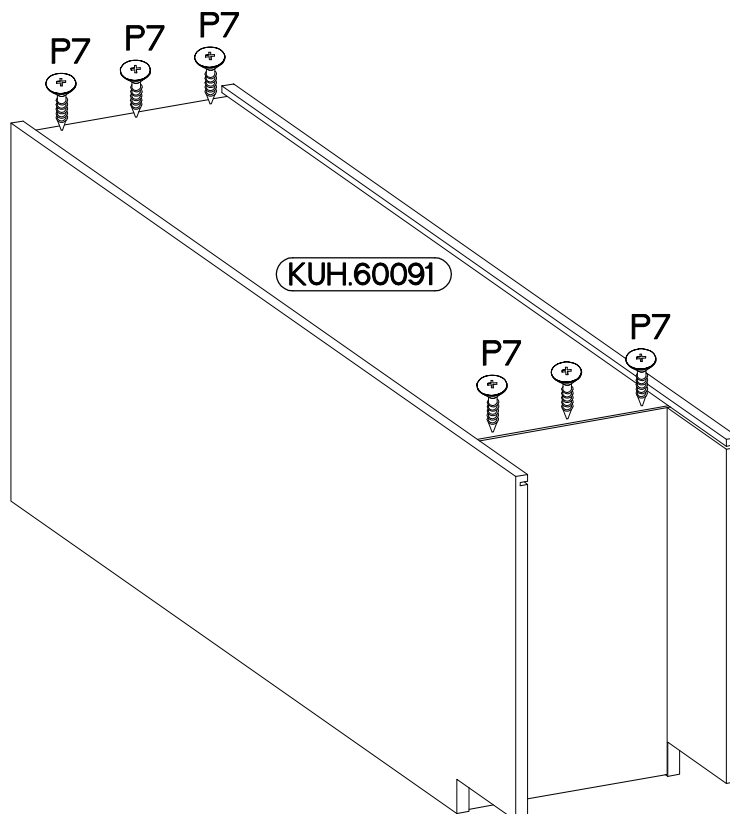
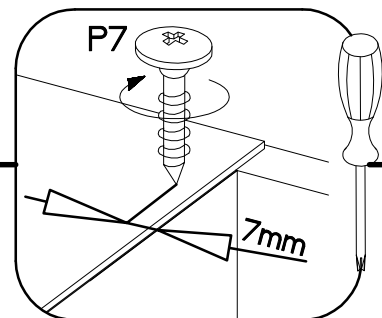
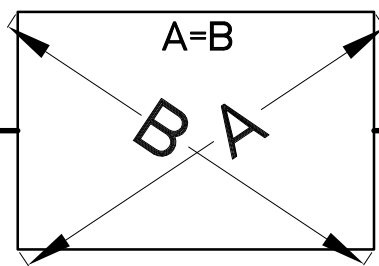

5

±3.0x20mm
P7
8-10



6

↑4.0x45mm  P4 2	 E9 2	↑4.0x35mm  R3 4
--	---	--

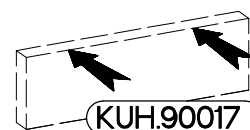
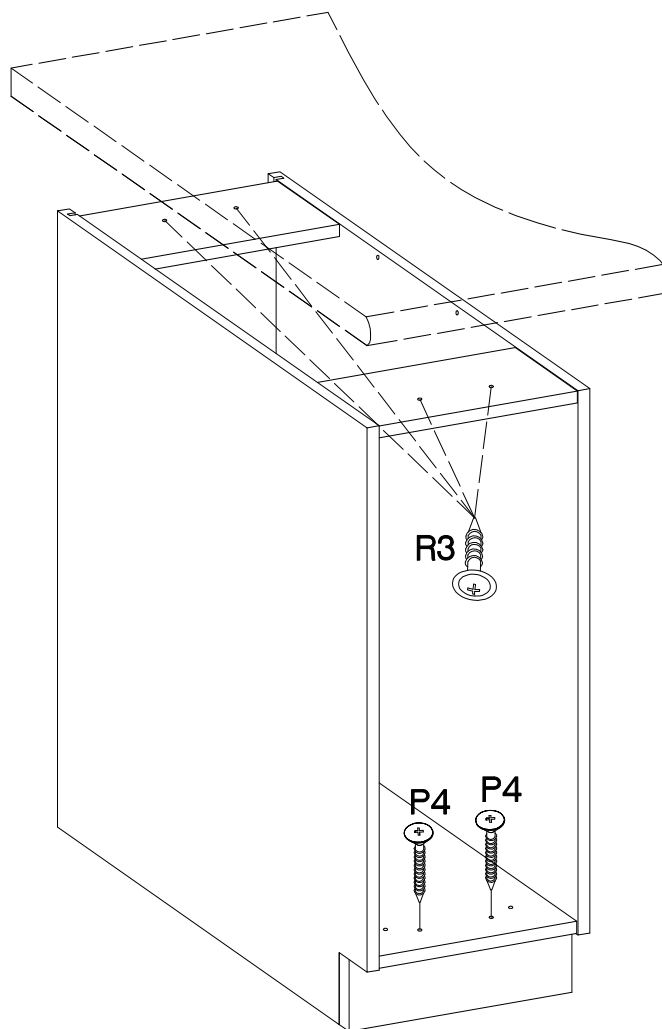
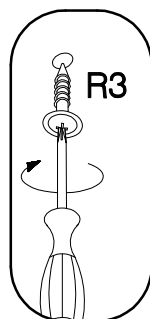
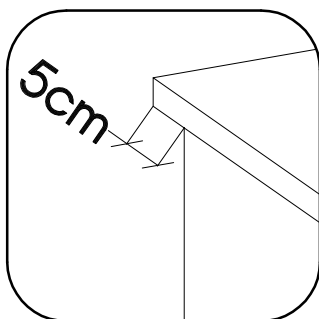
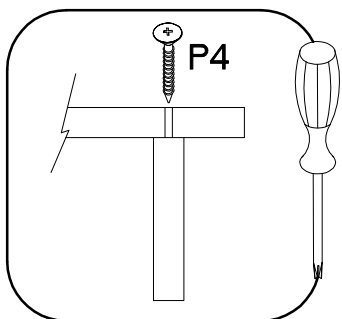

7

FRONT

