

Ø10mm  
30 G-90 1F

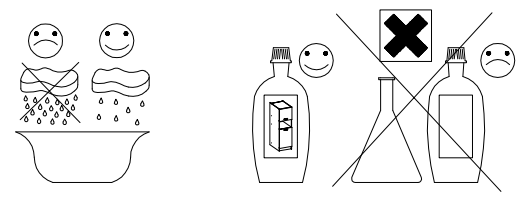

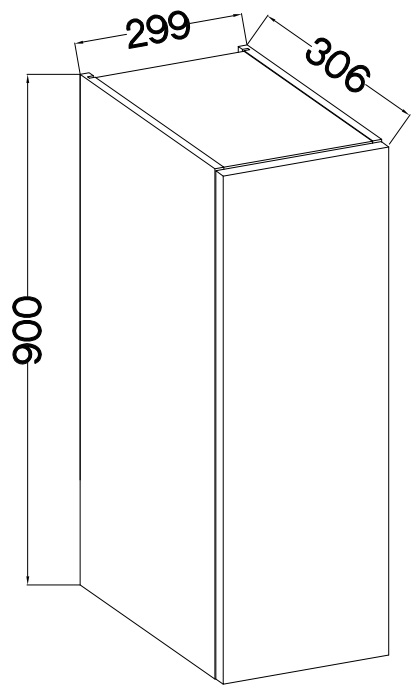

KUH.30012  
KUH.40018

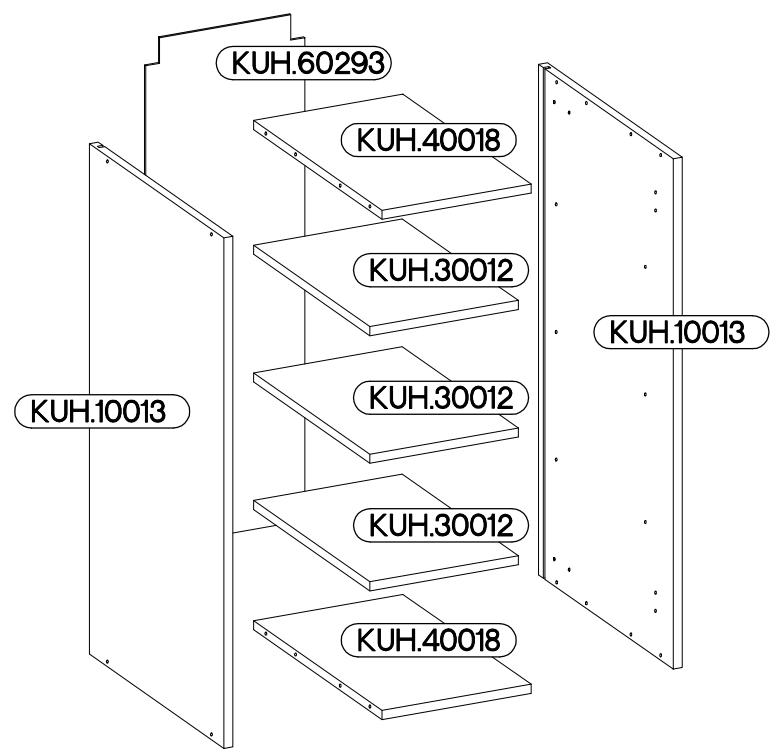
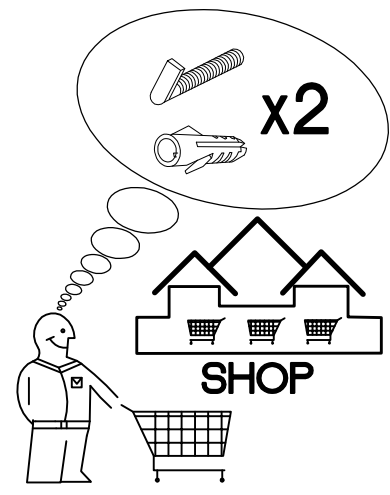
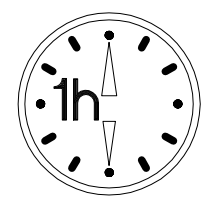

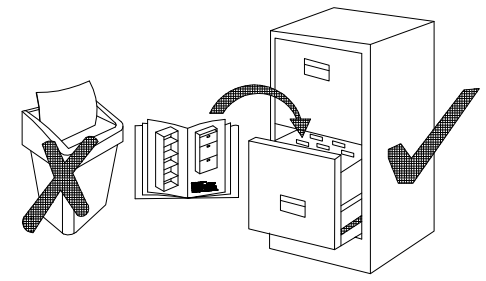
 <b>8x30mm</b> <b>A</b> <b>8</b>	 <b>6,4 x 50mm</b> <b>B</b> <b>8</b>	 <b>E1</b> <b>8</b>	 <b>HG</b> <b>2</b>	 <b>J</b> <b>12</b>	 <b>K</b> <b>2</b>	 <b>O</b> <b>1</b>	 <b>3.5x13mm</b> <b>P5</b> <b>4</b>	 <b>3.0x20mm</b> <b>P7</b> <b>8-10</b>	 <b>4.0x30mm</b> <b>P8</b> <b>4</b>
---	---	---------------------------	---------------------------	---------------------------	--------------------------	--------------------------	--	---	--



ISM-KUH-01172

 ø8x30mm A	 ø4.0x30mm P8	 K
8	4	2

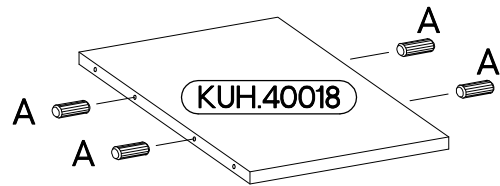
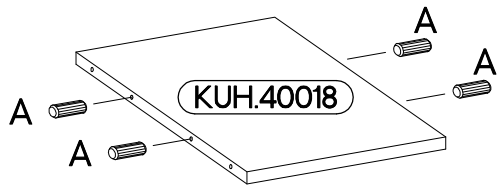
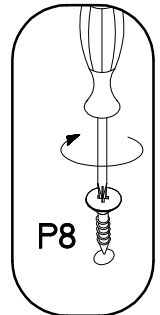
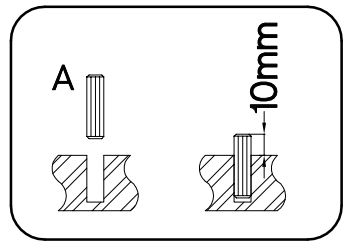
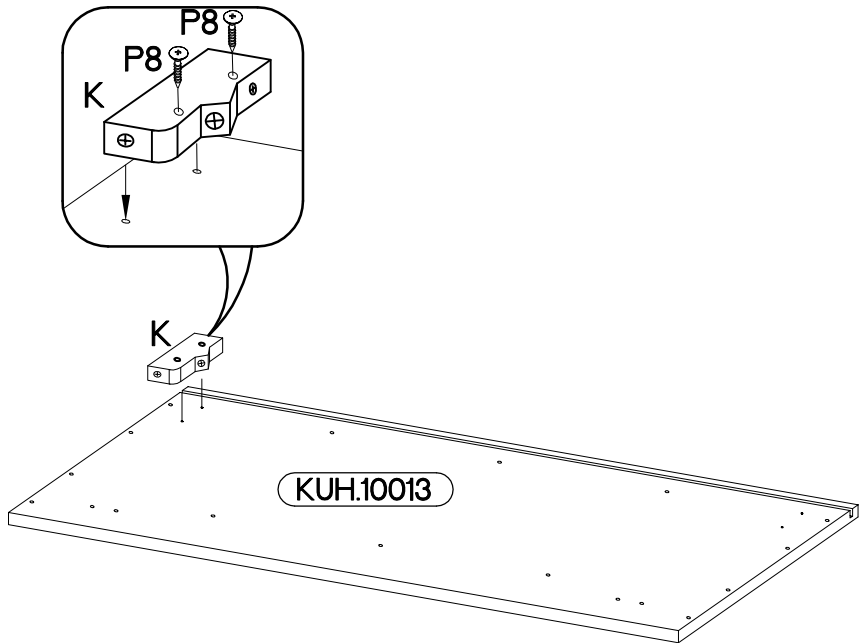
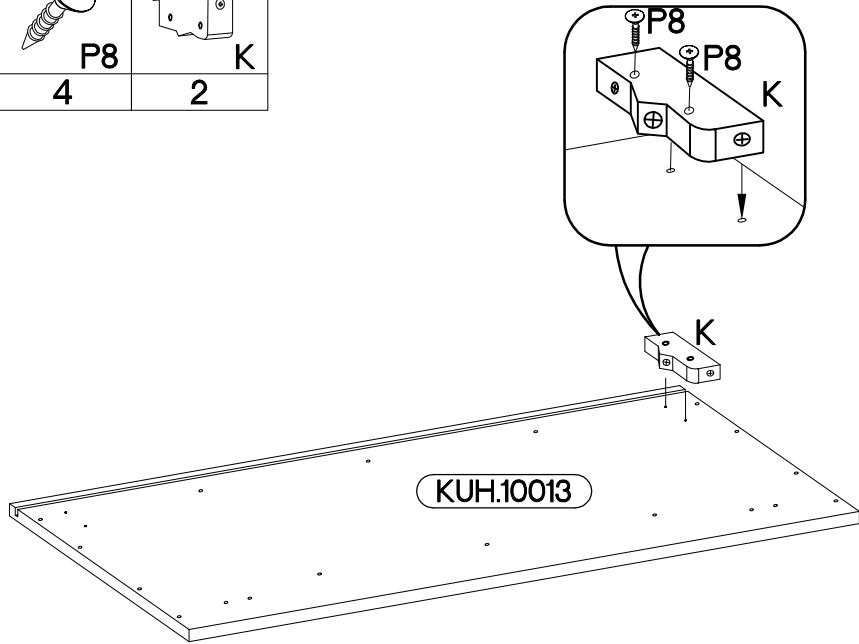
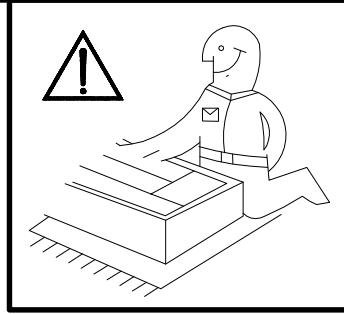

2

6,4 x 50mm

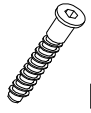

B

4

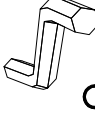

O

1



E1

4

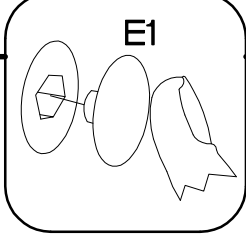
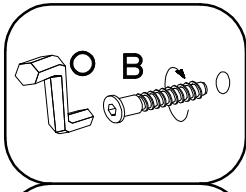
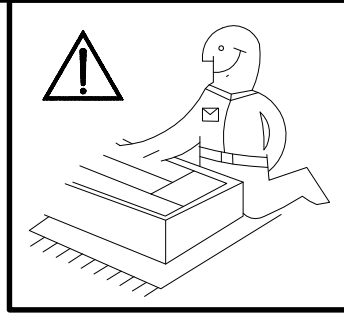
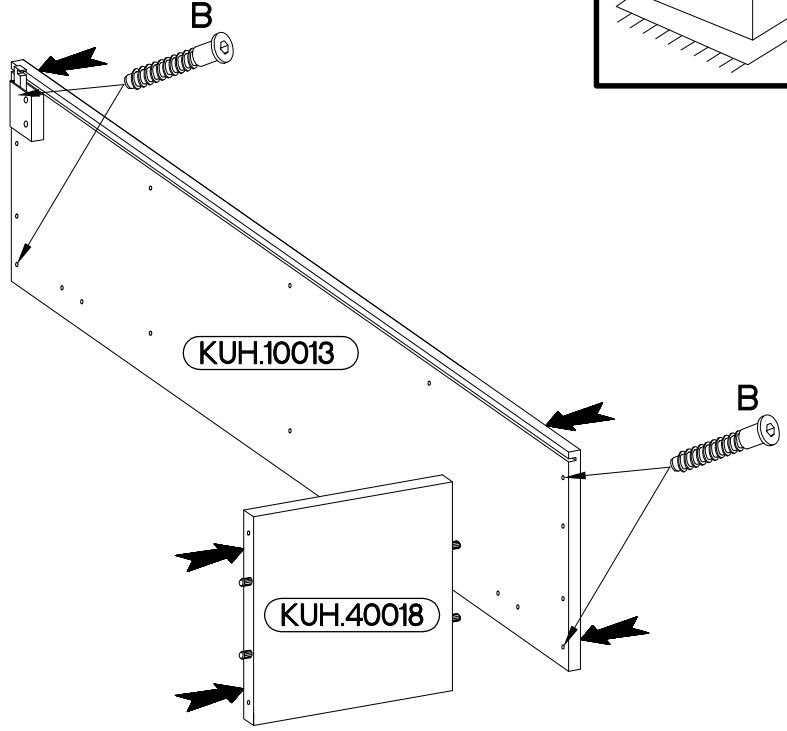
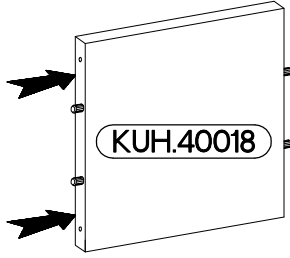

3

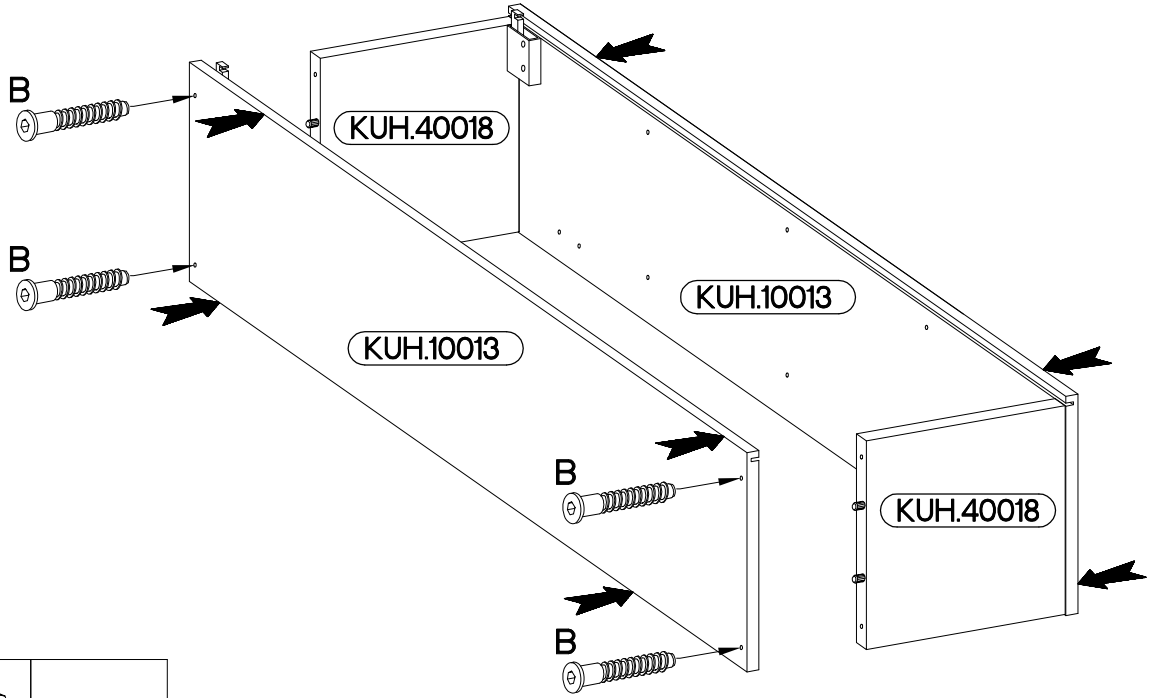

6,4 x 50mm

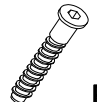

B

4

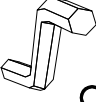

O

1



E1

4

4

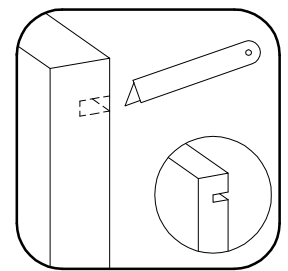
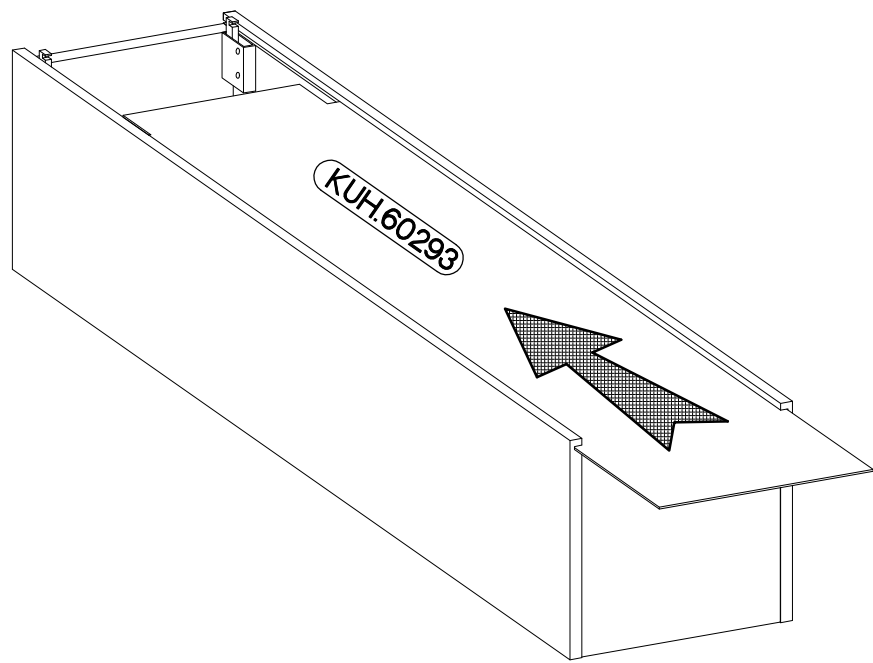
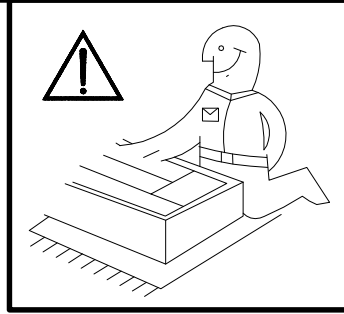

5

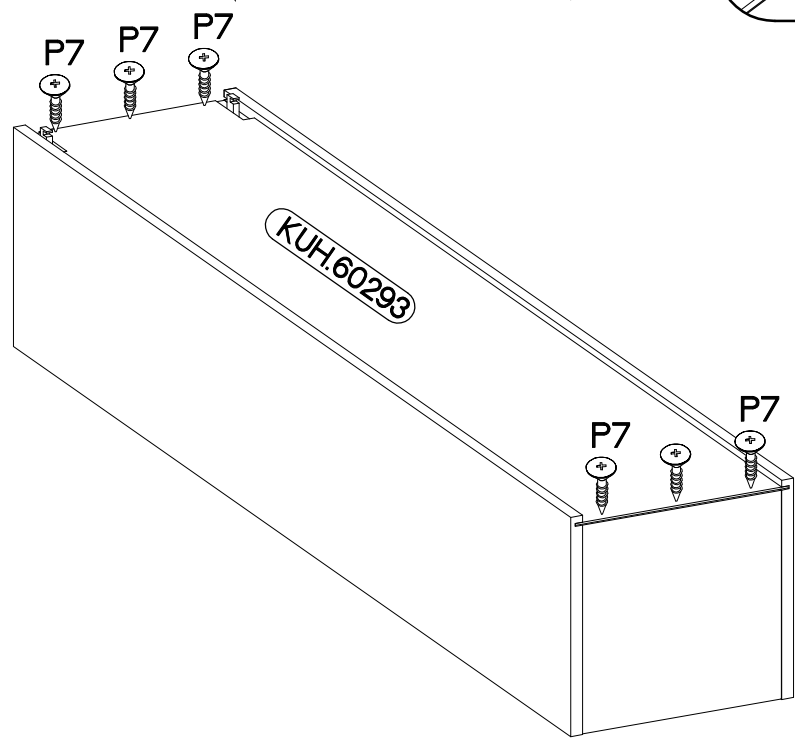
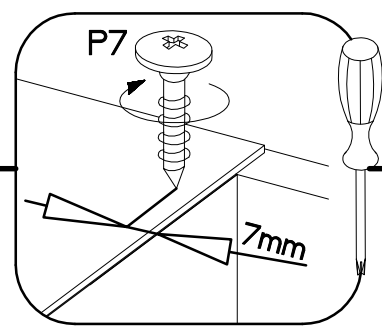
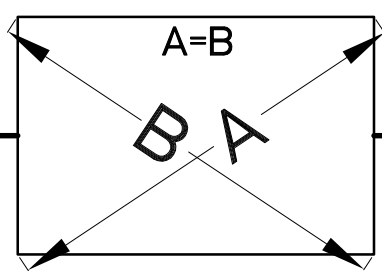
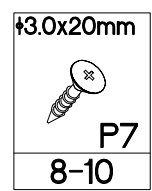

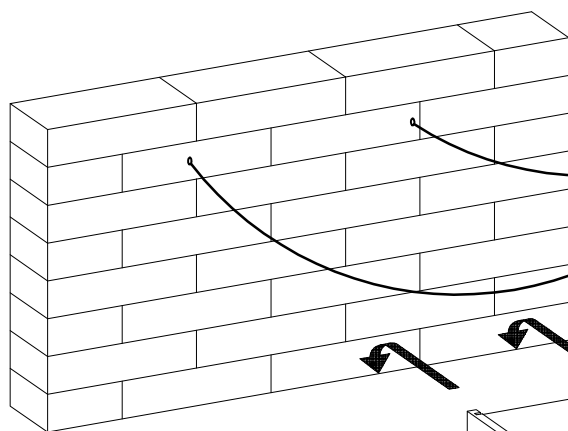
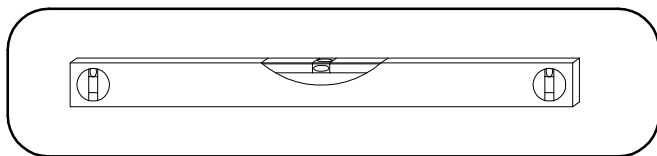

A

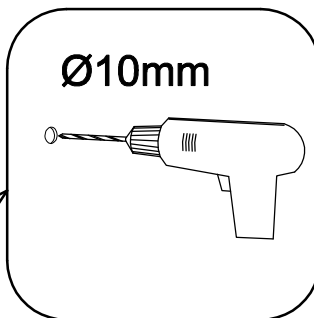

B

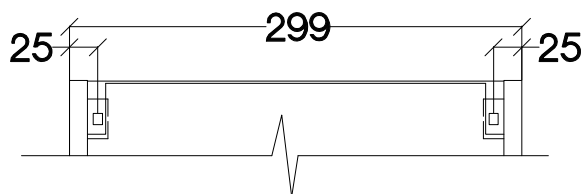
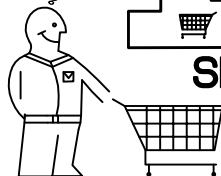
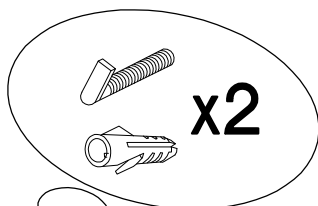
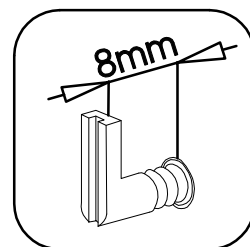
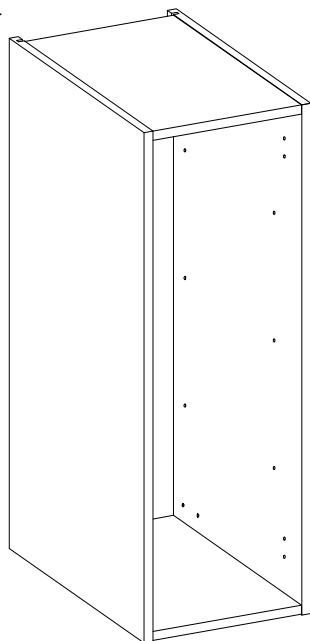
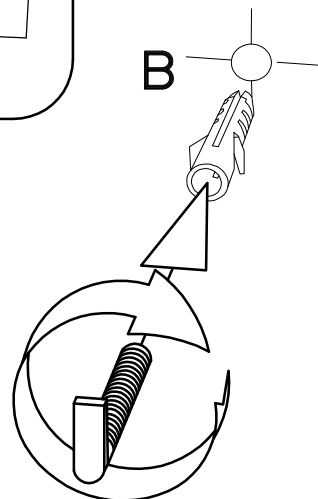

C

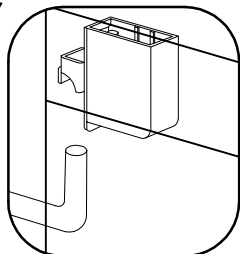

D

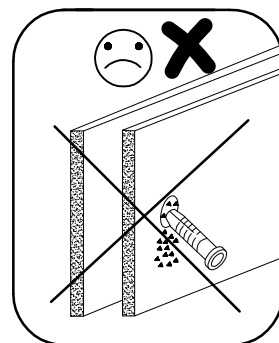
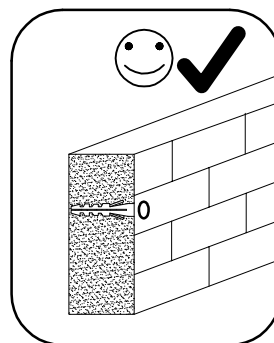
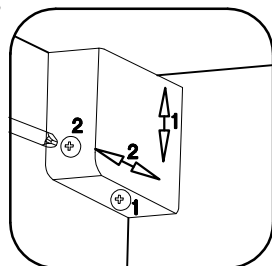

7

±5/19mm  
J  
12

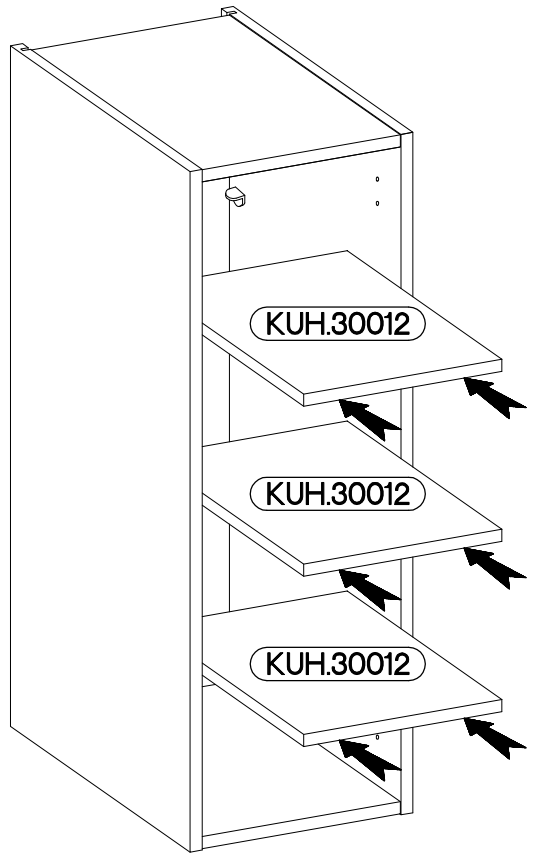
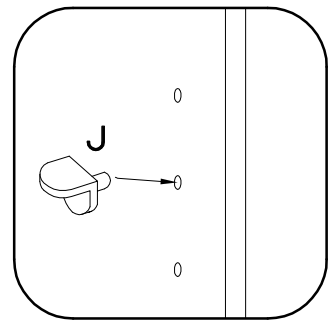

8

FRONT

