

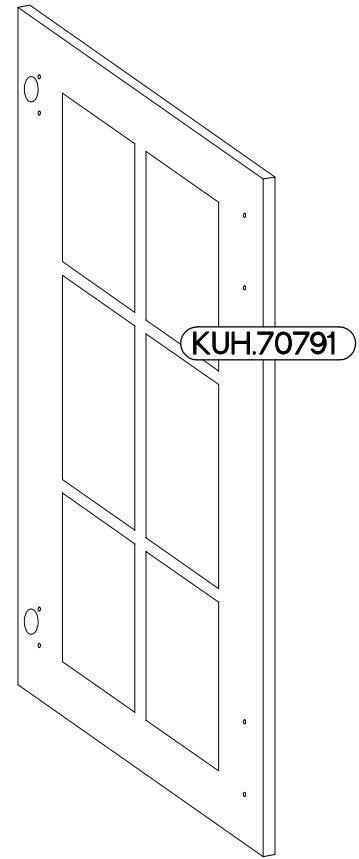

40 G-90 1F WS
FRONT

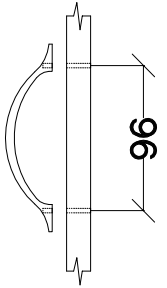
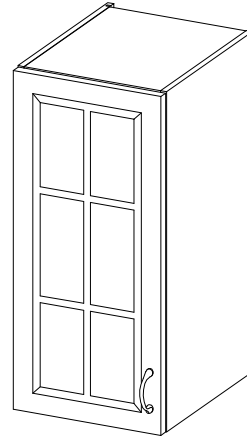
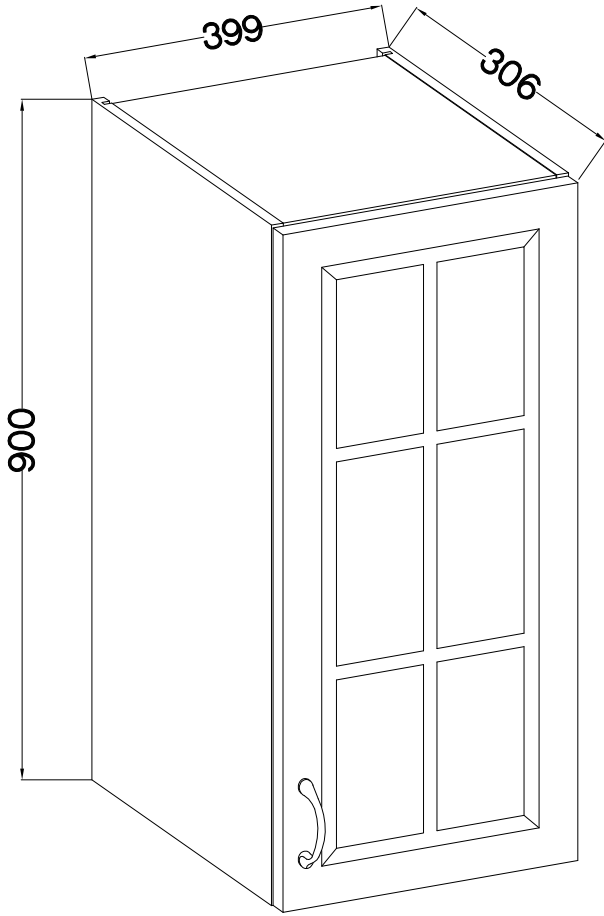

| | |
|--|---|
| M4x22mm | |
|  |  |
| U | S |
| 2 | 1 |

ISM-KUH-01209

1

LEFT

RIGHT

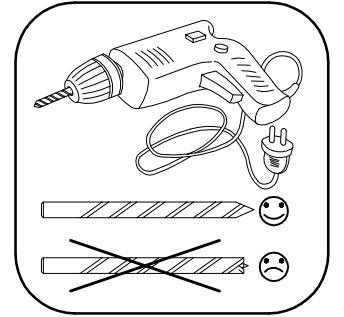
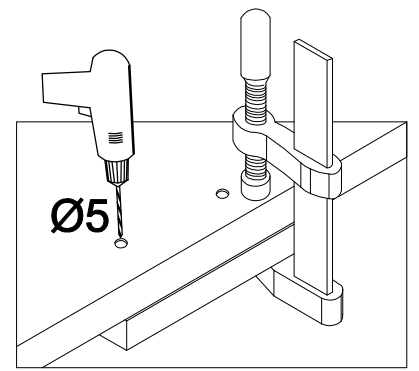
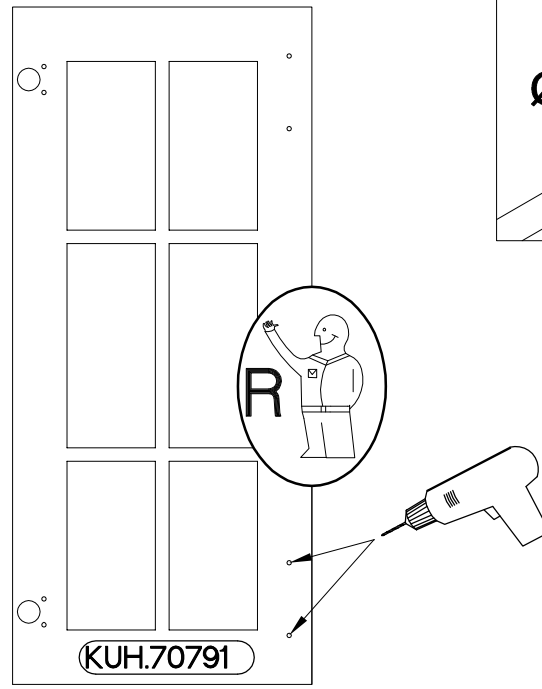
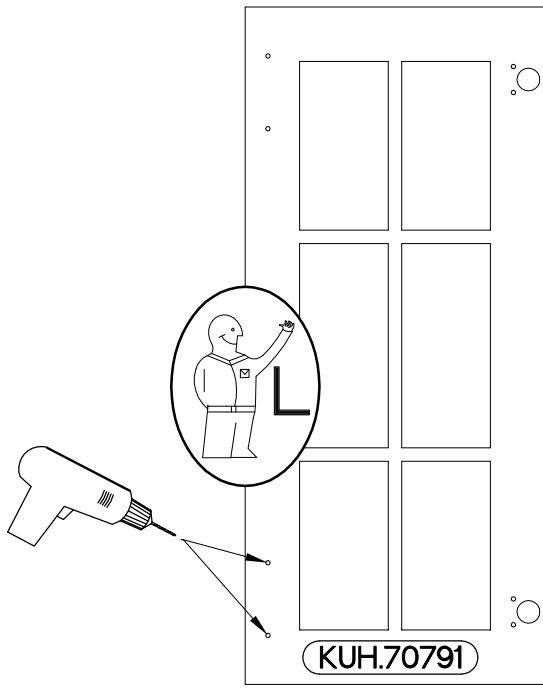

2

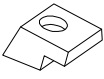
| | |
|--|-----------|
|  | ±3.0x16mm |
| J8 | P11 |
| 10 | 10 |

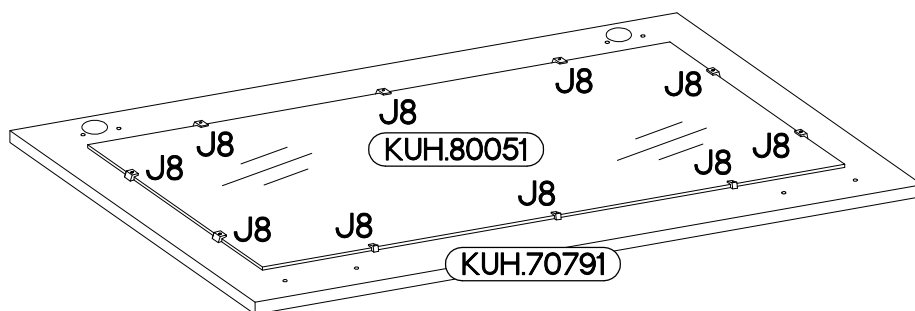
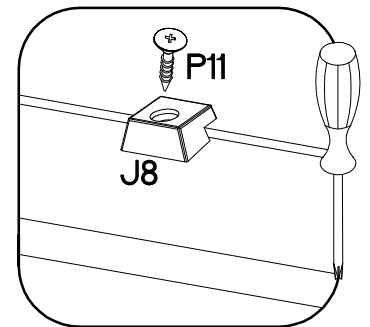
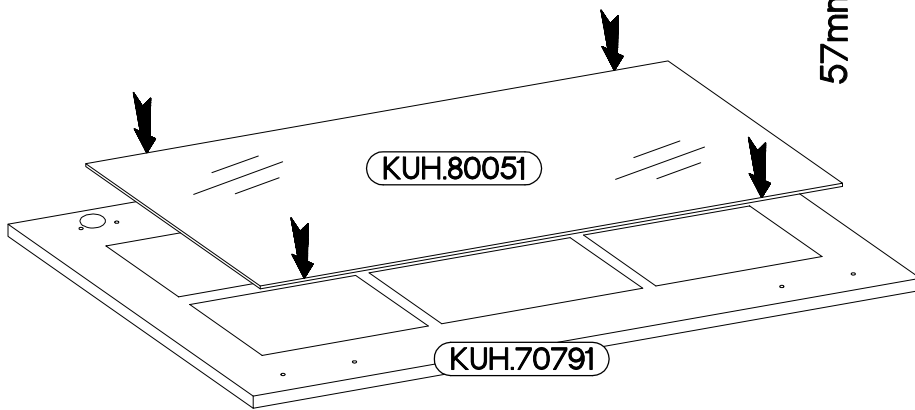
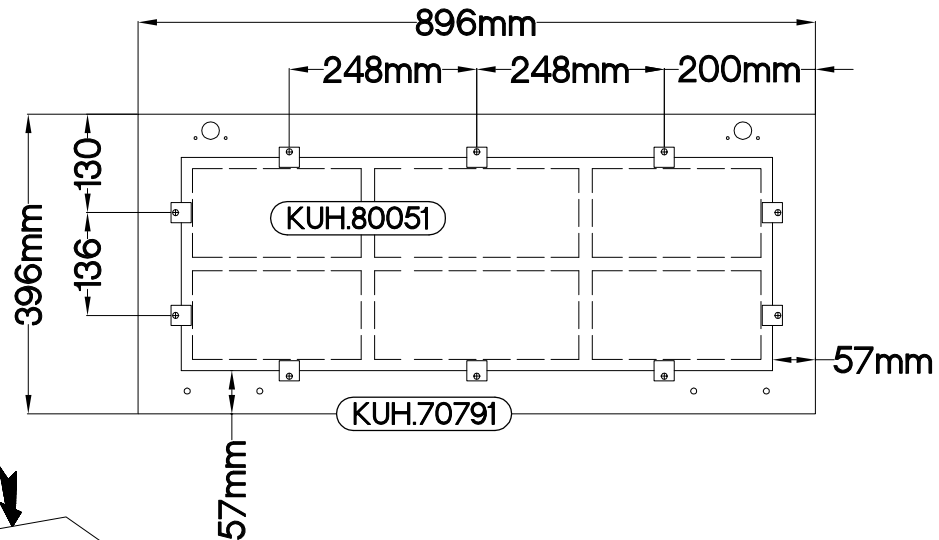

3

| | |
|--------------------|----------------------|
| +35/0mm HG 2 | +3.5x13mm P5 4 |
|--------------------|----------------------|

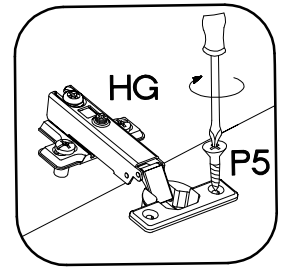
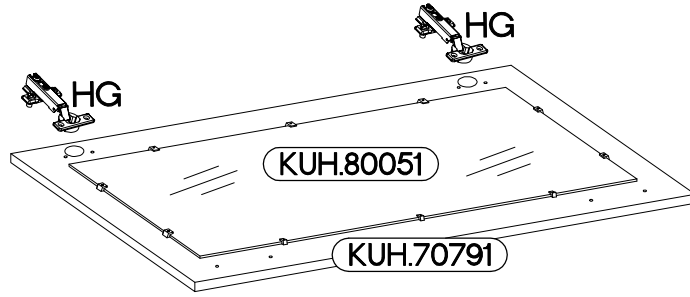

4

| | |
|-------------------|--------|
| M4x22mm U 2 | S 1 |
|-------------------|--------|

