

40 DK-2100 2F

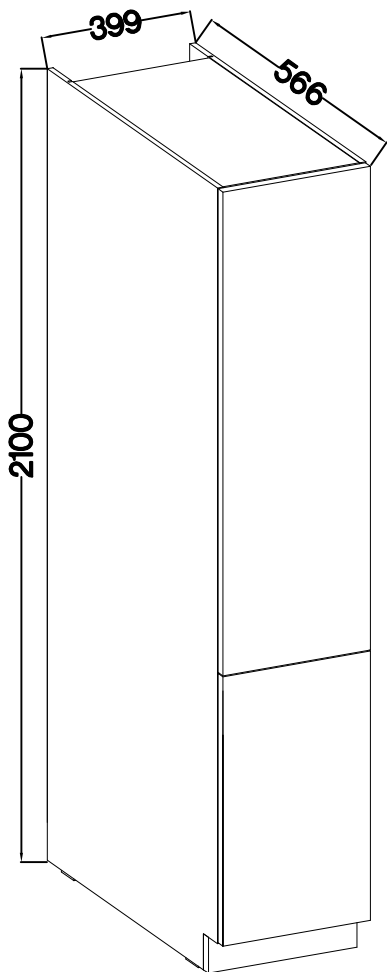

max. 10kg  
 KUH.30009  
 KUH.40025  
 KUH.40026

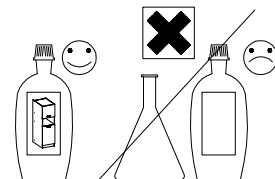
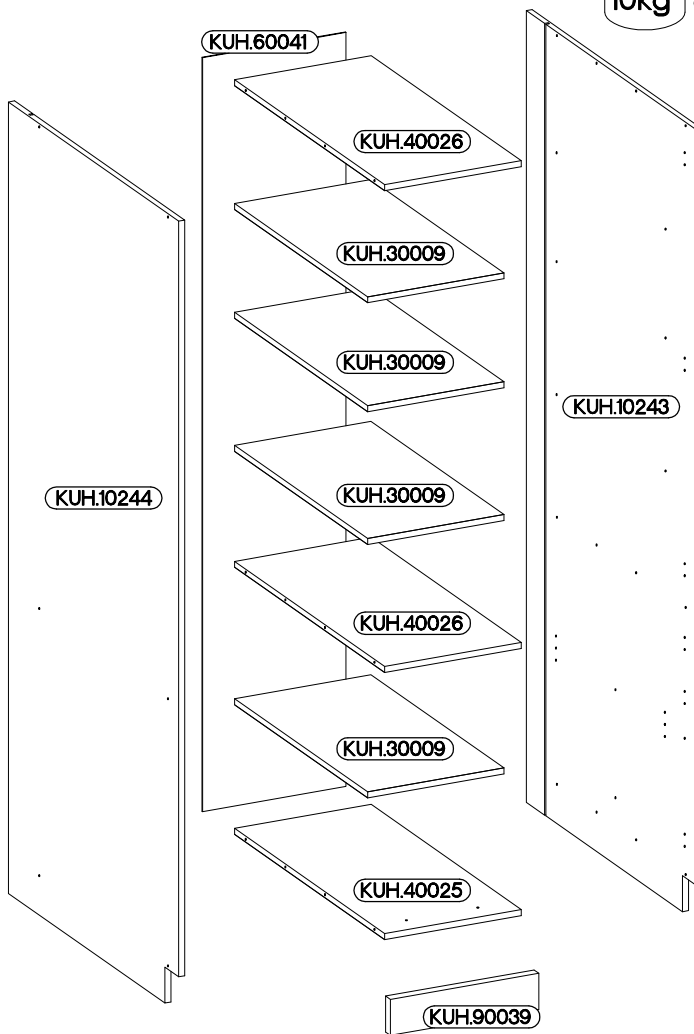

|                                     |   |                     |                    |  |   |
|-------------------------------------|---|---------------------|--------------------|--|---|
| <br><b>8x30mm</b><br><b>A</b><br>12 | <br><b>6,4 x 50mm</b><br><b>B</b><br>12   | <br><b>E1</b><br>12 | <br><b>E9</b><br>2 | <br><b>6.5x48x16</b><br><b>F2</b><br>4     | <br><b>+35/0mm</b><br><b>[CD] HG</b><br>5 |
| <br><b>J</b><br>16                  | <br><b>120x30x15mm</b><br><b>L25</b><br>1 |                     | <br><b>O</b><br>1  | <br><b>+4.0x45mm</b><br><b>P4</b><br>2     | <br><b>+3.5x13mm</b><br><b>P5</b><br>12   |
|                                     |   |                     |                    | <br><b>+3.0x20mm</b><br><b>P7</b><br>10-15 |   |

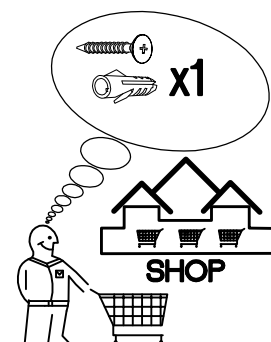

ISM-KUH-01614

# 1

6.5x48x16

+8x30mm

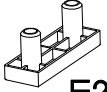

F2

4



A

12

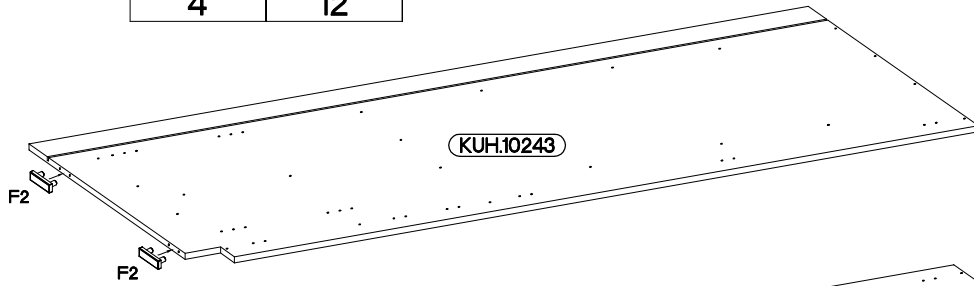
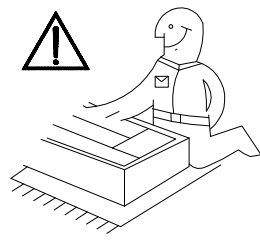

KUH.10243

F2

F2

F2

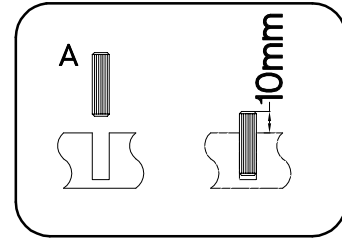

A

10mm

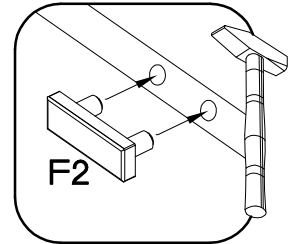

F2

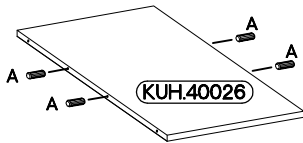

KUH.40026

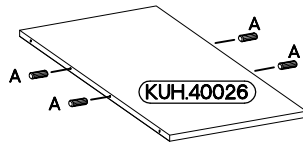

KUH.40026

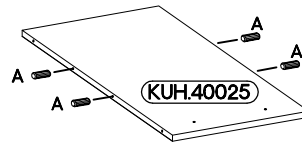

KUH.40025

# 2

6,4 x 50mm



B

6

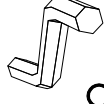

O

1



E1

6

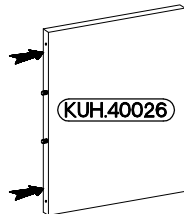

KUH.40026

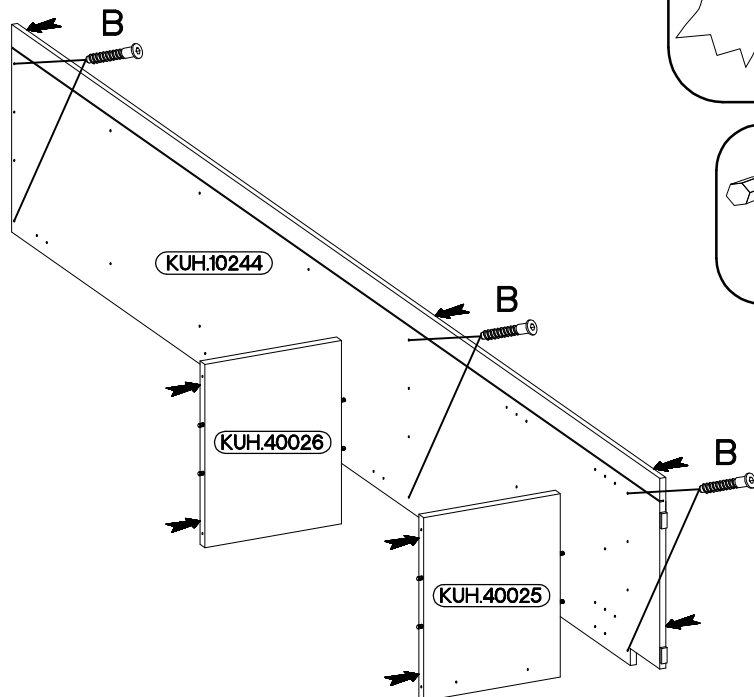

KUH.10244

KUH.40026

KUH.40025

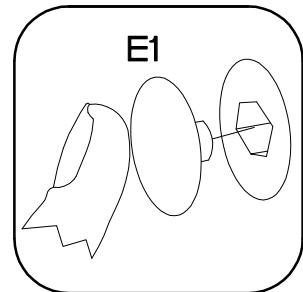

E1

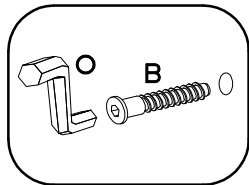

O

B

3

6,4 x 50mm



6

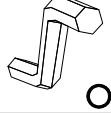

1

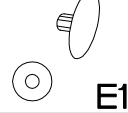

6

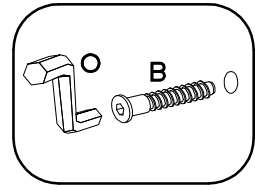
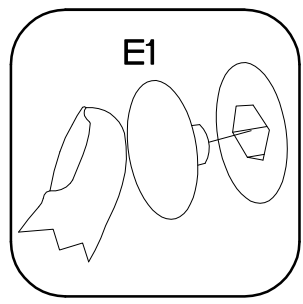
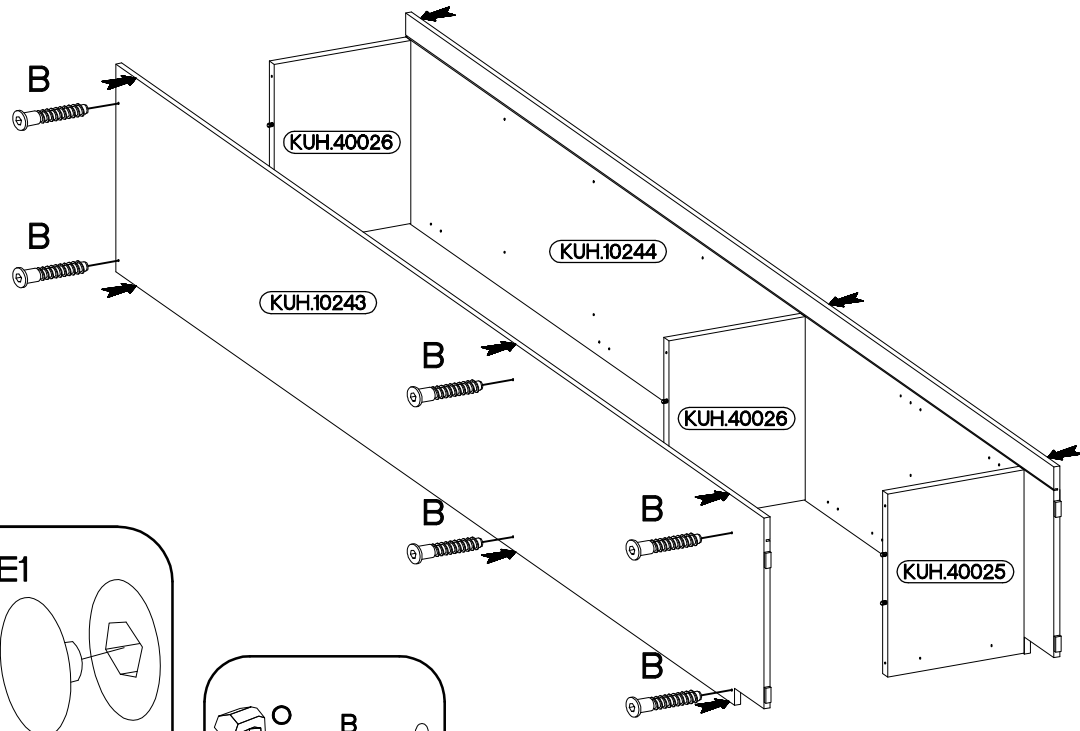
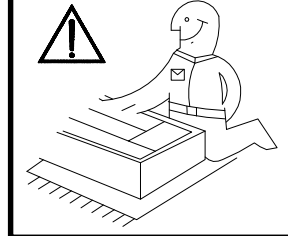

4

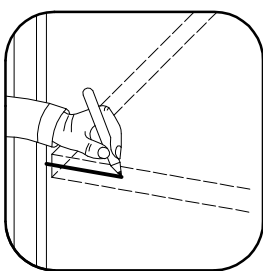
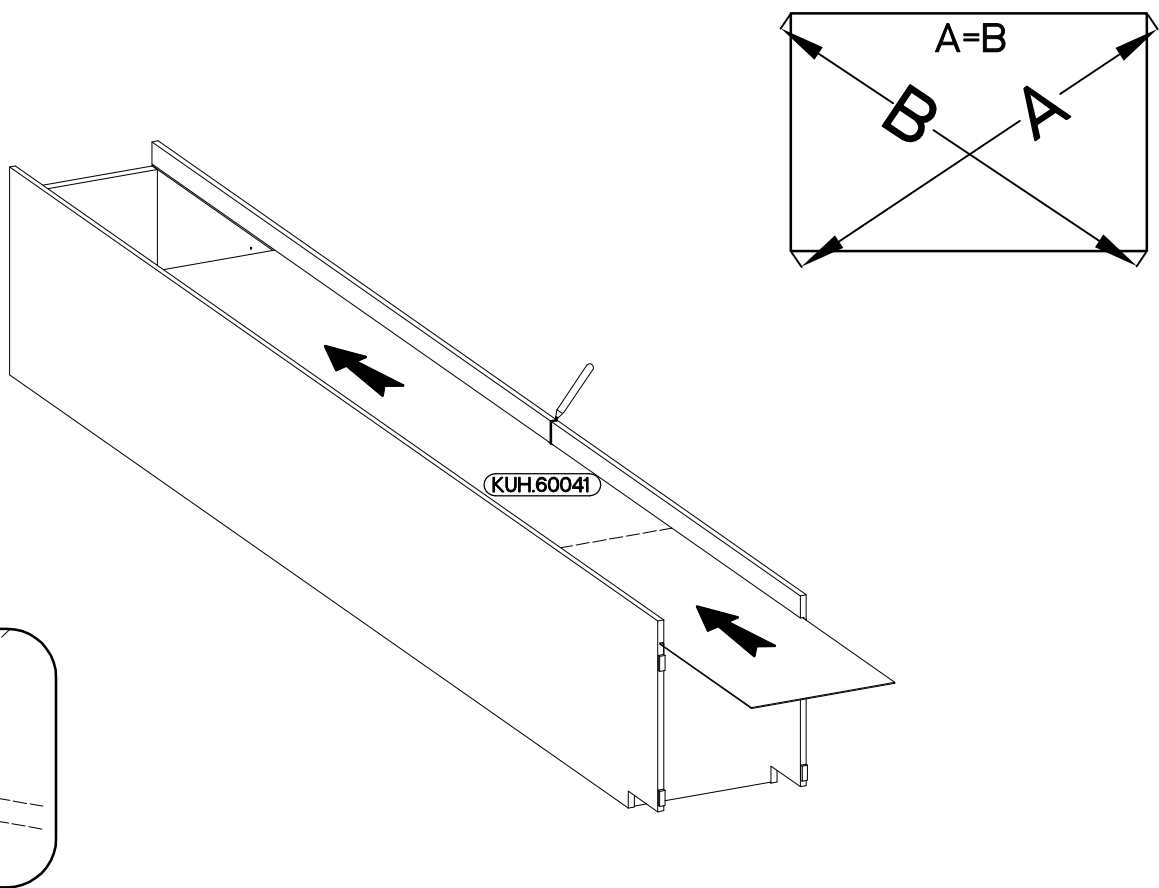

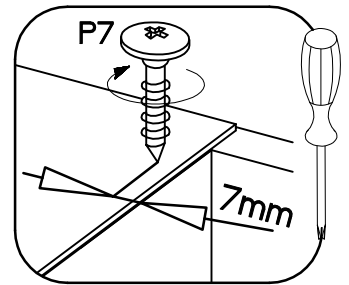
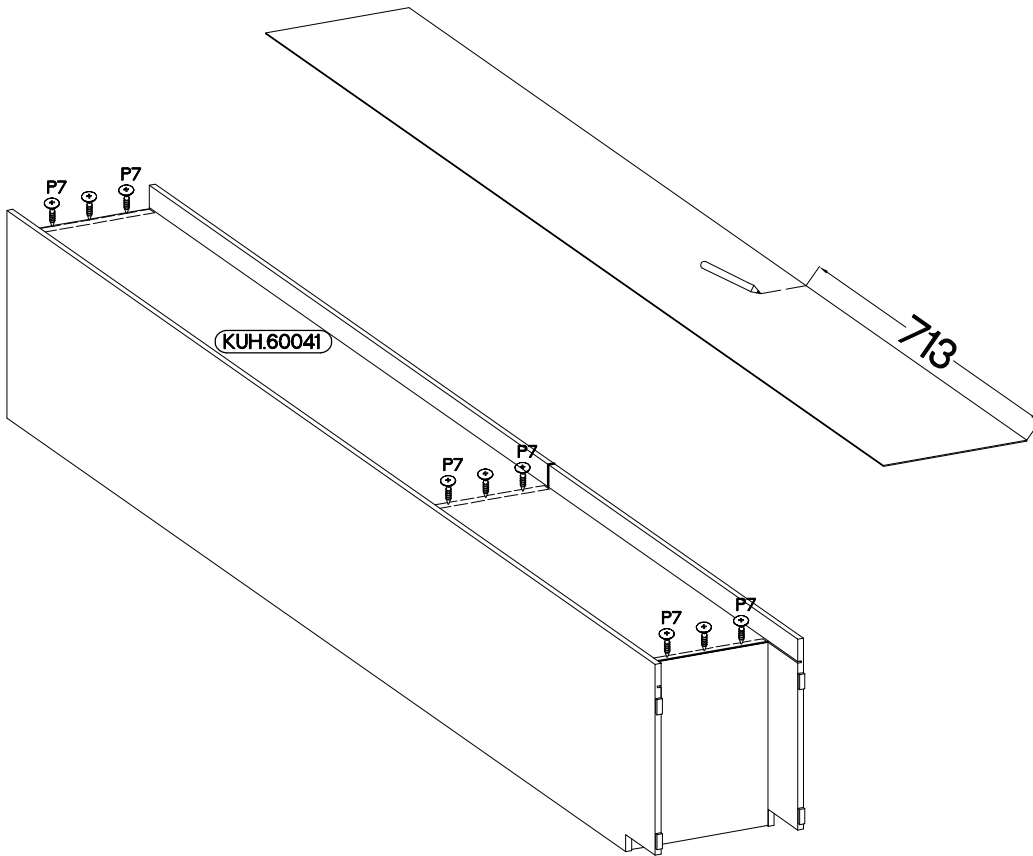
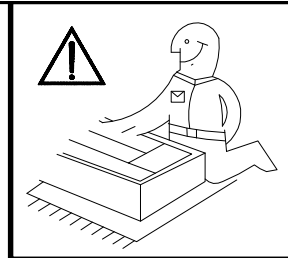

# 5

|  |
|--|
| φ3.0x20mm  |
|  |
| P7   |
| 10-15  |



# 6

|   |   |
|---|---|
| φ4.0x45mm   |  |
|  |  |
| P4  | E9  |
| 2   | 2   |

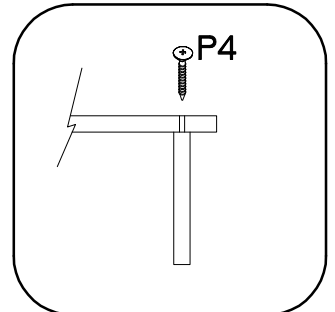
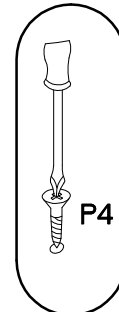
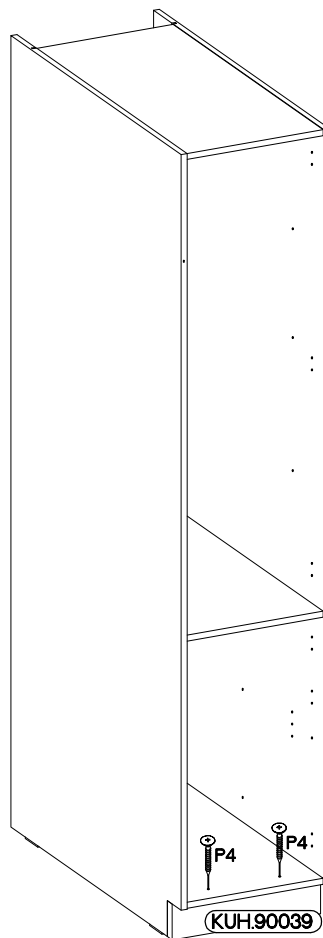

7

±5/19mm



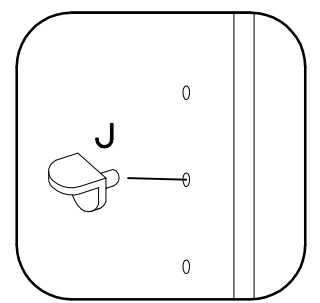
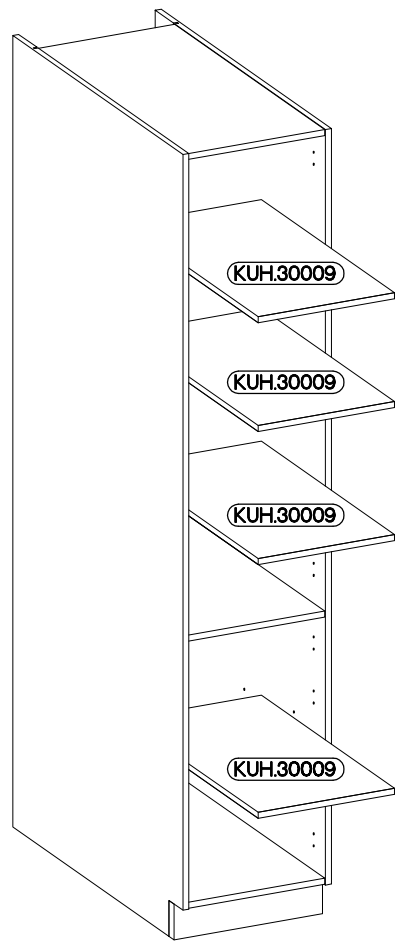

J

16



8

|   |   |
|---|---|
| 120x30x15mm   | ±3.5x13mm   |
|  |  |
| L25   | P5  |
| 1   | 2   |

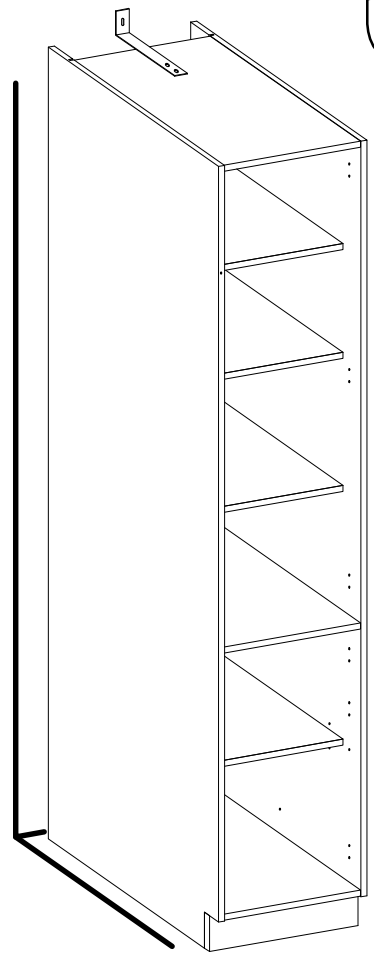

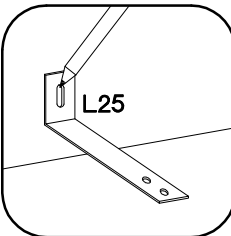
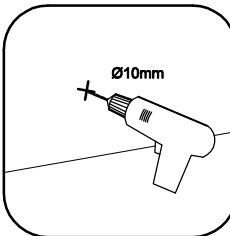
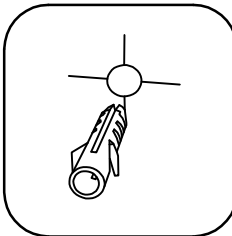
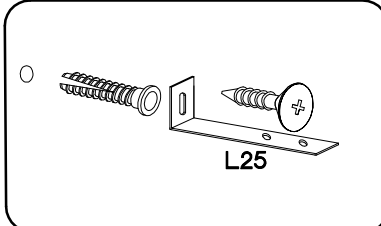
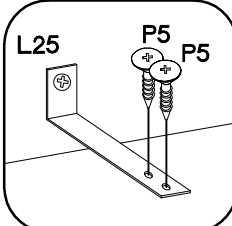
- 
- 
- 
- 
- 

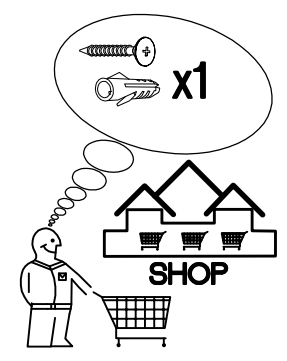
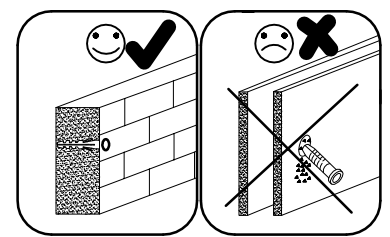

FRONT

