

60 DK-2100 2F
FRONT

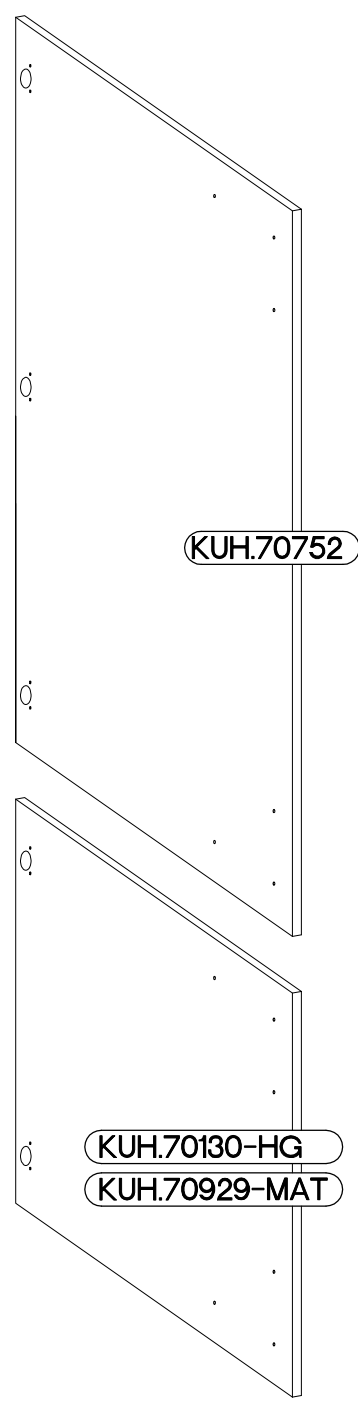

M4x22mm	L=128mm
U	S
4	2

ISM-KUH-01649

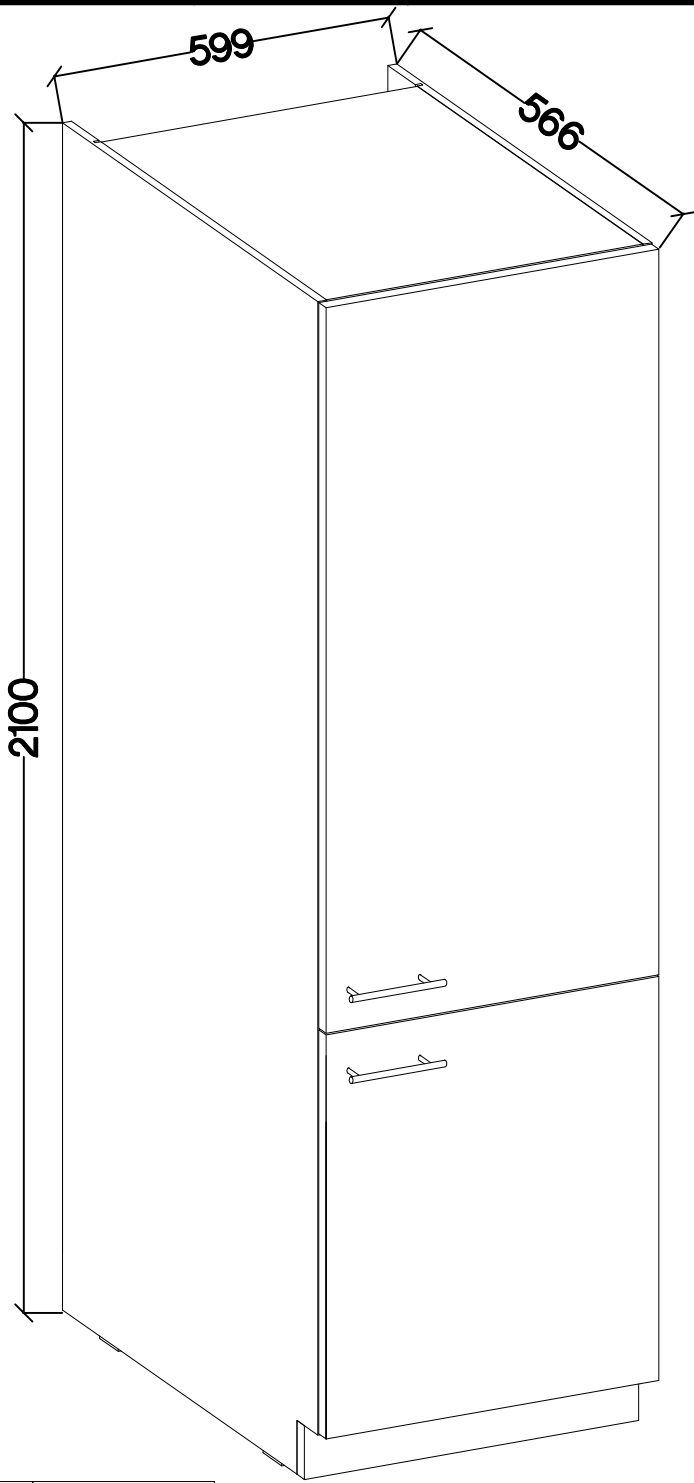
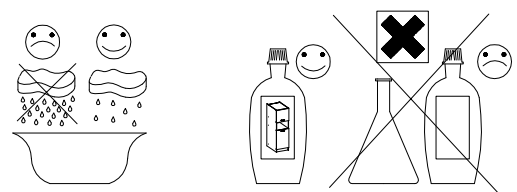



LEFT



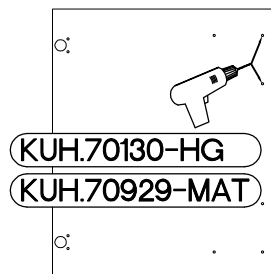
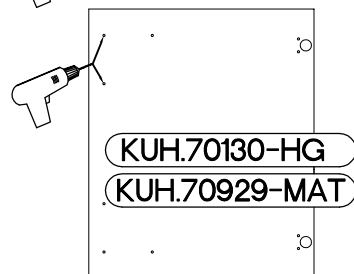
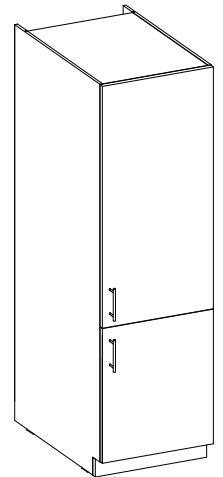
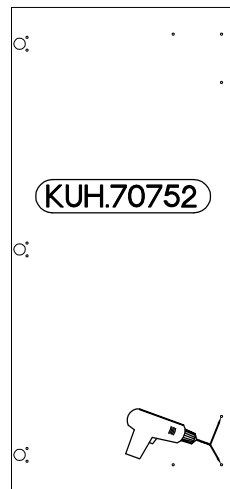
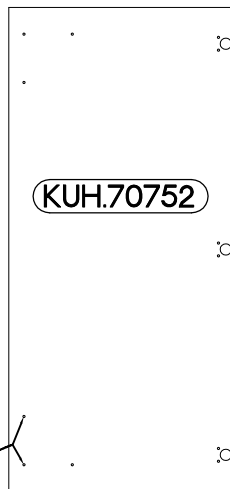
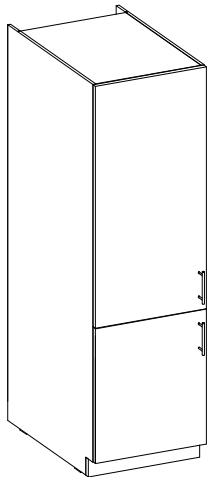
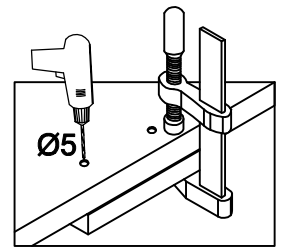
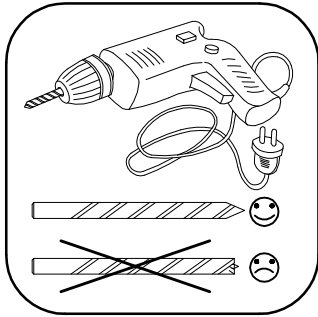
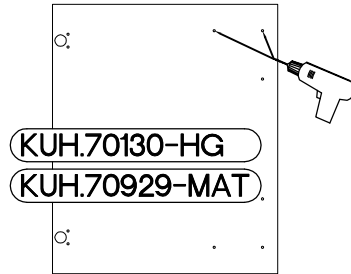
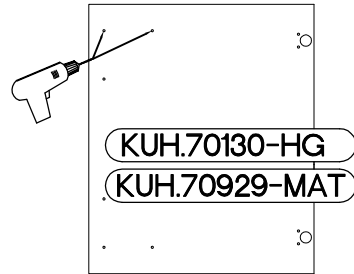
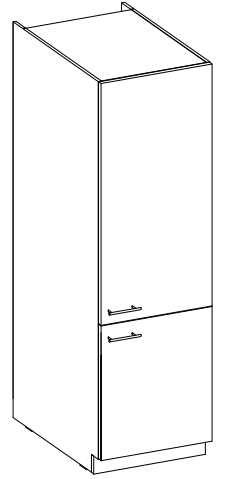
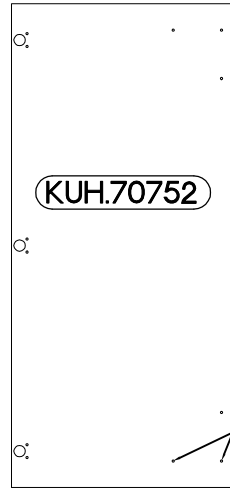
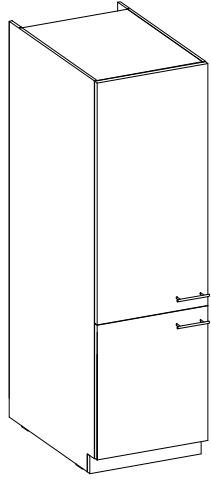

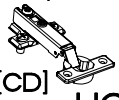
RIGHT

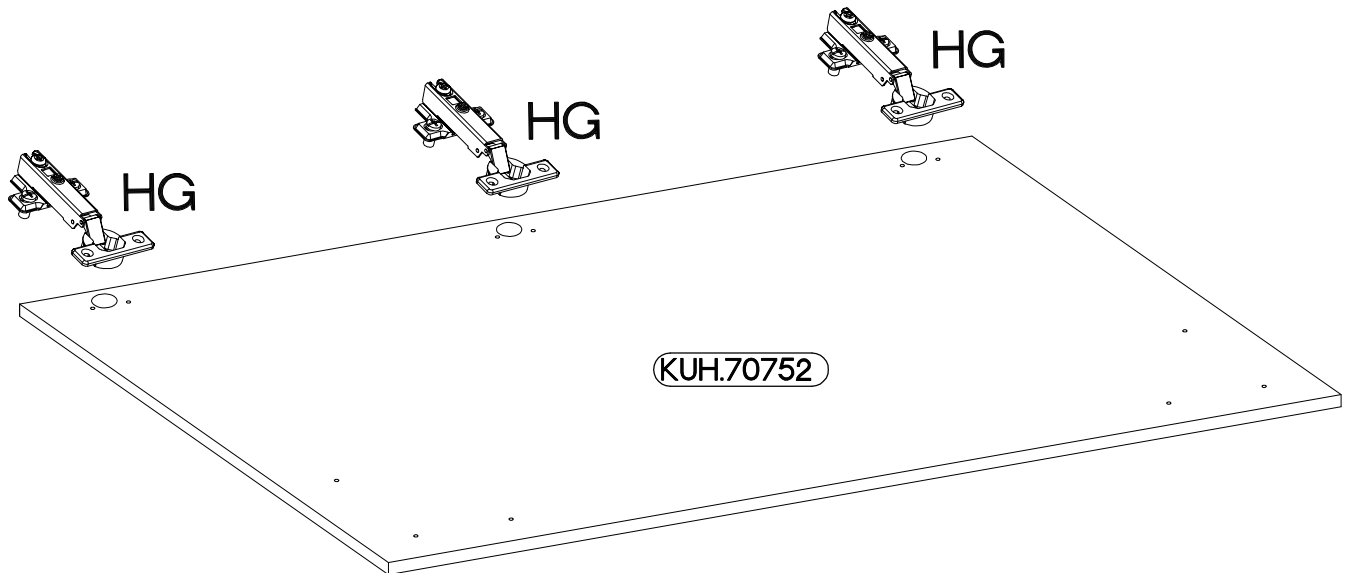
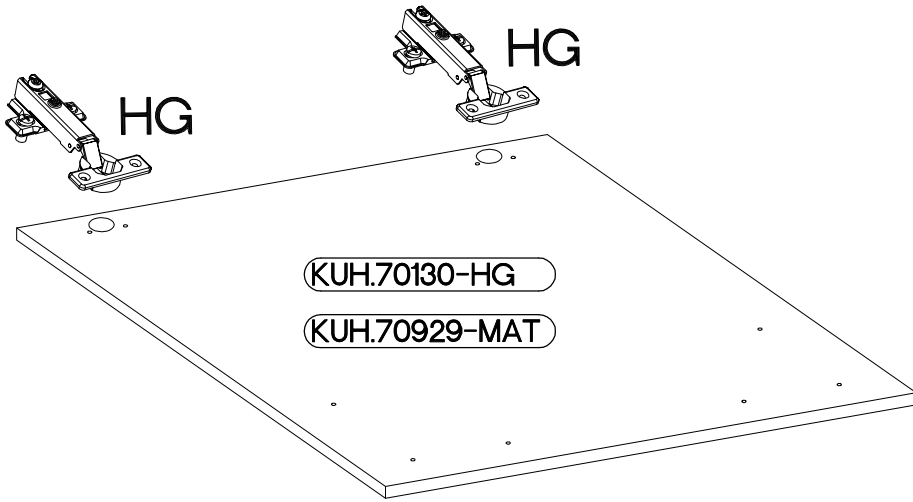
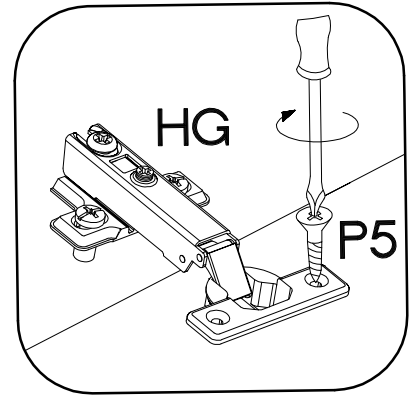

$\pm 35/0\text{mm}$  [CD] HG 5	$\pm 3.5 \times 13\text{mm}$  P5 10
-------------------------------------------------------------------------------------------------------------------------	------------------------------------------------------------------------------------------------------------------------------



3

M4x22mm	L=128mm
	
U	S
4	2

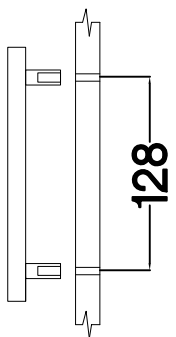
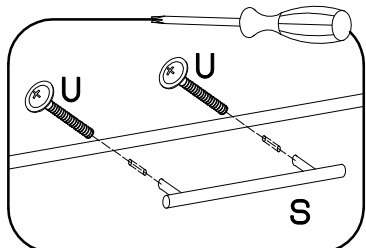
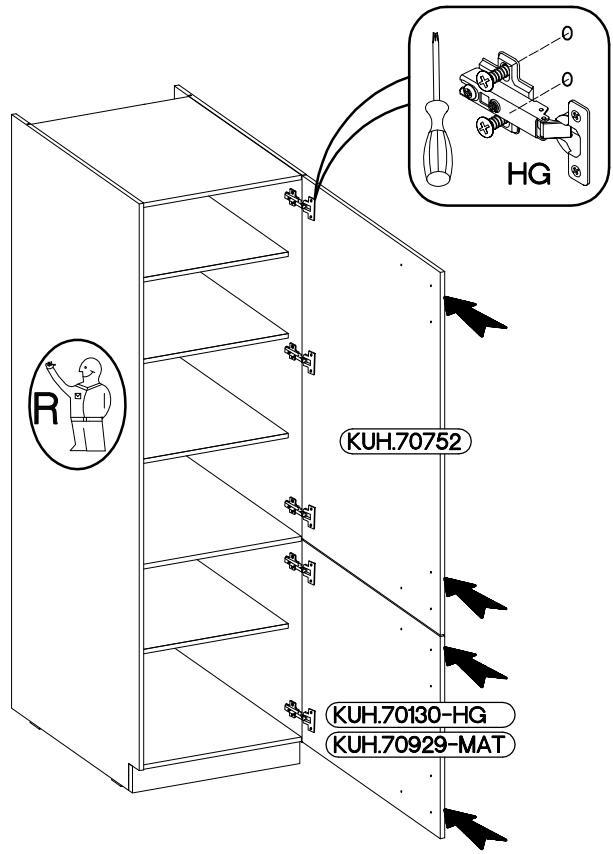
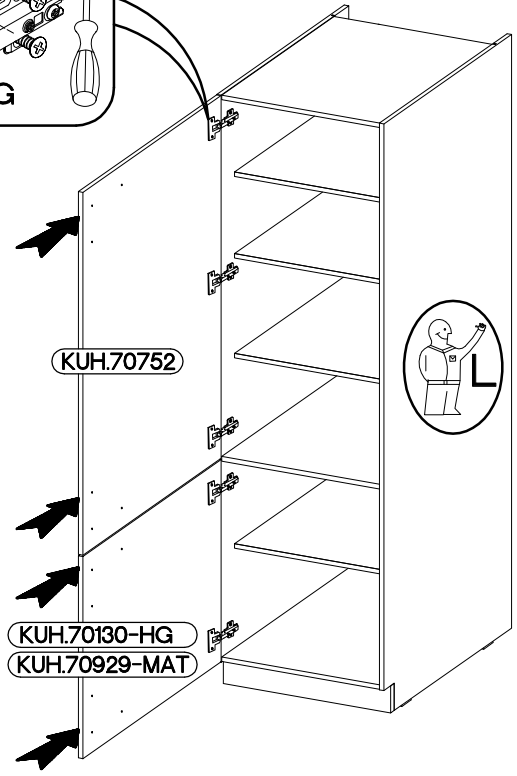
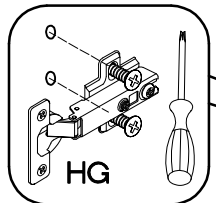

VARIANT HIGH GLOSS

