

896x296
FRONT

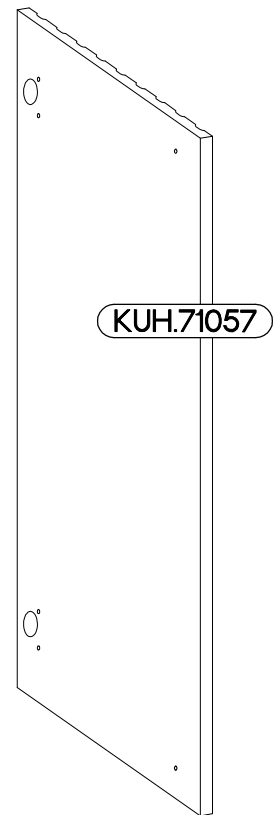
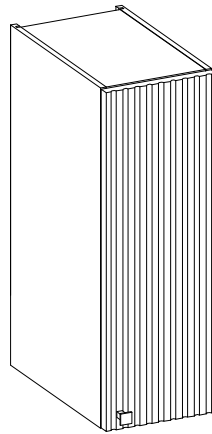
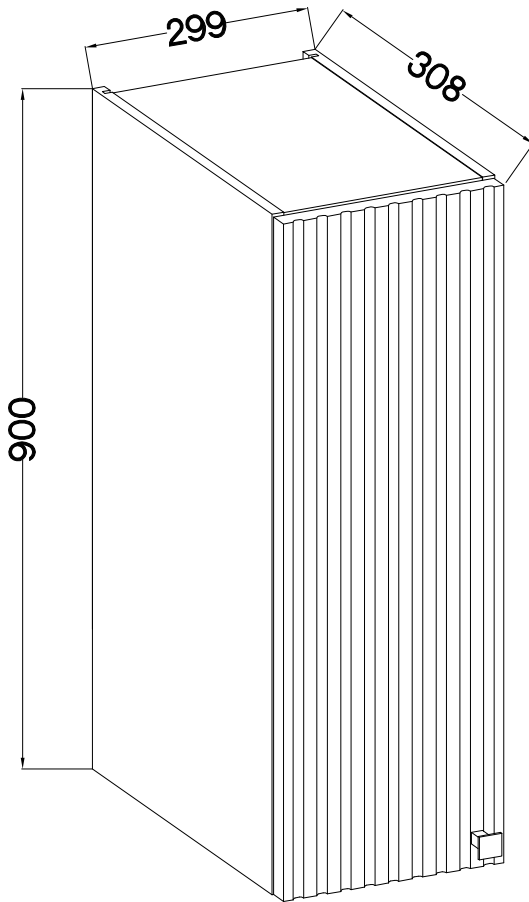
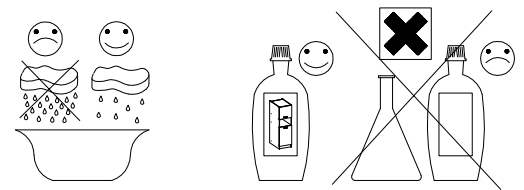

30x30mm	M4x22mm
S	U
1	1

Ersatzteil Nummer	Dimension
KUH.71057	896x296x18

ISM-KUH-01876



1

LEFT

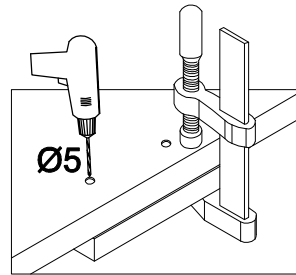
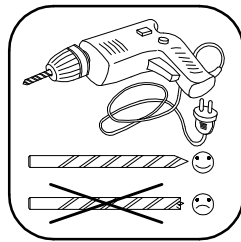
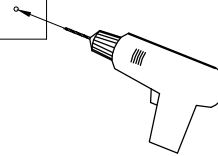
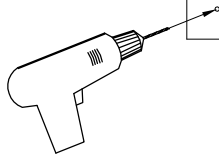
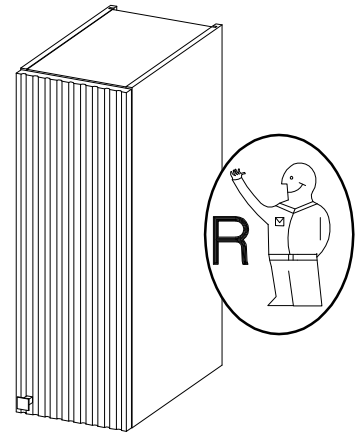
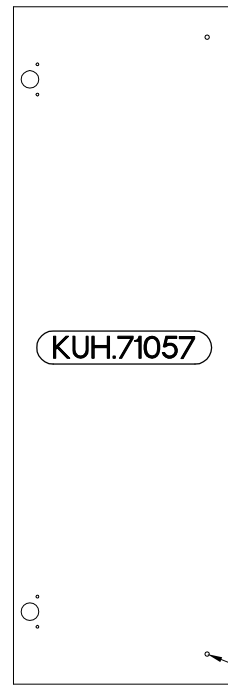
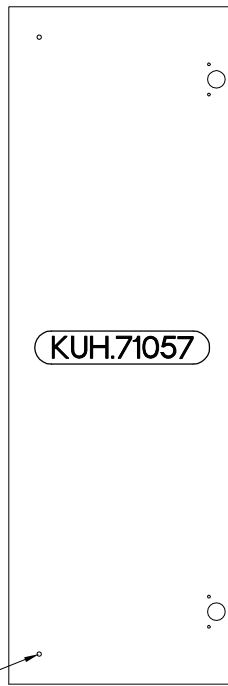
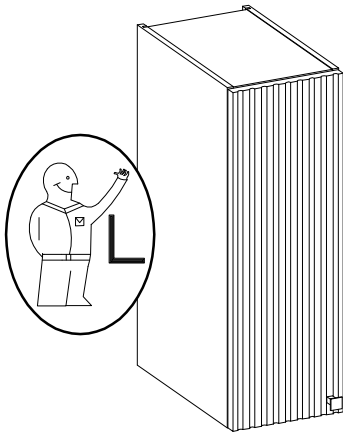

RIGHT

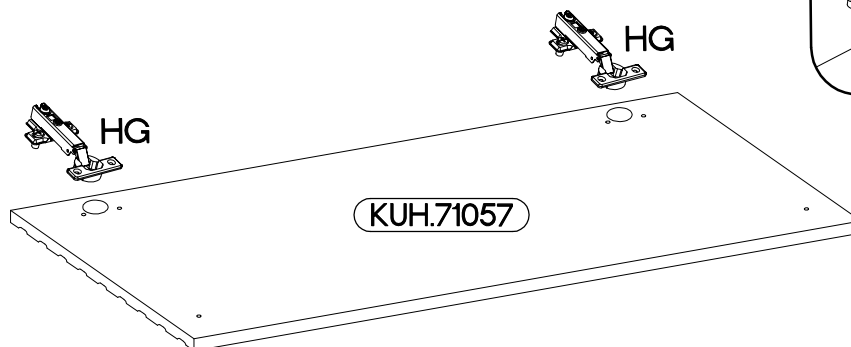
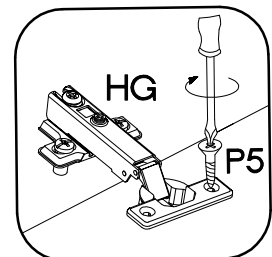

2

±35/0mm	±3.5x13mm
 [CD] HG	 P5
2	4



30x30mm	M4x22mm
	
S	U
1	1

